



GENERAL CARGO SECURING GUIDELINES FOR PULP AND PAPER PRODUCTS

Transport on road

according to the European standard EN 12195-1:2010

Contents	Page
1. INTRODUCTION AND PREAMBLE	3
2. BASIC CARGO SECURING PRINCIPLES.....	4
2.1 Designing acceleration forces.....	4
2.2 Method of cargo securing.....	4
2.3 Lashings.....	5
2.4 Lashing points	5
2.5 Cargo Transport Units (CTU).....	5
2.5.1 Side walls	5
2.5.2 Headboard	7
2.5.3 Rear wall	7
2.6 Pulp and paper products	8
2.7 Sliding.....	8
2.7.1 Friction factor	9
2.7.2 Determination of friction factor	9
2.7.3 Use of anti-slip material for standing paper reels.....	10
2.8 Tipping	11
2.8.1 Determination of effective breadth/length	12
3. GENERAL CARGO SECURING INSTRUCTIONS FOR PULP AND PAPER PRODUCTS.....	13
3.1 Cargo securing arrangements to prevent movements sideways.....	13
3.1.1 Sideways - blocking	13
3.1.2 Sideways - lashing.....	14
3.1.3 Sideways - blocking and lashing	14
3.2 Cargo securing to prevent movements in forward direction	15
3.2.1 Forward direction - one layer - blocking	16
3.2.2 Forward direction - one layer - lashing	17
3.2.3 Forward direction - one layer – blocking and lashing	17
3.2.4 Forward direction - multiple layers - blocking	18
3.2.5 Forward direction - multiple layers - lashing	19
3.2.6 Forward direction - multiple layers - blocking and lashing	20
3.3 Cargo securing to prevent movements in backward direction	20
3.3.1 Backward direction - one layer – blocking	21
3.3.2 Backward direction - one layer - lashing	21
3.3.3 Backward direction - multiple layers - blocking	22
3.3.4 Backward direction - multiple layers - lashing	23
4. HOW TO USE THE TABLES IN THE QUICK LASHING GUIDE.....	24
5. OTHER EQUIPMENT FOR CARGO SECURING	26
5.1 Edge protectors	26
5.2 Wedges	28
6. EXAMPLE.....	29
ANNEXES	
Annex I – Abbreviations and Acronyms.....	36
Annex II – List of Figures.....	37
Annex III - Quick Lashing Guide: Safe Load Securing for Road Transport – In accordance with EN 121951:2010.....	39

1. Introduction and Preamble

This document presents general cargo securing instructions for pulp and paper products and is produced in co-operation between CEPI - Confederation of European Paper Industries – and MariTerm AB. The guidelines are to be seen as industry best practices and will, when applied correctly, promote safe transport of paper products. The guidelines are meant for all persons involved in a transport chain that plan, prepare, supervise or check transport in order to ensure safe transportation. The guidelines are valid for transport on road and are based on the European standard EN 12195-1:2010 – *Load restraining on road vehicles – Safety – Part 1: Calculation of securing forces*. It is important to bear in mind that individual countries might have specific requirements - VDI guideline 2700 part 9 in Germany for instance - relative to cargo securing not covered in these instructions. It is therefore always necessary to consult the relevant authorities to enquire about the possible existence of such specific requirements. These cargo securing guidelines do not substitute relevant, valid regulations, laws and guidelines. Additional or deviating procedures might be required to ensure compliance to local regulations, or to meet requirements set by local conditions for traffic and infrastructure. Equally, deviations from these instructions might be necessary due to shape, consistency or any other properties of the products that are to be secured for transit.

These cargo securing guidelines lose their validity, if relevant national or international regulations and standards, especially the EN 12195-1, are amended.

The operations for loading and securing of the loads (positioning of anti-slip mats and edge protections, lashing and tensioning), and then for unloading, should always be undertaken in such a way that the safety of all the persons involved is guaranteed.

Note that this document may serve as a basic instruction directed to those with experience of cargo securing for further processing adapted to each specific company. Many different arrangements are shown and the cargo securing arrangement that best suits the actual product and cargo transport unit (CTU) is to be chosen.

These guidelines are intended to help all persons involved in a transport chain related to the pulp and paper industry to apply the European standard EN 12195-1:2010 – *Load restraining on road vehicles – Safety – Part 1: Calculation of securing forces*.

The users of these guidelines are encouraged to acquire this EU standard from the European standardisation body CEN or one of its National Standardisation Bodies.

Neither CEPI nor any person acting on CEPI's behalf can by any means be liable for non-compliance with the European standard EN12195-1:2010 resulting from the use of these guidelines and the information contained therein.

2. Basic cargo securing principles

The basic cargo securing principles, such as acceleration forces, lashing devices and friction factors, are described below.

Beyond that, the permitted load balancing as well as the axial load must be considered. These areas are not described in these cargo securing guidelines.

2.1 Designing acceleration forces

The cargo shall be secured against the following acting forces:

Figure 1. Acceleration forces

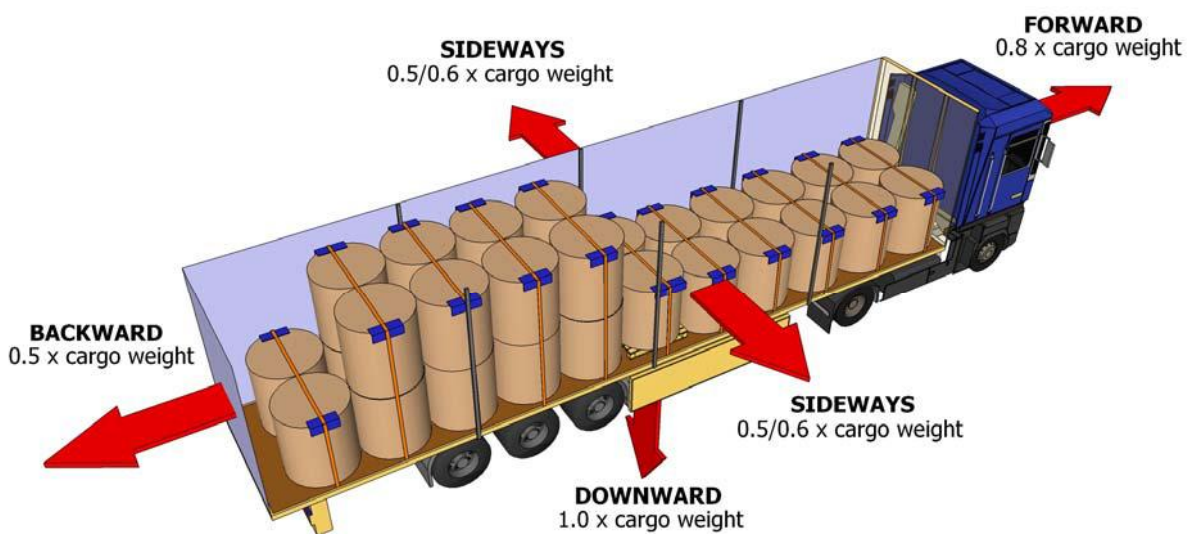

2.2 Method of cargo securing

The cargo shall be prevented from sliding and tipping in all directions by blocking or lashing or by a combination of these two methods. These instructions for pulp and paper products are based on the principles that are described in the European standard EN 12195-1:2010. **Note** that individual countries might have specific requirements relative to cargo securing that are not covered in these instructions, and it is therefore necessary to consult the relevant authorities to enquire about the possible existence of such specific requirements. Note that load securing regulations need to fulfill the requirements as referred to in paragraph 1 (Introduction and Preamble) for each individual country, and region within a country, where the load is in transit. It might be necessary to adapt to the maximum required load security level of any country or region for the whole duration of all transit.

2.3 Lashings

All arrangements in these instructions are based on lashings with a lashing capacity (LC) of at least 1600 daN (1 daN \approx 1 kg) and a standard tension force (S_{TF}) of **minimum 400 daN** during the entire transport. It is favourable with as high pre-tension (S_{TF}) as possible but please **note** that all products not always manage this. Therefore, the pre-tension should always be measured. For some paper grades, a pre-tension higher than 500 daN can cause edge damages to paper reels.

Figure 2. Typical content of webbing strap label, marked in accordance with EN 12195-2



Reference: SpanSet

The required number of lashings to prevent the cargo from sliding and tipping sideways, forward and backward is found in the Quick Lashing Guide, which is enclosed as an Appendix to these instructions. If the pre-tension is increased from 400 daN to 500 daN the values in the table in the Guide for top-over lashings will increase by 25 %.

2.4 Lashing points

The lashings points in the CTUs shall have a lashing capacity of at least 2000 daN.

2.5 Cargo Transport Units (CTU)

The cargo transport units, vehicles and swap bodies, should meet the requirements according to the European standards EN 12642, EN 12640 and/or EN 283.

The amount of cargo securing arrangement in the different CTUs depends on the type of cargo as well as the strength in side walls, headboard and rear wall. The trailer types marked in green in the sketches below have strong side walls, the yellow marked trailer has sides for bottom blocking only and the sides of the red marked trailer are to be regarded as weather protection only. Additional information for each type of trailer is outlined below.

Note that if the side walls are used for blocking cargo it is important that the number of slats according to the test certificate is used. The slats are to be placed so that the cargo weight is uniformly distributed over the full length of the sides. Also **note** that headboard, side walls and rear wall shall be used with caution for blocking of cargo which is exposed to the headboard/side walls/rear wall with a linear load, for example paper reels.

2.5.1 Side walls

The vehicles are grouped into the following categories depending on the strength in the side walls:

- EN 12642 code XL with strength 40 % of payload (0.4 P)
- EN 12642 code L with strength 30 % of payload (0.3 P)
- No strength at all; 0 % of payload

Side walls - EN 12642 code XL

If the side walls are built according to EN 12642 code XL the side walls are able to take up 40 % of the payload (0.4 P). The design acceleration sideways is 0.5 g. Thus, if the static friction factor is at least 0.1, the side walls are strong enough to withstand the sideway sliding forces. **Note** that curtain sides should be used with care if the forces from the cargo are not uniformly spread.

Side walls - EN 12642 code L



If the side walls are built according to EN 12642 code L the side walls in a box trailer are able to take up 30 % of the payload (0.3 P). The design acceleration sideways is 0.5 g. Thus, if the static friction factor is at least 0.2 the side walls are strong enough to withstand the sideway sliding forces. **Note** that side walls in a curtainsider built according to EN 12642 code L is regarded as a weather protection only.

Side walls - No strength

When cargo is transported in a cargo transport unit without strong sides, certificate or not proved, the entire cargo weight has to be secured against sideway movements by lashings for example according to the Quick Lashing Guide.

Comparison of strength requirements of CTU side walls, headboard and rear wall

Figure 3. Strength requirements of CTU side wall, headboard and rear wall

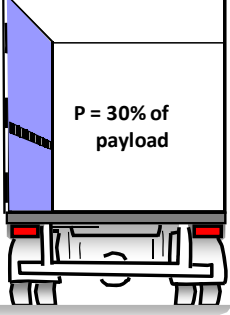
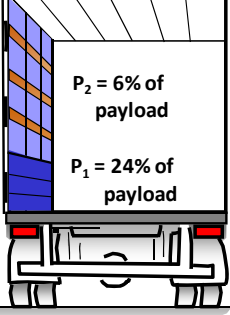
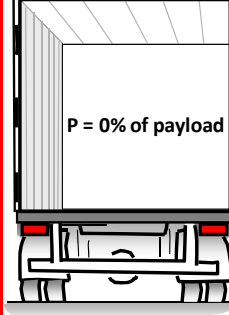
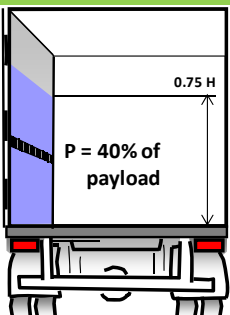
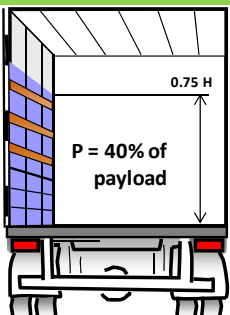
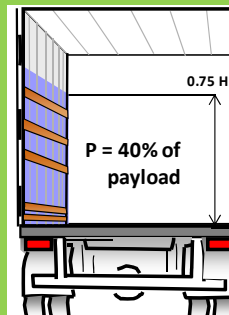
	BOX-TYPE TRAILER	COVER/STAKE TRAILER	CURTAINSIDER
			
EN 12642 code L			
	Headboard: P = 40 % of payload, maximum 5 tonnes Rear wall: P = 25 % of payload, maximum 3.1 tonnes		
EN 12642 code XL			
	Headboard: P = 50 % of payload Rear wall: P = 30 % of payload		

2.5.2 Headboard

The following strength in the headboard is possible (stowed tightly and uniformly):

- EN 12642 code XL with strength 50 % of payload (0.5 P)
- EN 12642 code L with strength 40 % of payload (0.4 P), maximum 5000 daN
- Unmarked CTU or cargo not stowed tightly against the headboard, 0 % of payload

Headboard - EN 12642 code XL

If the headboard is built according to EN 12642 code XL the headboard is able to take up 50 % of the payload (0.5 P). The design acceleration in forward direction is 0.8 g. Thus, if the calculated friction factor is at least 0.3 the headboard is strong enough to withstand the sliding forces in forward direction of a full payload.

Headboard - EN 12642 code L

Headboards built in accordance with EN 12642 code L are able to withstand a force corresponding to 40 % of the vehicle's payload (0.4 P). However, for vehicles with a payload of more than 12.5 tonnes, the strength requirement is limited to a force of 5000 daN. With respect to this limit the table below shows the cargo weight in tonnes that is permitted to be blocked against a headboard with a limited strength of 5000 daN for different friction factors. If the cargo weight is larger than relevant table value additional lashings are required.

Figure 4. Load weight prevented from sliding by a L headboard as function of the friction factor

Friction factor μ	Cargo weight possible to block against the headboard in forward direction (tonne)
0.15	7.8
0.20	8.4
0.25	9.2
0.30	10.1
0.35	11.3
0.40	12.7
0.45	14.5
0.50	16.9
0.55	20.3
0.60	25.4

Headboard - No strength

When cargo is transported in a cargo transport unit with a headboard with no strength, or when it is not stowed tightly against the headboard, the entire cargo weight has to be secured against forward movement by lashings according to the Quick Lashing Guide.

2.5.3 Rear wall

The following strength in the rear wall is possible:

- EN 12642 code XL with strength 30 % of payload (0.3 P)
- EN 12642 code L with strength 25 % of payload (0.25 P), maximum 3100 daN
- Unmarked CTU or cargo not stowed tight against the rear wall, 0 % of payload

Rear wall - EN 12642 code XL

If the rear wall is built according to EN 12642 code XL the rear wall is able to take up 30 % of the payload (0.3 P). The design acceleration in backward direction is 0.5 g. Thus, if the friction factor is at least 0.2 the rear wall is strong enough to withstand the sliding forces in backward direction of the full payload.

Rear wall - EN 12642 code L

Rear walls built in accordance with EN 12642 code L are able to withstand a force corresponding to 25 % of the vehicle's payload (0.25 P). However, for vehicles with a payload of more than 12.5 tonnes, the strength requirement is limited to a force of 3100 daN. With respect to this limit, the table below shows the cargo weight in tonnes that is permitted to be blocked against a rear wall with a limited strength of 3100 daN for different friction factors. If the cargo weight is larger than the relevant table value, additional lashings are required.

Figure 5. Load weight prevented from sliding by a L- rear wall as function of the calculated friction factor

Friction factor μ	Cargo weight possible to block against the rear wall in backward direction (tonne)
0.15	9.0
0.20	10.5
0.25	12.6
0.30	15.8
0.35	21.0
0.40	31.6

Rear wall - No strength

When cargo is transported in a cargo transport unit with a rear wall with no strength or when it is not stowed tightly against the rear wall, the entire cargo weight has to be secured against backward movement by lashings according to the Quick Lashing Guide.

2.6 Pulp and paper products

These instructions consider the following product types:

1. Standing reels with eye to sky
2. Lying reels with eye to side
3. Lying large reels with eye forward
4. Pallets of sheeted paper
5. Pallets with tissue paper rolls (light weight and height > 2 m)
6. Packages of pulp bales

A solid load unit is required for transporting pulp and paper products. This must be equally suitable for transport, handling and storage.

2.7 Sliding

In many cases, sliding is prevented by means of friction between the contact surfaces or by a combination of friction and lashing. Different material contacts have different friction factors.

2.7.1 Friction factor

The table below shows recommended values for the (calculated) friction factor (92.5% of the static friction) taken from the European standard EN 12195-1:2010. The friction factor is valid if the contact surfaces are dry or wet, swept clean and free from frost, ice and snow. In other cases the general friction factor $\max \mu = 0.2$ for road transport and $\max \mu = 0.3$ for sea transport should be used. It has to be ensured that the used friction factors are applicable for the actual transport.

Note that any value for the friction factor for paper reels or pulp is not mentioned in the European standard. If the friction is not measured and rubber mats are not used, the friction factor thus is $\max \mu = 0.2$ for road transport and $\max \mu = 0.3$ for sea transport.

Figure 6. Material combination in contact surface and calculated friction factor

Material combination in contact surface	Friction factor μ , dry or wet
SAWN TIMBER/WOODEN PALLET	
Sawn wood - fabric base laminate/plywood	0.45
Sawn wood - grooved aluminium	0.40
Sawn wood - shrink film	0.30
Sawn wood - stainless steel sheet	0.30
PLANED WOOD	
Planed wood - fabric base laminate/plywood	0.30
Planed wood - grooved aluminium	0.25
Planed wood - stainless steel sheet	0.30
PLASTIC PALLETS	
Plastic pallet - plywood/plyfa/wood	0.20
Plastic pallet - grooved aluminium	0.15
Plastic pallet - smooth steel sheet	0.15
Anti-slip material	
Rubber	0.60
Other material*	as certified*

**) When special materials for increased friction are applied, a certificate about the friction factor μ is required.*

Source: EN12195-1

The above table is taken from the EN 12195-1 and lists only a limited number of materials. Friction coefficients for paper have to be used on a "as certified" basis. The friction coefficient will depend on product type and truck floor conditions.

In case of direct lashings (loop, spring and straight lashings), where the cargo may move a little before elongation of the lashings provides the desired restraint force, the dynamic friction applies, which is to be taken as 75 % of the friction factor. This effect is included in the lashing tables in the Quick Lashing Guide.

2.7.2 Determination of friction factor

Two alternative methods are given in the standard for determination of friction factors; inclination or pulling tests.

The inclination test means that μ between the cargo and the floor is obtained by inclination of a platform until the cargo starts to slide and the angle of inclination, α , is measured. The friction factor is given by $\mu = 0.925 \times \tan \alpha$. Five tests have to be done and the highest and lowest result shall be ignored. The medium of the three remaining values is the friction to be used.

Figure 7. Practical inclination tests for determination of the friction.



7a. Inclination test for determination of the friction between the reel and the platform floor



7b. Inclination test for determination of the friction between the reels

The conditions for implementing the pulling test are found in EN 12195-1:2010, Annex B.

Note that the basic conditions and test results of practical tests should be documented according to instructions in EN 12195-1:2010, Annex E. Practical inclination tests may be carried out by anyone, directly at the site with for example a lorry with a tilting platform and an instrument for measuring the inclination angle.

Measured friction factors for material contacts not found in the table above may be used for the design of cargo securing arrangements.

2.7.3 Use of anti-slip material for standing paper reels

Only use anti-slip material for which the manufacturer guarantees or demonstrates (measured and documented) a coefficient of sliding friction of at least $\mu = 0.6$.

Suitability of the anti-slip material must have been demonstrated in field trials. For reasons of safety, anti-slip material should be used only once, unless multi-use is expressly approved by the manufacturer.

Anti-slip mats should be at least 150 mm in width. A minimum of two strips should be laid on the platform bed, in the longitudinal direction of the vehicle. The length of both strips should protrude from the reels to ensure that the friction factor is achieved.

Figure 8. Positioning of anti-slip material for standing reel to apply friction in- forward and backward direction (seen from the top)

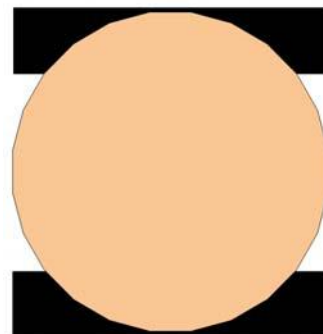

8a.

Note that the outer edges of the reels must come to lie on the anti-slip material in such manner that the anti-slip material protrudes by approximate at least 1 cm.

The last reels in the row must additionally be secured against backward slipping, e.g. by means of form-locking (to the rear) or by placing anti-slip material ($\mu \geq 0.6$) under the rear reel as well in order to prevent the reel from touching the floor when the vehicle is tipped backwards.

When positioning the anti-slip material, a strict safe working procedure must be in operation that prevents any loading of material during the positioning of the anti-slip material.

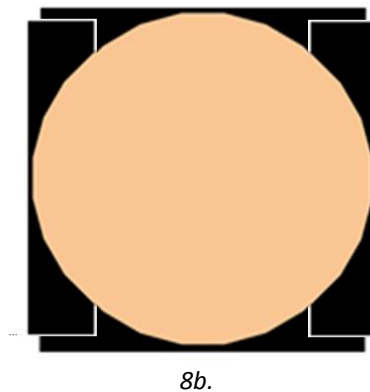
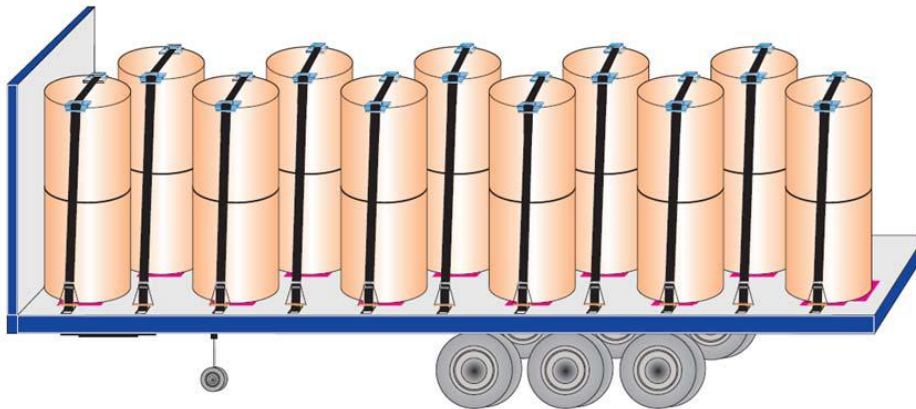

Figure 9. Load in “zig-zag” positioning with the proper lashing option



2.8 Tipping

The risk of tipping for a single cargo unit or a stack of units is determined by dividing the height, H, by the breadth, B, or length, L, of the cargo unit or stack of units. During road transport there is a tipping risk if:

- Sideways: $H/B > 2$
- Forward: $H/L > 1.25$
- Backward: $H/L > 2$

Figure 10. Definition of H/B/L of the cargo unit for tipping

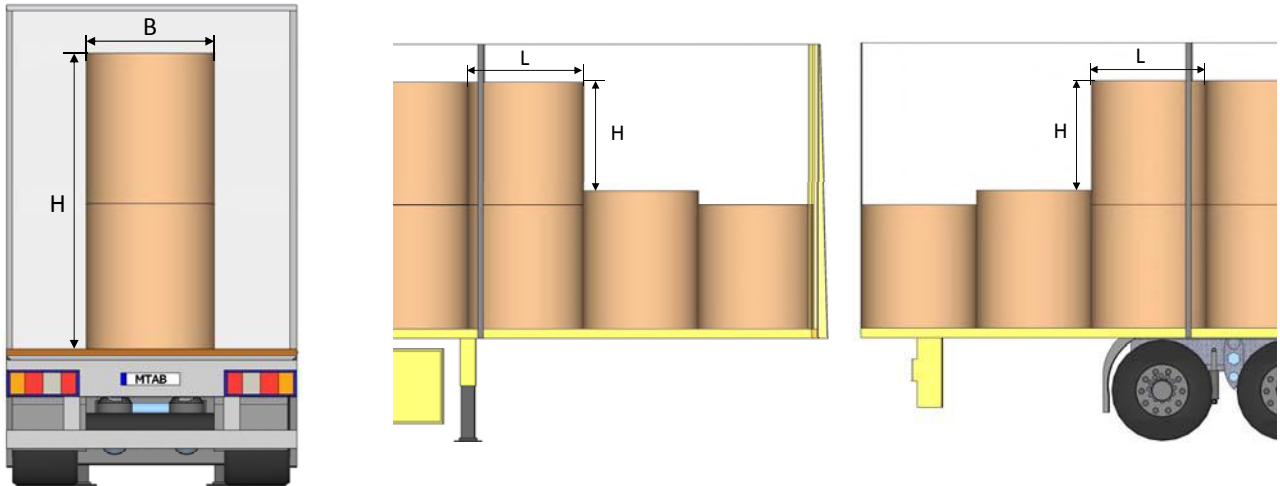

10a. Definition of H/B for tipping sideways

10b. Definition of H/L for forward tipping

10c. Definition of H/L for backward tipping

Note that it is the effective breadth/length to be used in the formulas above. The measurement of the effective breadth/length is explained below.

2.8.1 Determination of effective breadth/length

If the cargo is not rigid in form (reels, bales, etc.) and there is uncertainty of the effective breadth/length, the cargo can be tested by an inclination test. The effective breadth/length is calculated as $H \times \tan \alpha$, where α is the tipping angle measured from the inclination test.

Figure 11. Practical inclination test.



11a.



11b.

Inclination test for determination the effective breadth/length

For example, a reel with the diameter 900 mm (B or L) and the width 1330 mm (height H) should tip at an inclination of 34.1° ($\arctan(900/1330)$). Rubber is put underneath the reel so that the reel will tip before it slides. The reel tips at an inclination of 30.7° and shows that the effective diameter is 790 mm ($1330 \times \tan 30.7$) instead of the actual 900 mm. This means that the reel is somewhat soft in the outer edges and that 88 % ($790/900 = 0,877 \approx 88\%$) of the diameter of the reel only is to be regarded in the design of cargo securing arrangement to prevent tipping.

3. General cargo securing instructions for pulp and paper products

General cargo securing instructions to prevent sideways, forward and backward movement of pulp and paper products are described below. **Note** that the level of cargo securing arrangement for blocking and/or lashing of cargo depends on the strength of the side walls, headboard and rear wall. The blocking arrangement shall be adapted to the actual CTU as well as required number of lashings to the tables according to the Quick Lashing Guide and the lashing capacity (LC) and pre-tension (S_{TF}) in the securing device. Also **note** that each section is dealing with one direction only; sideways, forward **or** backward, and that the cargo securing arrangement may need to be complemented to be sufficient for all movements in all directions.

3.1 Cargo securing arrangements to prevent movements sideways

The cargo securing arrangement to prevent movement in sideway direction depends on the strength in the sidewalls. The following alternatives are covered below:

- CTUs with strong sides
- CTUs with sides for bottom blocking only
- CTUs with no strength in sides

Note that the sketches below show cargo securing arrangements to prevent sideway movements only and that blocking or lashing may be required for forward/backward movements.

If the cargo is blocked against strong walls without any free space sideways no securing is required for sideway movements. **Note** that CTUs marked in yellow in section 2.4 have sides suitable for bottom blocking only and lashing may be required for an upper layer and/or to prevent tipping.

Figure 12. Blocking against sidewalls

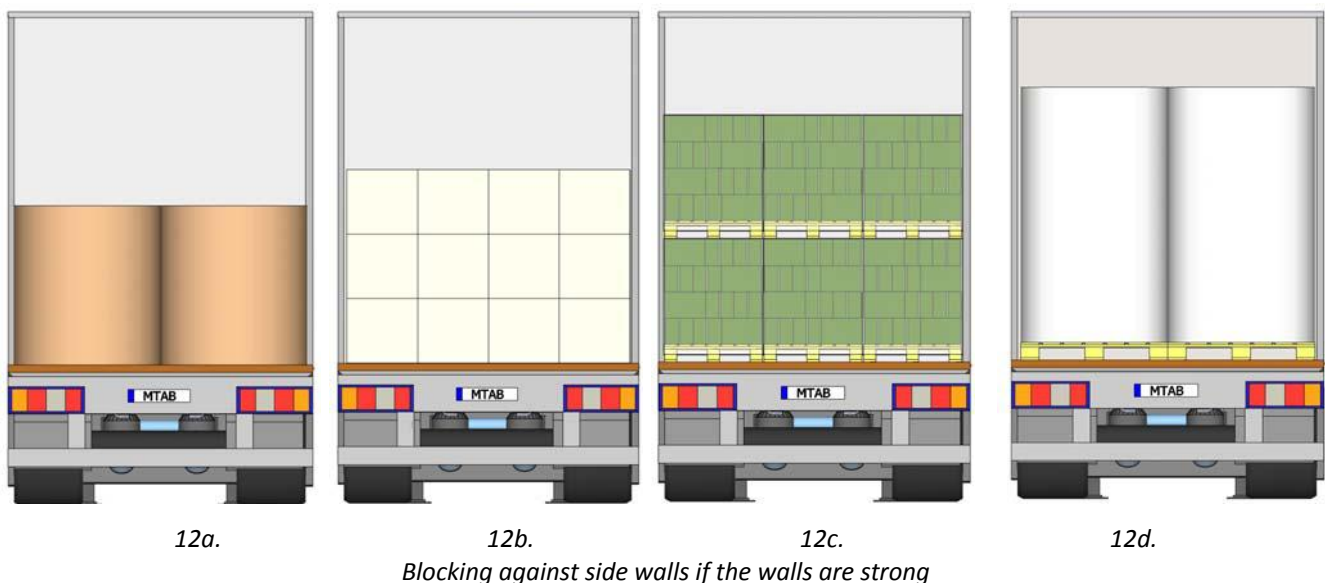

3.1.1 Sideways - blocking

Any free void space in the transverse direction is to be filled out by empty pallets, dunnage bags etc. **Note** that a blocking arrangement should have a height of at least 50 mm to prevent sliding.

3.1.2 Sideways - lashing

If blocking is not possible the cargo must be lashed to prevent both sliding and tipping sideways.

Figure 13. Sideways lashing

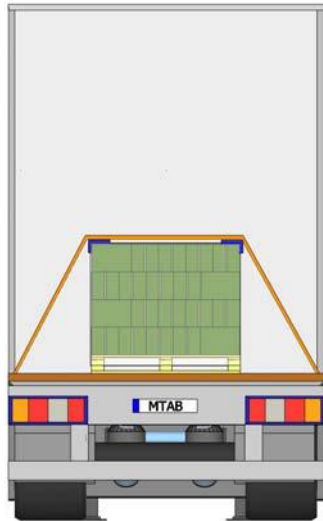

13a. Top-over lashing; the lashing angle has to be considered, see section 4

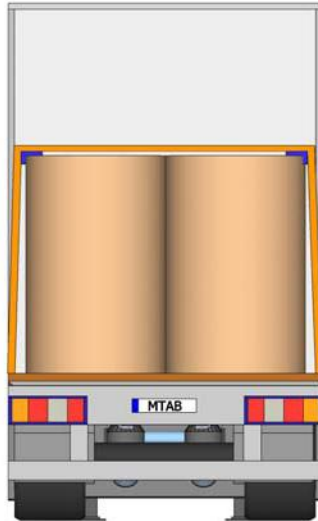

13b. Top-over lashing

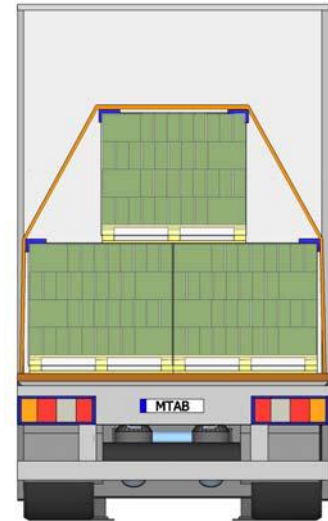

13c. Lashing of a second layer with top-over lashing; the lashing angle has to be considered, see section 4

3.1.3 Sideways - blocking and lashing

Figure 14. Sideways blocking and lashing

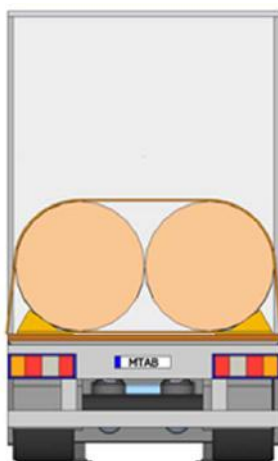

14a.

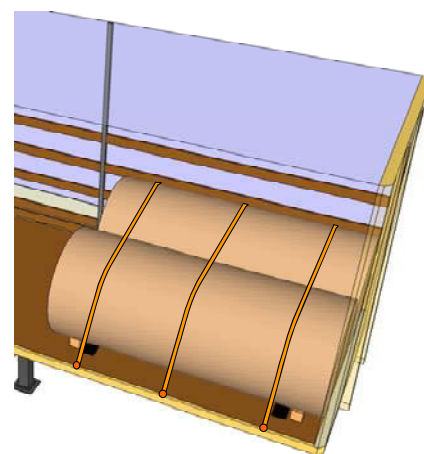

14b.

A combination of lashing and blocking with wedge beds for lying large reels with eye forward

Securing of lying large reels with eye forward is blocked by wedges sideways and secured by the required number of top-over lashings according to the Quick Lashing Guide, see Appendix. Also spring lashings may be needed to prevent forward movements depending on the friction factor. Preferably, rubber (in the sense of Anti-Slip Material) is put underneath as well as in the wedge beds.

Figure 15. Securing of lying large reels with eye forward

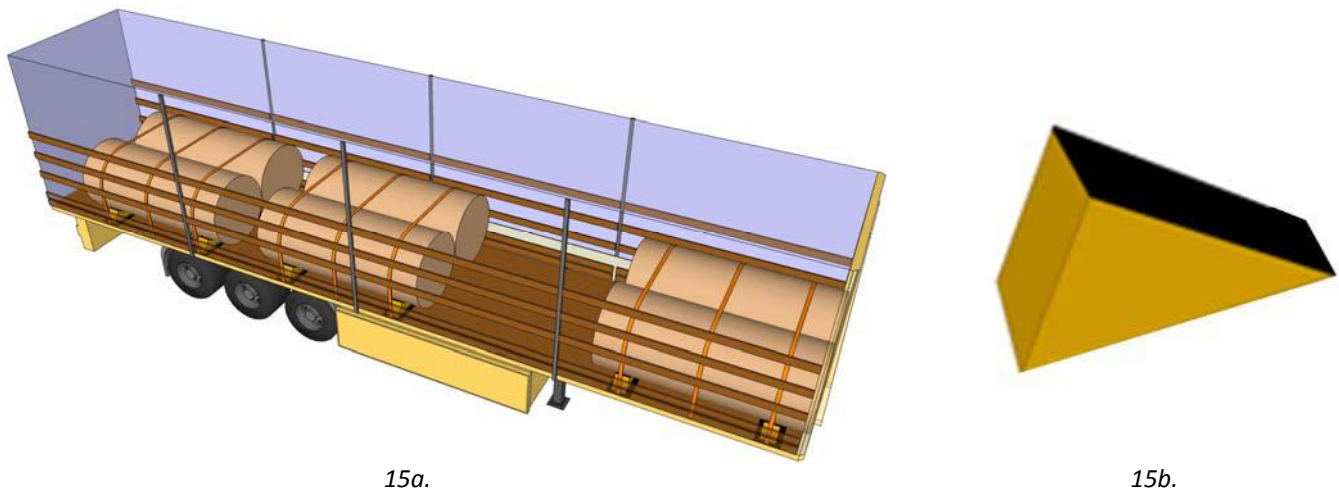

*Securing of lying large reels with wedge beds for blocking sideways and required number of top-over lashings.
Spring lashings may be required to prevent forward movements depending on the friction factor.
Preferably, rubber is put underneath as well as in the wedge beds.*

3.2 Cargo securing to prevent movements in forward direction

The required securing arrangement to prevent movements in the forward direction depends on the cargo weight, friction factor and the strength in the headboard. The following headboard alternatives are possible:

- EN 12642 code XL with strength 50 % of payload (0.5 P)
- EN 12642 code L with strength 40 % of payload (0.4 P), maximum 5000 daN
- Unmarked CTU or cargo not stowed tightly against the headboard, 0 % of payload

The cargo should, as far as possible, be stowed tightly against the headboard. If the cargo is stowed in multiple layers which are not blocked against the headboard, the cargo also has to be secured by further means, such as lashings or filling material to prevent it from sliding and/or tipping forward.

If the cargo is blocked against the headboard with sufficient strength without any free space, no additional securing is required in forward direction. See the table in section 2.4.2 for possible cargo weight to be blocked against a headboard built according to EN 12642 code L.

Note the sketches below show cargo securing arrangements to prevent forward movements only and that blocking or lashing may be required for sideways/backward movements.

Figure 16. Blocking against headboard

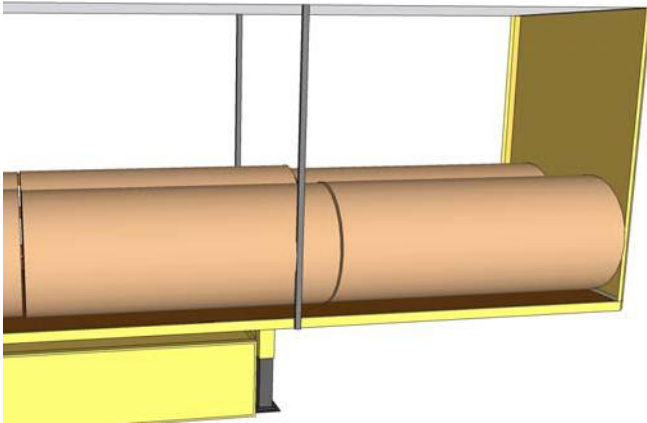

16a. Lying reels

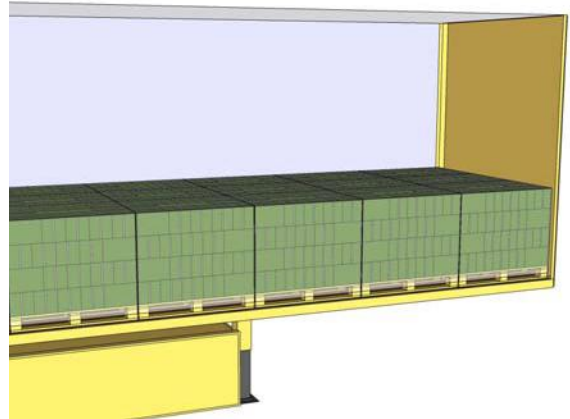

16b. Pallets

Blocking against headboard with sufficient strength

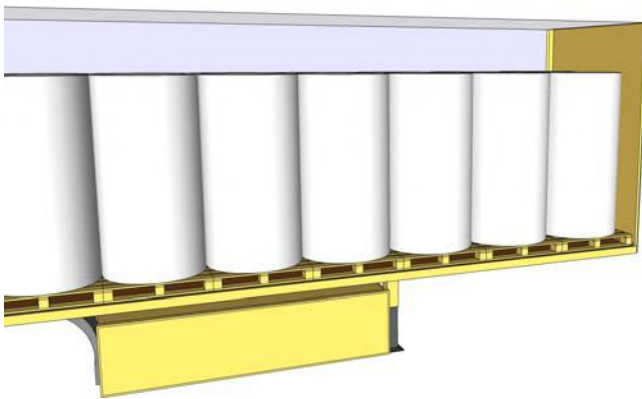

16c. Standing reels on pallets

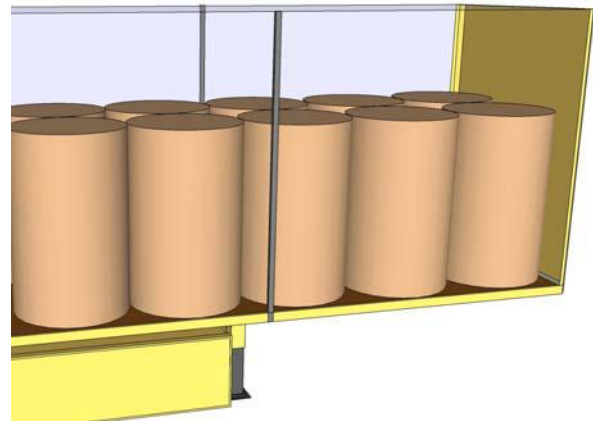

16d. Standing reels

3.2.1 Forward direction - one layer - blocking

Any free space is to be filled out with empty pallets, dunnage bags etc.

Figure 17. Forward direction - blocking

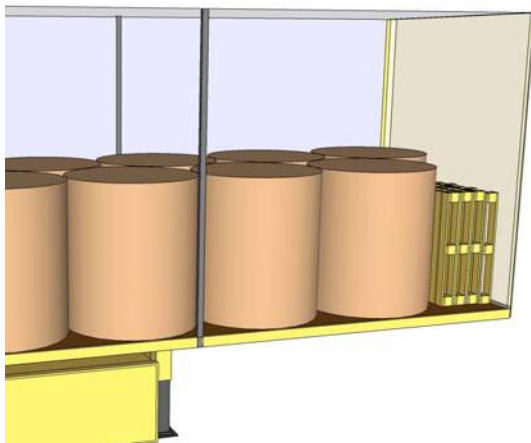

17a. Blocking by empty pallets

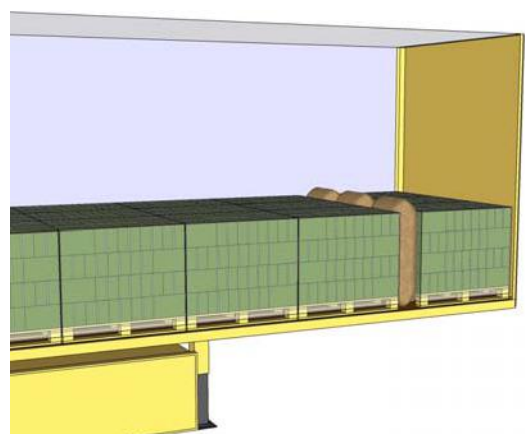

17b. Blocking by dunnage bags with sufficient strength

Alternatively, to prevent sliding and tipping forward, the cargo can be stowed in accordance with Figure 18.

Figure 18. Forward direction – stowage

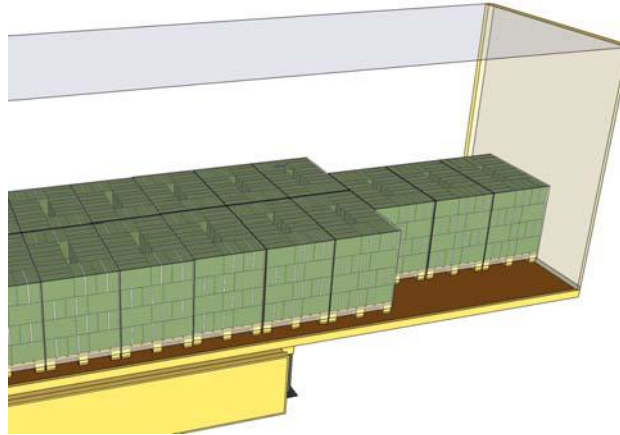

Stowage pattern to prevent sliding and tipping in forward direction

3.2.2 Forward direction - one layer - lashing

If the CTU is unmarked or if due to weight distribution the cargo is not stowed tightly against the headboard and backward, the cargo must be secured by lashings to prevent forward movement.

Figure 19. Forward direction - one layer – lashing

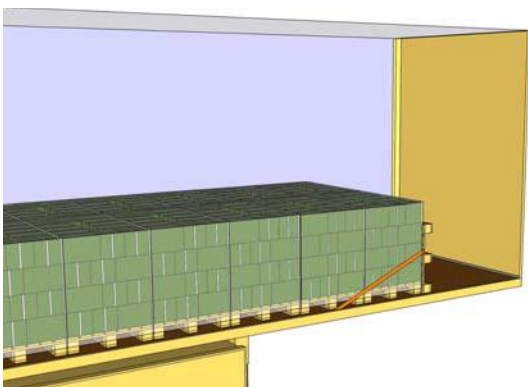

19a. Securing by spring lashing in forward direction

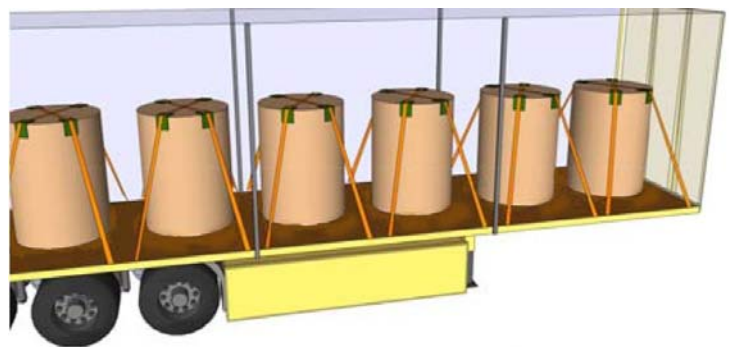

19b. Securing by top-over lashings to prevent inter alia forward movement

3.2.3 Forward direction - one layer – blocking and lashing

If the CTU is unmarked or if due to weight distribution the cargo is not stowed tightly against the headboard, the cargo may be secured by a combination of blocking and lashing to prevent forward sliding and tipping.

Figure 20. Forward direction – combination of blocking and lashing

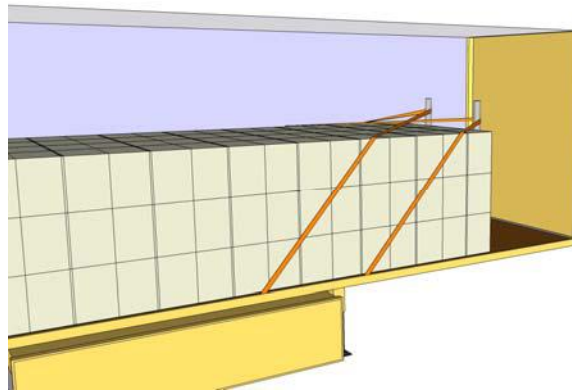

Combination of blocking and lashing; blocking by stanchions and supporting lashings

3.2.4 Forward direction - multiple layers - blocking

The bottom layer must always be blocked against the headboard or blocked by pallets, dunnage bags etc. and/or lashed.

If the multiple layers are not blocked against the headboard, the multiple layers may be bottom blocked by the bottom layer. A threshold of minimum 50 mm (up on the cargo if palletised cargo) made of cargo from the bottom layer/layers with either different heights or raised by timber or pallets. Blocking may also be done by panel/fence if this is strong enough.

Figure 21. Forward direction – multiple layers blocking

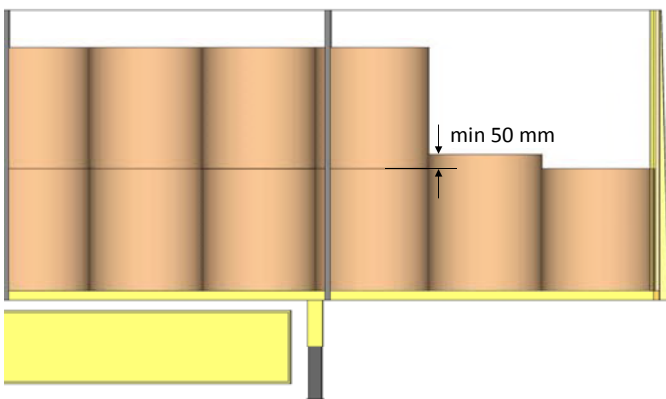

21a. Blocking of a second layer with reels of different height

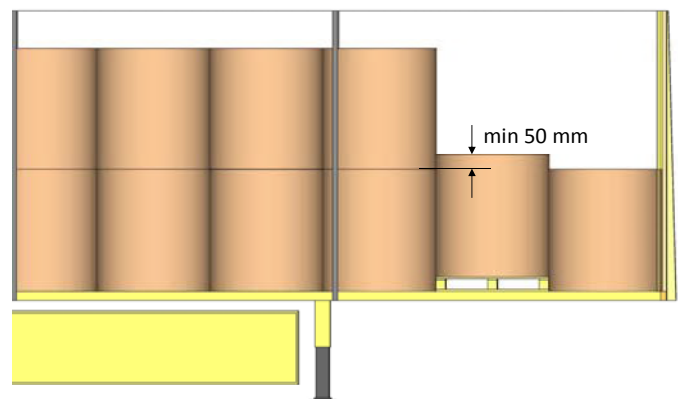

21b. Blocking of a second layer by bottom layer raised by pallets or battens

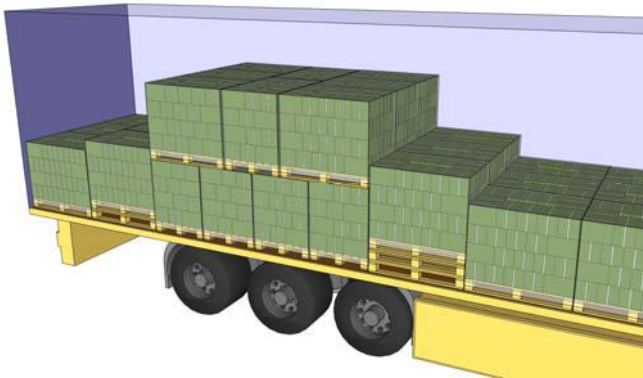

21c. Blocking of second layer by a threshold created by raising the bottom layer with extra pallets. This can be applied if there is no tipping risk and if the cargo is well attached to the pallet.

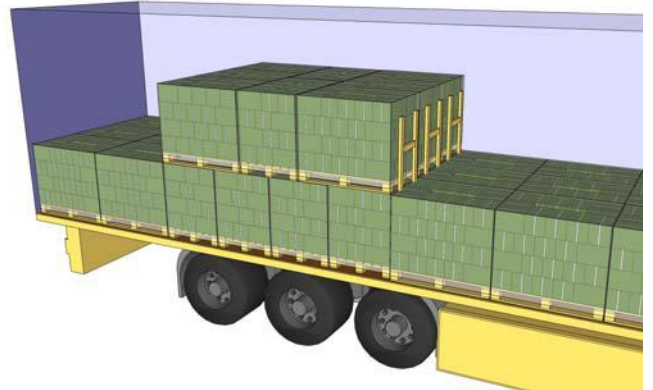

21d. Blocking by panel/fence in forward direction

3.2.5 Forward direction - multiple layers - lashing

The cargo in multiple layers may also be prevented from forward movement by lashings. In the case of lying reels with eye to the side, each reel in the front section of the second layer is to be lashed together with the two reels below with a round-turn lashing. Alternatively the reels are secured by top-over lashings. Pallets in a multiple layer may be secured by spring lashings.

Figure 22. Forward direction – multiple layers lashing

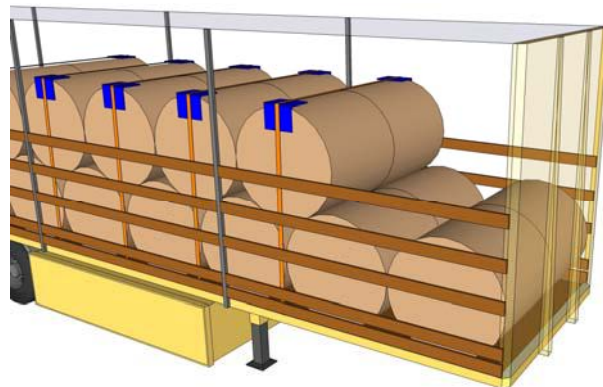

22a. Securing by top-over lashings

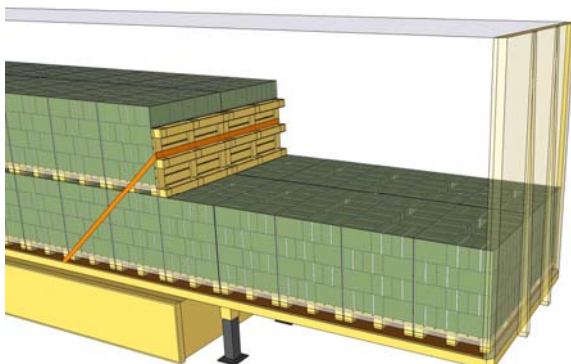

22b. Securing of a second layer by spring lashing

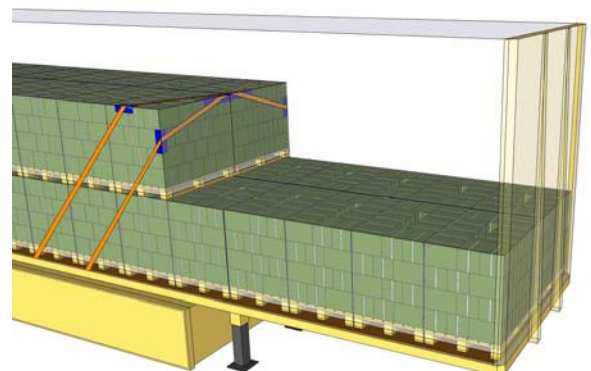

22c. Securing of a second layer by a spring lashing with two parts

3.2.6 Forward direction - multiple layers - blocking and lashing

If $H/L > 1$ (see figures below), the front section in the upper layer has to be secured to prevent forward tipping. **Note** that L in the figure is the effective length, see section 2.7.1.

Figure 23. Forward direction - multiple layers blocking and lashing

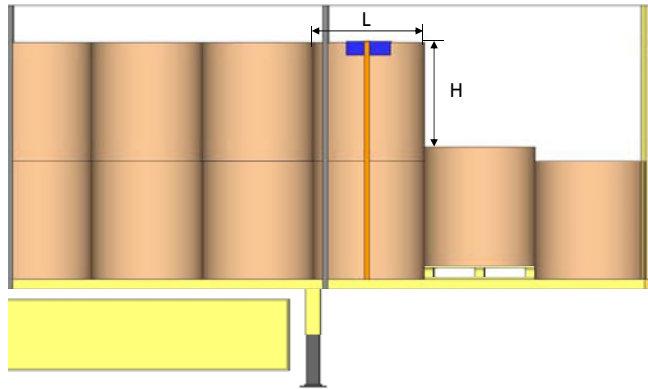

Combination of blocking and top-over lashing

3.3 Cargo securing to prevent movements in the backwards direction

The required securing arrangement to prevent movements in the backwards direction depends on the cargo weight, friction factor and the strength in the rear wall. The following alternatives are possible:

- EN 12642 code XL with strength 30 % of payload (0.3 P)
- EN 12642 code L with strength 25 % of payload (0.25 P), maximum 3100 daN
- Unmarked rear wall or cargo not blocked against the rear wall, 0 % of payload

If the cargo is blocked against a rear wall with sufficient strength and without any free space in backward direction, no additional securing is required. See the table in section 2.4.3 for possible cargo weight to be blocked against a rear wall built according to EN 12642 code L.

Note that the sketches below show cargo securing arrangements to prevent backward movements only and that blocking or lashing may be required for sideways/forward movements.

Figure 24. Cargo securing arrangements to prevent backward movements

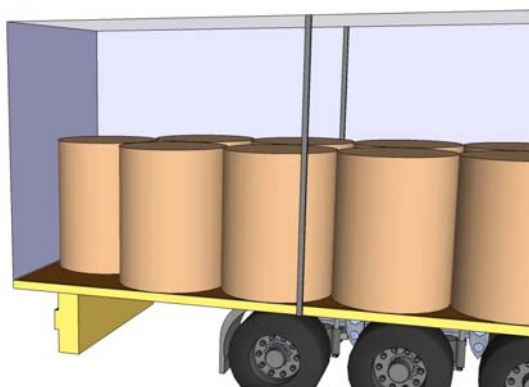

24a.

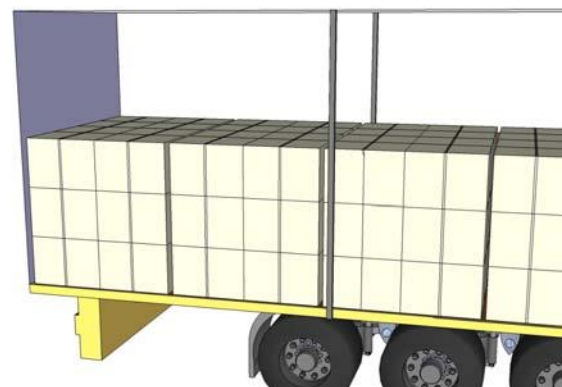

24b.

Blocking against rear wall with sufficient strength

3.3.1 Backward direction - one layer – blocking

Any free space in backward direction has to be filled out with empty pallets, dunnage bags etc.

Figure 25. Backward direction – blocking options

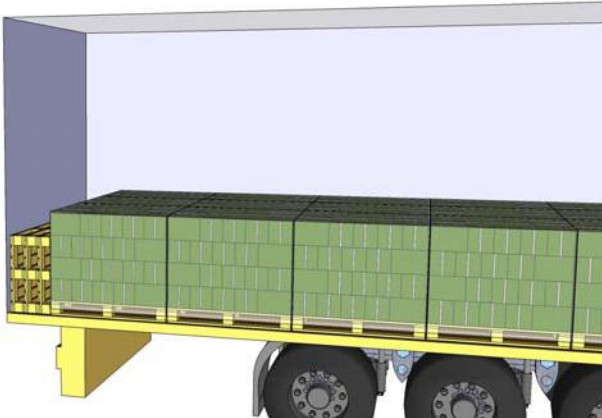

25a. Blocking by empty pallets

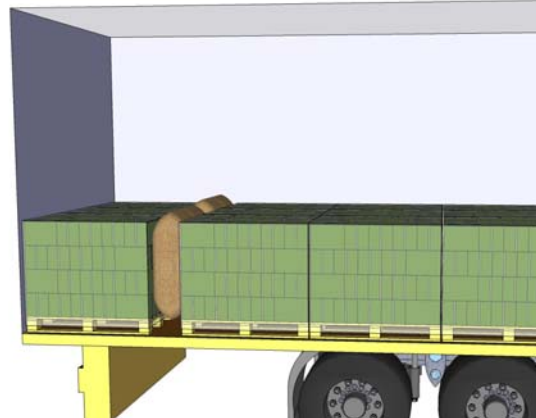

25b. Blocking by dunnage bags

The load must be secured to avoid fall out of the container when opening the door.

3.3.2 Backward direction - one layer – lashing

Figure 26. Backward direction – one layer lashing

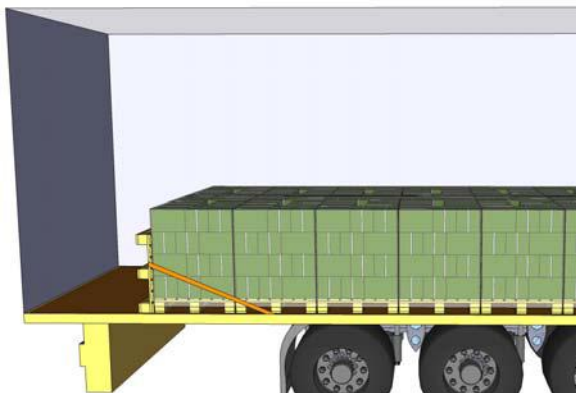

26a. Securing by spring lashing

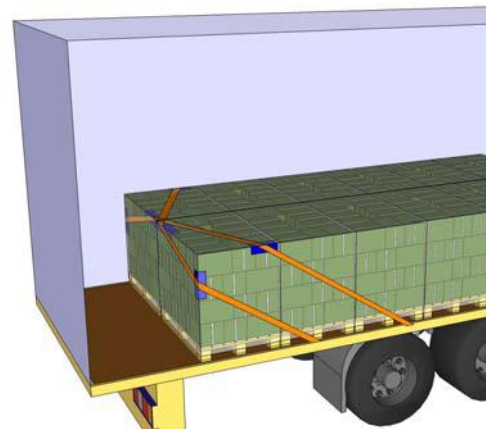

26b. Securing by spring lashing with two parts

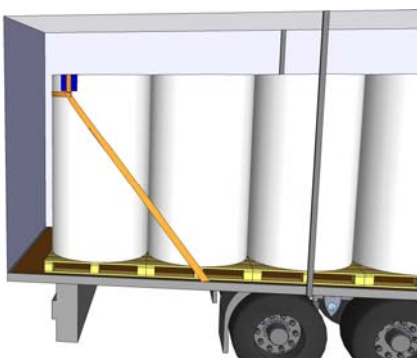

26c. Securing by spring lashing with help of a round-turn lashing

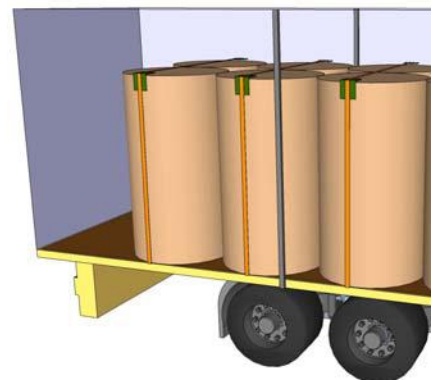
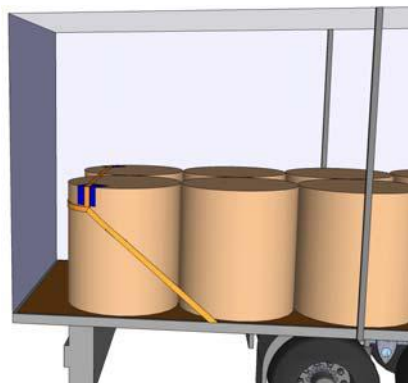

26d. Securing by top-over lashings

3.3.3 Backward direction - multiple layers – blocking

If the multiple layers are not blocked against the rear wall, the multiple layers may be bottom blocked. A threshold of minimum 50 mm made of cargo from the bottom layer/ layers with either different heights or raised by timber or pallets. Blocking may also be done by panel/fence.

Figure 27. Backward direction – multiple layers blocking

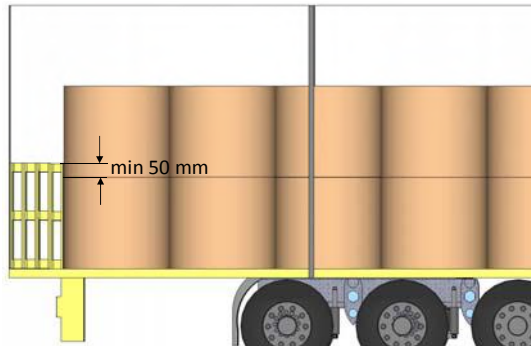

27a. Blocking by empty pallets

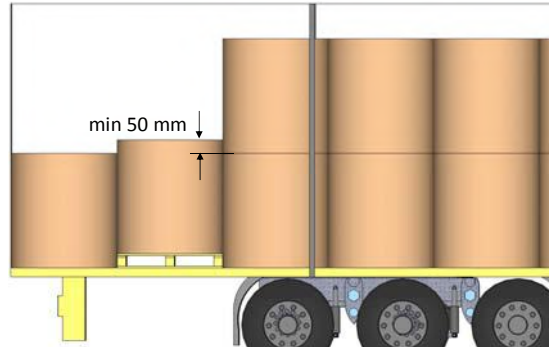

27b. Blocking of a second layer by the bottom layer raised by pallets or battens

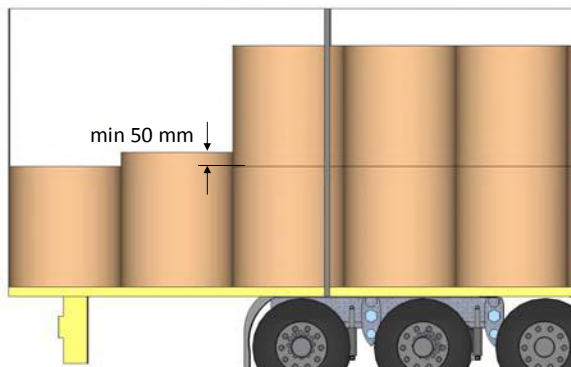

27c. Bottom blocking of a second layer by reels of different height



27d. Blocking by panel/fence

Lying reels in the rear end sections should be secured by wedges with a minimum height equal to $\frac{1}{3}$ to the radius. However, the height of the wedges does not have to exceed 200 mm if lashings are used to prevent the reel from rolling over the wedges. At least 2 wedge beds are to be placed behind each row.

Figure 28. Backward direction – rear end section blocking

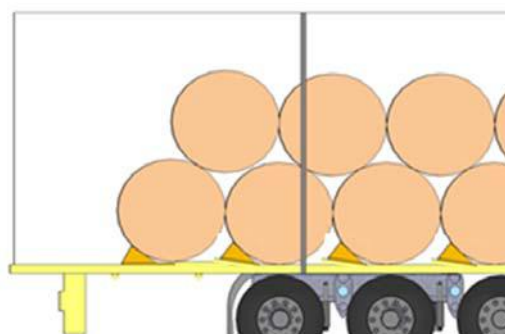

Blocking by wedge beds with a height of $\frac{\text{radius}}{3}$

3.3.4 Backward direction - multiple layers - lashing

The multiple layer/layers could alternatively be secured by lashings; spring lashings or top-over lashings, to prevent backward movements.

Figure 29. Backward direction – multiple layers lashing

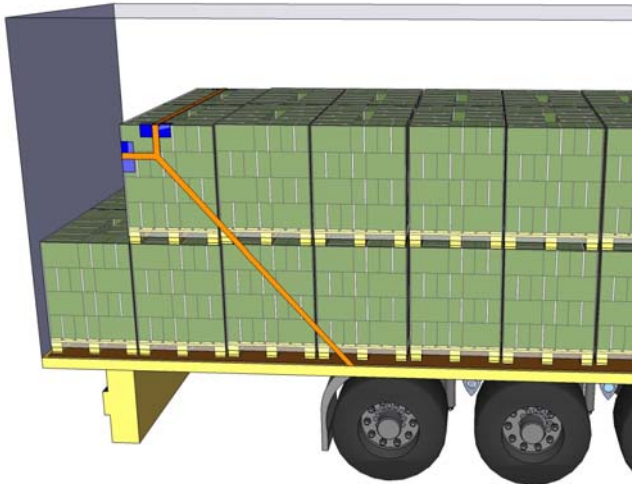

29a. Securing by spring lashing

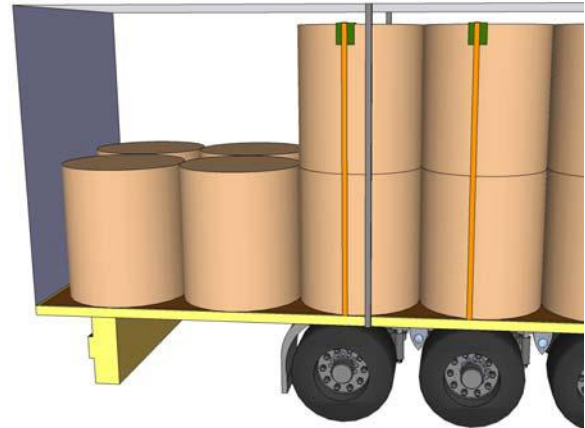

29b. Securing by top-over lashings

4. How to use the tables in the Quick Lashing Guide

The Quick Lashing Guide (according to DIN EN 12195-1) is enclosed as an Appendix to this document and is used either to design the required number of lashings for a specific cargo securing arrangement, or to decide if completed cargo securing arrangement is sufficient or not. The latter alternative is the easiest and is thus recommended. In any case, all cargo security shall be checked and verified against required securing methodology for the operating conditions of the CTU.

If lashings are used to prevent both sliding and tipping, then;

1. Calculate the number of lashings required to prevent sliding
2. Calculate the number of lashings required to prevent tipping
3. The highest number of these two values gives the minimum required number of lashings

Note the fact that the acting forces are equal for sideways and backward sliding and all unblocked cargo which are top-over lashed to prevent sideways sliding is already sufficiently secured for backward sliding.

Number of lashings: Calculate the required number of lashings by dividing the cargo weight by the actual figure found in the tables in the Quick Lashing Guide.

Conversion factor: When using cargo securing devices with other lashing capacity (LC) and pre-tension (S_{TF}) than specified in the Quick Lashing Guide the table values are to be multiplied with the conversion factors given in the Quick Lashing Guide.

Friction factor: If the combination of materials is found in the friction table or if it is measured, this value may be used provided that the surfaces are swept clean and are free from frost, ice and snow. Otherwise the friction factor (μ) = max. 0.2 shall be used for road transport and max. 0.3 for sea transport.

Cargo in multiple layer: When calculating the number of required top-over lashings for cargo stowed in more than one layer, the following steps should be followed:

1. Determine the number of lashings to prevent sliding using the weight of the entire section and the friction for the bottom layer.
2. Determine the number of lashings to prevent sliding using the weight of the section's upper layer and the friction between the layers.
3. Determine the number of lashings for the entire section which is required to prevent tipping.
4. The largest number of lashings in step 1 to 3 is to be used.

H/B and H/L: H/B for tipping sideways and H/L for tipping in forward and backward direction. **Note** that if the cargo is not rigid in form (reels, bales, etc.) the effective breadth/length is to be used in the calculations, see section 2.7.1.

Number of rows: Number of cargo rows seen from behind.

Figure 30. Number of rows – definition of H/B

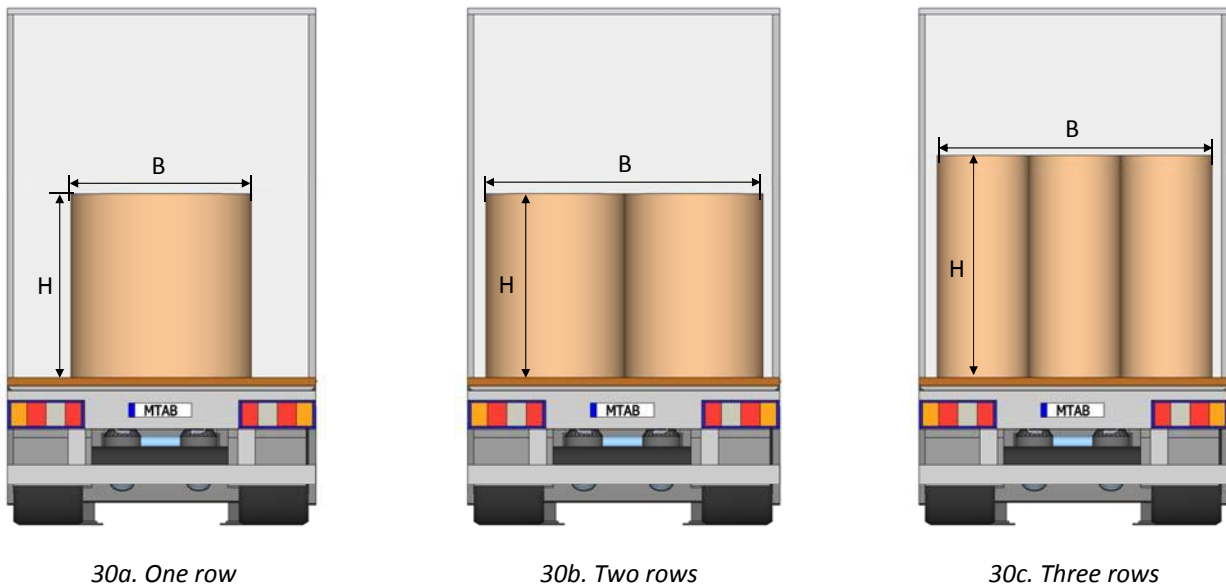

Top-over lashing: When using the tables for top-over lashings the angle α (see examples), is of great importance. The tables are valid for the angle α between $75^\circ - 90^\circ$. If the angle α is between $30^\circ - 75^\circ$ twice the number of lashings are required. If the angle α is below 30° another cargo securing method should be used.

Figure 31. Top-over lashing – angle α

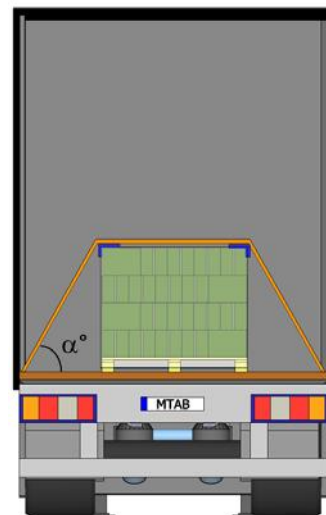

Spring lashing: It is important that the angle β between the loading platform and the lashing strap does not exceed 45° if the tables shall be valid.

The spring lashing can be done in different ways. However, if the lashing is not applied to the upper edge of the load, the tipping limits of the load weight is reduced.

For example, if the spring lashing is placed half way up the load, then it will only secure half the load weight indicated in the table from tipping.

Figure 32. Spring lashing - angle β

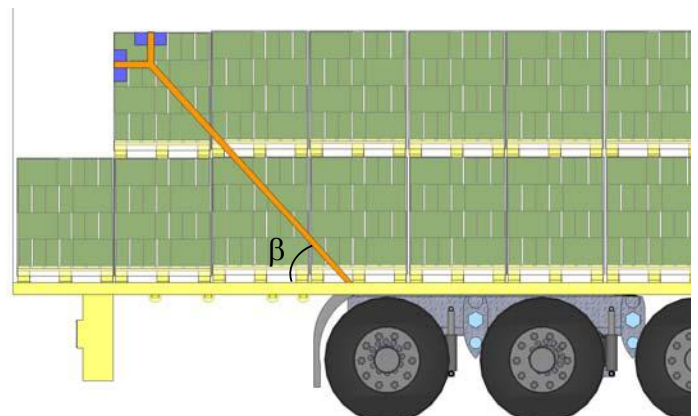

5. Other equipment for cargo securing

5.1 Edge protectors

Edge protectors are used to protect the cargo from damage caused by the lashings.

Figure 33. Edge protectors usage

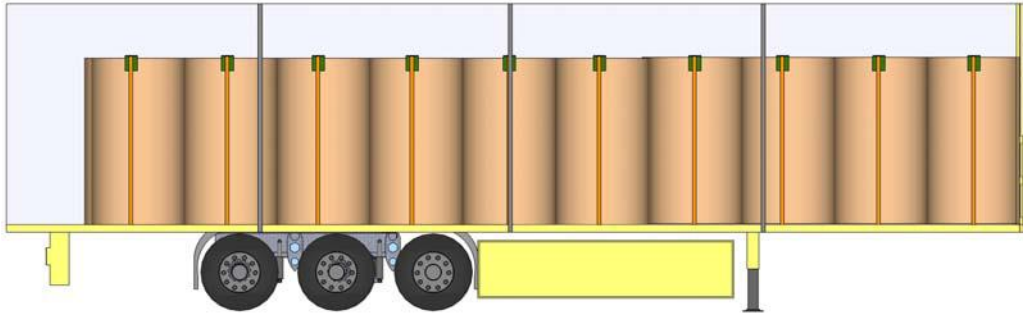

To protect the edges of paper reels from damage, corner protections with extra space should be used. Without suitable edge protectors it is impossible to lash cargo with needed forces (tension) without damaging the paper reels. Using the wrong kind of protectors will also increase the risk of damaging the reel.

Figure 34. Example of a damaged reel edge



Requirements for suitable corner protectors for paper reels

Minimum requirements:

- Internal edge (see figures 35a and 35b)
- Stiff and strong
- Stress resistant
- Temperature range -20° C to 30° C

Figure 35. Internal edge



35a.



35b.

Recommended requirements:

- Belt guide bars (see figure 37.)
- Identification marking, “branding / product name” (see figure 38.)
- One curved leg preferred
- suitability for **daily use**

Figure 36. Belt guide bars



Figure 37. Identification, marking, “branding / product name”



Figure 38. One curved leg



38a.



38b.

Not suitable protectors:

Edge protectors without internal edge are not suitable to protect the fragile reel edge

Figure 39. Internal edge missing



39a.



39b.

Cardboard protectors are not protecting reels against tension of the lashing belts.

Figure 40. Cardboard protectors



Some plastic protectors are too soft, and are not designed to withstand a lashing tension force.

Remarks:

The material is not suitable to protect reels against lashing tension.

These edge protectors have to be rejected as not suitable!

Figure 41. Soft material



41a.



41b.

5.2 Wedges

Wedges are designed in plastic or wood in a ratio of 3:4:5. Lying reels in the rear end sections should be secured by wedges with a minimum height equal to 1/3 to the reel radius, however, maximum 200 mm. Wedges are to be fixed and an example of a wedge bed is shown below.

Figure 42. Wedge description

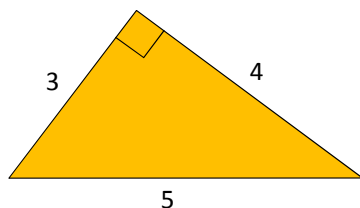

42a. Dimensions

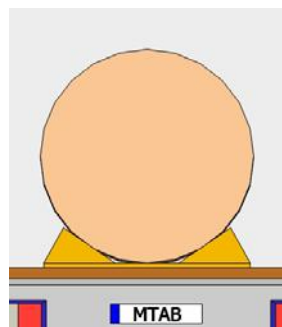

42b. Positioning

6. Example

28 standing paper reels in eleven sections and two rows are loaded and secured in different ways in different trailer types. Six of the reels are stowed in a second layer, according to the figure below.

Figure 43. Example – standing paper reels

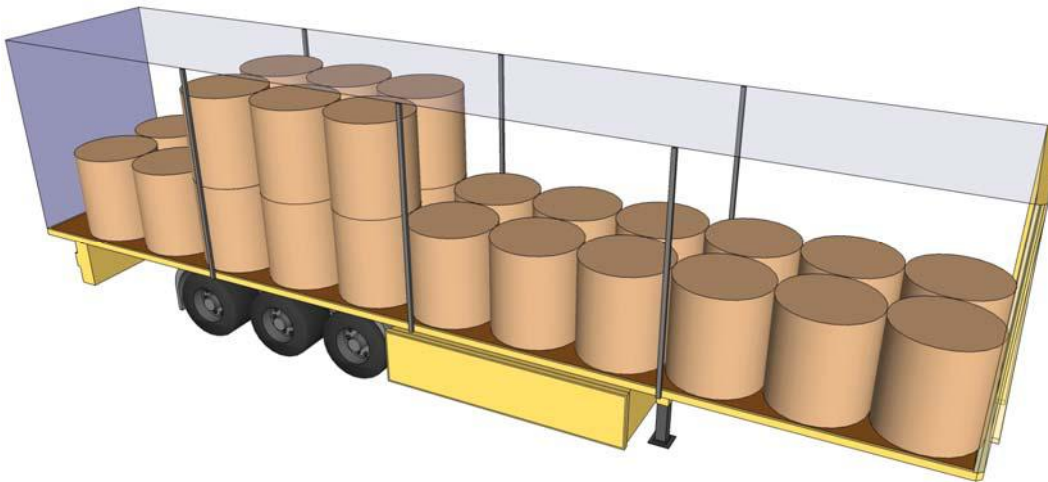

43a.

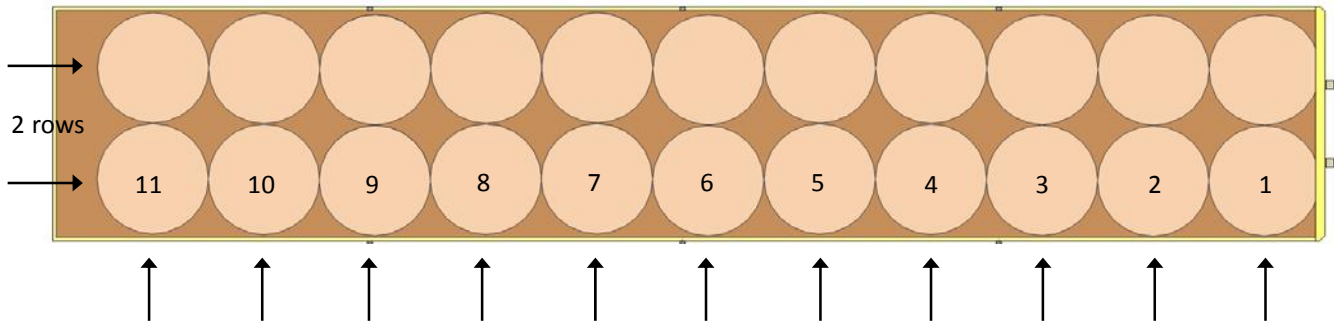

11 sections
43b.

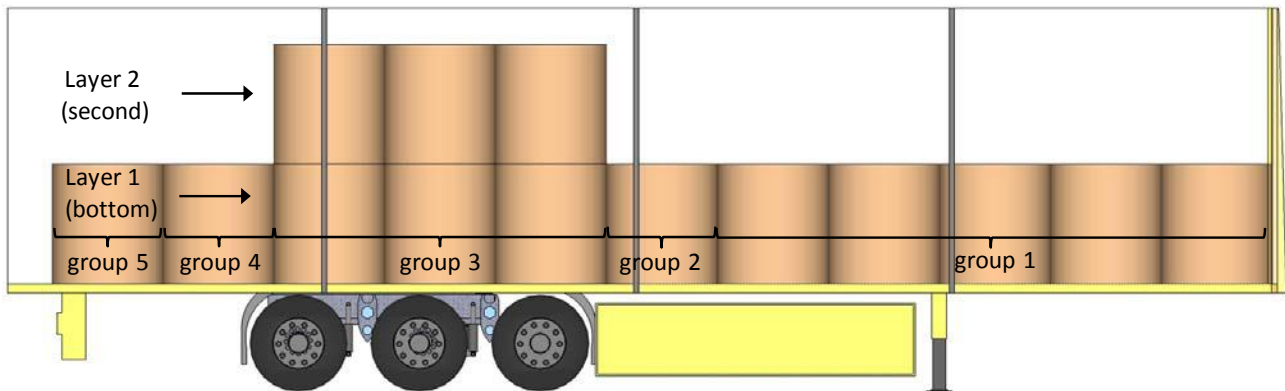

43c.

The following data is applied:

Dimensions of paper reels	Diameter \varnothing (B and L) (m)	Width W (H) (m)	Weight (kg)
		1.20	1.30

Friction factor	μ between platform/ bottom layer	μ between the layers
		0.4

Note that the diameter \varnothing is equal to the effective breadth B and length L and the width W equal to the height H in the calculations below. The assumed friction factors are an example only. If the friction factor is not measured, 0.2 should be used for paper reels as paper reels are not found in the friction table. When rubber is used, 0.6 is applied.

Lashings with lashing capacity (LC) 1600 daN and pre-tension (S_{TF}) 400 daN are used.

Decide with the help of the Quick Lashing Guide if the securing arrangements according to examples below are sufficient for transport on road when the cargo is stowed and secured in the following types of cargo transport units:

- Box trailer with strong headboard, sides and rear wall according to EN 12642 code XL.
- Curtainsider with headboard and rear wall according to EN 12642 code L and non-strong sides.
- Curtainsider with headboard and rear wall according to EN 12642 code L and non-strong sides.
Rubber is put underneath the reels and a friction factor of $\mu = 0.6$ is achieved.

A. Is the securing arrangement below in a box type trailer with headboard, side walls and rear wall with strength according to EN 12642 code XL sufficient for transport on road?

Figure 44. Box trailer with strong headboard, sides and rear wall

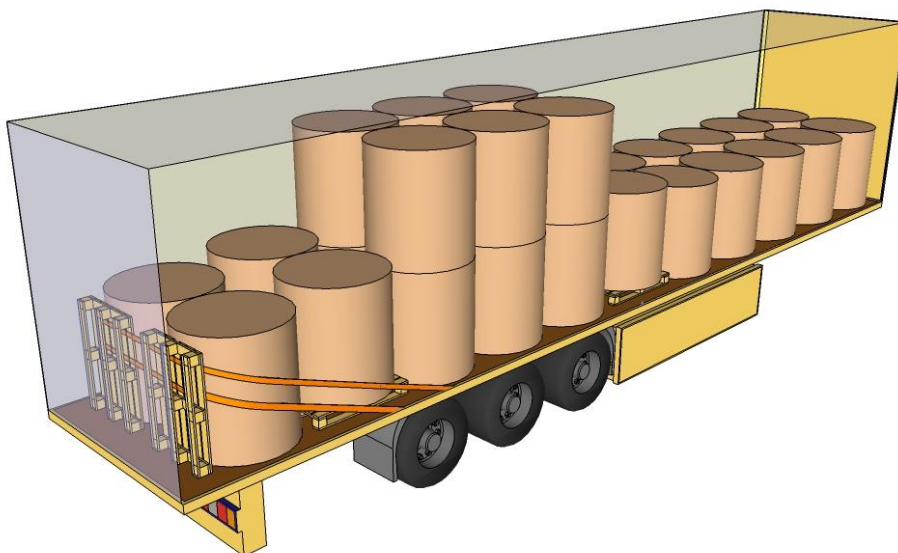

A. Cargo securing arrangement of 28 standing reels (23.8 tonnes) in partly 2 layers in a box trailer with strong headboard, side walls and rear wall with strength according to EN 12642

The reels are blocked against a strong headboard and strong side walls. The second layer is blocked forward and backward by the bottom layer where the sections in front of and behind are raised by pallets. Two spring lashings are used to prevent backward movements.

A1. Sideways with strong sides according to EN 12642 code XL

Blocking against strong side walls without any free space sideways prevents sliding and tipping sideways. No additional securing sideways is needed. It is assumed that the side walls are capable of taking up linear loads.

A2. Forward direction with strong headboard according to EN 12642 code XL

Sliding entire load: Blocking against the headboard prevents sliding and tipping in a forward direction. The strength in the headboard is 50 % of the payload (0.5 P). With a coefficient of friction of assumed 0.4 and a design acceleration of 0.8 g means that the headboard is strong enough for blocking of reels in forward direction. It is assumed that the headboard is capable of taking up linear loads.

Sliding layer 2: Blocking by the threshold made of the reels in section 6, which is raised by pallets with a height of approximate 15 cm, prevents sliding in a forward direction.

Tipping: There is no tipping risk forward; $H/L = (1.30-0.15) / 1.20 \approx 0.96 < 1.25$.

A3. Backward direction; cargo not stowed tightly to the strong rear wall

Sliding entire load: According to the Quick Lashing Guide, one spring lashing prevents 15 tonnes from sliding in backward direction (friction factor $\mu = 0.4$). 2 spring lashings prevent $2 \times 15 = 30$ tonnes from sliding backwards => 2 spring lashings are thus sufficient.

Sliding layer 2: Blocking by the threshold made of the reels in section 10, which is raised by pallets with a height of approximate 15 cm, prevents sliding in backward direction.

Tipping: There is no tipping risk backward, neither in layer 1 nor in layer 2; $H/L = 1.30/1.20 \approx 1.08 < 2$ and $H/L = (1.30-0.15) / 1.20 \approx 0.96 < 1.25$.

Thus, the cargo securing arrangement A according to the sketch above is sufficient in a box type trailer for transport on road.

B. Is the securing arrangement below in a curtainsider with headboard and rear wall with strength according to EN 12642 code L and non-strong sides sufficient for transport on road?

Figure 45. Curtainsider with headboard and rear wall

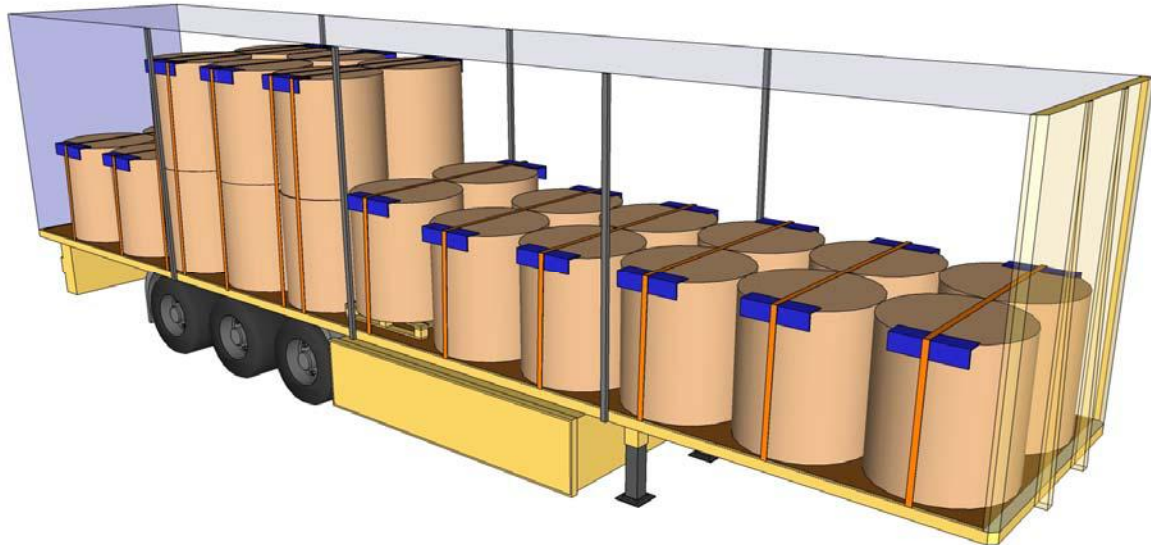

B. Cargo securing arrangement of 28 standing reels (23.8 tonnes) in partly 2 layers in a curtainsider with headboard and rear wall according to EN 12642 code L and non-strong side walls.

The reels are secured by 13 top-over lashings and corner protections according to the sketch. The second layer is blocked forward by reels in the bottom layer where the section in front of the upper layer is raised by pallets.

B1. Sideways with non-strong sides

According to the Quick Lashing Guide one top-over lashing prevents 2.9 tonnes from sliding sideways at friction factor 0.4 and 1.1 tonne cargo at friction factor 0.3.

Sliding:

Sections with one layer: cargo weight; $2 \times 0.85 = 1.7$ tonne per section; 1 top-over lashing prevents 2.9 tonnes from sliding sideways => 1 lashing per section is thus sufficient.

Sections with double layers: Bottom layer: weight of the entire section and the friction between the reels and the bottom layer; $4 \times 0.85 = 3.4$ tonnes per section; 1 top-over lashings prevent 2.9 tonnes from sliding sideways => 1 top-over lashing is thus not sufficient for the middle section.

Upper layer: weight of the section's upper layer and the friction between the layers; $2 \times 0.85 = 1.7$ tonne per section; 1 top-over lashing prevents 1.1 tonne from sliding sideways => 1 top-over lashing is thus not sufficient for the upper reels in the middle section and one extra lashing on this section is required.

Tipping:

Sections with one layer, two rows: $H/B = 1.30/2.40 \approx 0.54$ => No tipping risk.

Sections with two layers, two rows: $H/B = 2.60/2.40 \approx 1.08$, table value 1.2 to be used. According to the Quick Lashing Guide one top-over lashing prevents 4.1 tonnes from tipping. 1 top-over lashing per section is thus sufficient to prevent the sections from tipping sideways.

B2. Forward direction with a headboard with limited strength according to EN 12642 code L

Sliding entire load: Blocking against the headboard with limited strength, maximum 5 tonnes. According to the table in section 2.5.2, the headboard is able to block 12.7 tonne cargo at friction factor 0.4. The 13 top-over lashings prevent $13 \times 0.63 = 8.19$ tonnes from sliding forward. In total $12.7 + 8.19 = 20.89$ tonne cargo is thus prevented from sliding in forward direction. As the total weight is 23.8 tonnes the arrangement is thus not sufficient to prevent forward sliding.

Sliding layer 2: Blocking by the threshold made of the reels in section 6, which is raised by pallets with a height of approximate 15 cm, prevents sliding in forward direction.

Tipping: There is no tipping risk forward; $H/L = (1.30 - 0.15) / 1.20 \approx 0.96 < 1.25$.

B3. Backward direction cargo not stowed tightly to the rear wall

According to the Quick Lashing Guide one top-over lashing prevents 2.9 tonnes from sliding backward at friction factor 0.4 and 1.1 tonne cargo at friction factor 0.3.

Sliding entire load: The required 13 top-over lashings to prevent sliding sideways prevent: $13 \times 2.9 = 37.7$ tonnes from sliding backward. The 13 top-over lashings are thus sufficient to also prevent sliding backward of the 23.8 tonne reels.

Sliding layer 2: The 5 top-over lashings for the upper layer in group 3 prevent: $5 \times 1.1 = 5.5$ tonnes from sliding backward. The 5 top-over lashings are thus sufficient to also prevent sliding backward of the 5.1 tonne reels in layer 2 in group 3.

Thus, the cargo securing arrangement B according to the sketch above is not sufficient in a curtainsider with headboard and rear wall with limited strength according to EN 12642 code L and non-strong sides for transport on road.

C. An alternative to the above securing arrangement B in a curtainsider with headboard and rear wall with limited strength according to EN 12642 code L and non-strong sides are to use rubber underneath the reels. The friction factor is then at least 0.6 between the platform and the bottom layer and between the layers. Is the cargo securing arrangement below sufficient for transport on road?

Figure 46. Curtainsider with headboard and rear wall, with rubber put underneath the reels



C. Cargo securing arrangement for 28 standing reels (23.8 tonnes) with rubber underneath in partly 2 layers in a curtainsider with headboard and rear wall according to EN 12642 code L and non-strong side walls. Rubber is used underneath the reels.

The reels are secured by 11 top-over lashings.

C1. Sideways with non-strong sides

According to the Quick Lashing Guide, there is no risk of sliding at friction factor 0.6. The risk of wandering should be taken into consideration.

Sliding entire load: No risk of sliding. Consideration of the wandering risk has been taken by at least one lashing per 4 tonne cargo weight.

Sliding layer 2: No risk of sliding. Consideration of the wandering risk has been taken by at least one lashing per 4 tonne cargo weight.

Tipping:

Sections with one layer, two rows: $H/B = 1.30/2.40 \approx 0.54 \Rightarrow$ No tipping risk.

Sections with two layers, two rows: $H/B = 2.60/2.40 \approx 1.08$. For the nearest higher table value 1.2, one top-over lashing prevents 4.1 tonnes of cargo from tipping sideways. The 3 lashings thus prevent $3 \times 4.1 = 12.3$ tonne cargo from tipping sideways \Rightarrow 3 lashings are thus sufficient to prevent the 10.2 tonnes of cargo in group 3 from tipping.

C2. Forward direction with a headboard with limited strength according to EN 12642 code L

Sliding entire load: Blocking against the headboard with limited strength, maximum 5 tonnes. According to the table in section 2.4.2 the headboard is able to block 25.0 tonne cargo at friction factor 0.6. With the cargo weight of 23.8 tonnes the headboard is strong enough to block the entire cargo weight and no lashings are required in complement. It is assumed that the headboard is capable of taking up linear loads.

Sliding layer 2: According to the Quick Lashing Guide, one top-over lashing prevents 1.9 tonne of cargo from sliding in forward direction at friction factor 0.6. 3 top-over lashings thus prevent $3 \times 1.9 = 5.7$ tonnes, which is sufficient to prevent the 5.1 tonne cargo in the upper layer from sliding forward.

Tipping: There is no tipping risk forward; $H/L = 1.30/1.20 \approx 1.08 < 1.25$.

C3. Backward direction cargo not stowed tightly to the rear wall

According to the Quick Lashing Guide there is no risk of sliding backward at friction factor 0.6. Consideration to the risk of wandering should be taken.

Sliding entire load: No risk of sliding. Consideration of the wandering risk has been taken by at least one lashing per 4 tonne cargo weight.

Sliding layer 2: No risk of sliding. Consideration of the wandering risk has been taken by at least one lashing per 4 tonne cargo weight.

Tipping: There is no tipping risk backward: $H/L = 1.30/1.20 \approx 1.08 < 2 \Rightarrow$ No tipping risk.

Thus, the cargo securing arrangement C according to the sketch above is sufficient in a curtainsider with headboard and rear wall with limited strength according to EN 12642 code L and non-strong sides for transport on road if rubber is used underneath the reels.

These guidelines were produced in co-operation between:

CEPI – Confederation of European Paper Industries
Avenue Louise 250, P.O. Box 80, B-1050 Brussels, Belgium
Tel. +32 2 627 49 22, Fax. +32 2 646 81 37
b.lombard@cepi.org, www.cepi.org, www.paperonline.org

MariTerm AB

P.O Box 74, SE 263 21 Höganäs, Sweden
Tel. +46 42 33 31 00, Fax. +46 42 33 31 02
info@mariterm.se, www.mariterm.se

Thank you to the CEPI Transportation Network and the company experts for their full support and contribution to these guidelines.

Annex I – Abbreviations and Acronyms

- CEN: European Committee for Standardization
- CEPI: Confederation of European Paper Industries
- CTU: Cargo Transport Unit
- daN: dekaNewton
- H/B/L= Height/Breadth/Length
- LC: Lashing Capacity
- STF: pre-tension force

Annex II – List of Figures

	Page
• Figure 1. Acceleration forces.....	4
• Figure 2. Typical content of webbing strap label, marked in accordance with EN 12195-2.....	5
• Figure 3. Strength requirements of CTU side wall, headboard and rear wall.....	6
• Figure 4. Load weight prevented from sliding by a L headboard as function of the friction factor....	7
• Figure 5. Load weight prevented from sliding by a L- rear wall as function of the friction.....	8
• Figure 6. Material combination in contact surface and friction factor.....	9
• Figure 7. Practical inclination tests for determination of the friction.....	10
• Figure 8. Positioning of anti-slip material for standing reel to apply friction in- forward and backward direction (seen from the top).....	10
• Figure 9. Load in “zig-zag” positioning with the proper lashing option.....	11
• Figure 10. Definition of H/B/L of the cargo unit for tipping.....	12
• Figure 11. Practical inclination test.....	12
• Figure 12. Blocking against sidewalls.....	13
• Figure 13. Sideways lashing.....	14
• Figure 14. Sideways blocking and lashing.....	14
• Figure 15. Securing of lying large reels with eye forward.....	15
• Figure 16. Blocking against headboard.....	16
• Figure 17. Forward direction - blocking.....	16
• Figure 18. Forward direction - stowage.....	17
• Figure 19. Forward direction – one layer lashing.....	17
• Figure 20. Forward direction – combination of blocking and lashing.....	18
• Figure 21. Forward direction – multiple layers blocking.....	18
• Figure 22. Forward direction – multiple layers lashing.....	19
• Figure 23. Forward direction - multiple layers blocking and lashing.....	20
• Figure 24. Cargo securing arrangements to prevent backward movements.....	20
• Figure 25. Backward direction – blocking options.....	21
• Figure 26. Backward direction – one layer lashing.....	21
• Figure 27. Backward direction – multiple layers blocking.....	22
• Figure 28. Backward direction – rear end section blocking.....	22
• Figure 29. Backward direction – multiple layers lashing.....	23
• Figure 30. Number of rows – definition of H/ B.....	25
• Figure 31. Top-over lashing – angle α	25
• Figure 32. Spring lashing - angle β	25
• Figure 33. Edge protector usage.....	26
• Figure 34. Example of a damaged reel edge.....	26
• Figure 35. Internal edge.....	26
• Figure 36. Belt guide bars.....	27
• Figure 37. Identification marking, “branding / product name”	27
• Figure 38. One curved leg.....	27
• Figure 39. Internal edge missing.....	27
• Figure 40. Cardboard protectors.....	28
• Figure 41. Soft material.....	28
• Figure 42. Wedge description.....	28

- Figure 43. Example – standing paper reels..... 29
- Figure 44. A. Box trailer with strong headboard, sides and rear wall..... 30
- Figure 45. B. Curtainsider with headboard and rear wall..... 32
- Figure 46. C. Curtainsider with headboard and rear wall, with rubber put underneath the reels..... 34

Annex III - Quick Lashing Guide: Safe Load Securing for Road Transport – In accordance with EN 12195-1:2010

This guide offers practical instructions for securing all kinds of loads - not specifically pulp and paper - in accordance with the European standard EN 12195-1:2010.

It can be a reference for all public or private parties directly or indirectly concerned by cargo securing. This document should be read and used as a help for the application of safe and tried practices in this area.

It is not binding in the sense of a legal act adopted at EU or national level.

Quick lashing guide

on safe load securing for road transport

**In accordance with
EN 12195-1:2010**



LC 1600

This guide offers
practical instructions for securing loads
in accordance with the European standard
EN 12195-1:2010.

*All values in the tables are expressed as
a round number of 2 digits.*

*In the tables on pages 12-19 'no risk' means that
there is no risk of the load sliding or tipping.*

© TYA, 2014

Art no: 52 360-H

Edition: 4:1, 2014

Facts: TYA, MariTerm AB

Production: Bildinformation i Älvsjö AB

Conditions for securing with this guide

The load must be prevented from sliding and tipping when exposed to forces occurring during transport.

The securing of load must be done using locking, blocking, lashing or a combination of these techniques.

Lashing equipment

Values in this guide have been calculated on the assumption that the;

... *lashing points* resist 2 tonnes under stress



... *webbings* have a Lashing Capacity (LC) of 1600 daN (1.6 tonnes under stress)

... *webbings* with $S_{TF} = 400$ daN (tightened to 400 kg).



The straps must be tightened to a minimum of 400 kg throughout the transport.

The best option for load securing...

Where possible blocking should be used as a method to secure the load

Blocking involves positioning the load, or parts of the load directly to the headboard, sideboards, stanchions, supports, walls or parts of the load to stop it from moving.

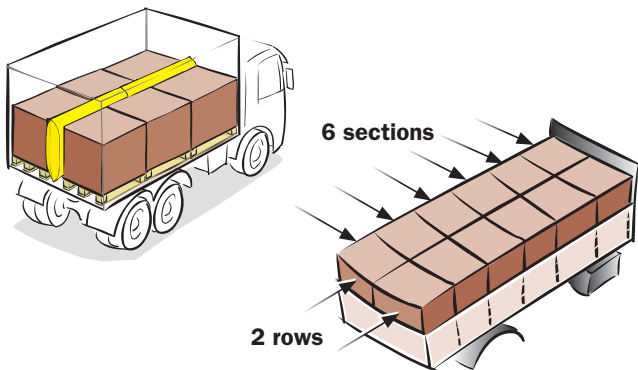

If the load is blocked to a sufficient height, this will effectively stop it from sliding and tipping.

If the load is only bottom blocked, lashing may be needed to prevent tipping.

See the tipping tables on pages 13-19.

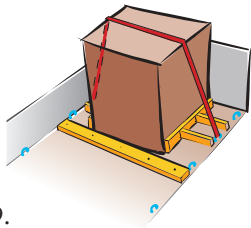

Headboard and rear wall

Headboards and rear walls on vehicles with a payload over 12.5 tonnes built in accordance with EN 12642 L.

Headbord - EN 12642 L

Friction factor, μ	Load weight (in tonnes) possible to block against the headboard in forward direction
0,15	7,8
0,20	8,4
0,25	9,2
0,30	10,1
0,35	11,3
0,40	12,7
0,45	14,5
0,50	16,9
0,55	20,3
0,60	25,4

If the weight of the load is greater than that shown in the tables, then in addition to blocking, lashing will be required.

Rear wall - EN 12642 L

Friction factor, μ	Load weight (in tonnes) possible to block against the rear wall towards the rear
0,15	9,0
0,20	10,5
0,25	12,6
0,30	15,8
0,35	21,0
0,40	31,6

4 inch (4") nail



These values are taken from the IMO Model Course 3.18 and recalculated in accordance with EN 12195-1: 2010.

Load weight in tonnes where one nail will stop sliding movement

μ	Sideways		Forwards		Towards the rear	
	each side, 4" nail		4" nail		4" nail	
	Plain	Galv-nised	Plain	Galv-nised	Plain	Galv-nised
0,2	0,36	0,53	0,18	0,26	0,36	0,53
0,3	0,55	0,80	0,22	0,32	0,55	0,80
0,4	1,1	1,6	0,27	0,40	1,1	1,6
0,5	<i>no risk</i>	<i>no risk</i>	0,36	0,53	<i>no risk</i>	<i>no risk</i>
0,6	<i>no risk</i>	<i>no risk</i>	0,55	0,80	<i>no risk</i>	<i>no risk</i>
0,7	<i>no risk</i>	<i>no risk</i>	1,1	1,6	<i>no risk</i>	<i>no risk</i>

Unlashed loads and the risk of movement

If there is no risk of a load sliding or tipping (as shown in the tables of this guide) the load can be transported without the use of lashing straps.

If there is a risk that an unlashed load will move in transit because of vibration and the load is not blocked appropriately, then it must be secured using an alternative means.



Other ways to secure a load

Loads can also be secured by using friction or lashing methods.

Calculation for lashing requirements

If lashing are used to stop the load from moving, then;

1. Calculate the number of lashing straps needed to prevent a sliding movement.
2. Calculate the number of lashing straps needed to prevent the loads from tipping.
3. The highest number of these two values shows the minimum number of lashing straps needed.

Supporting edge profil

In some cases, less lashing straps than the number of sections of the load can be used. Each section of the load must be secured.

A ‘supporting edge profile’ may be used to spread the effects of each lashing. These profiles may be constructed of wooden planks (at least 25mm x 100mm). Other material with the same strength values can also be used, such as aluminium or similar material.

At least one lashing strap should be used, for every 2nd section of the load, with one at each end.

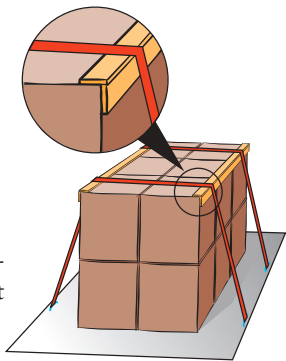

Sliding

The friction between the load and the loading platform (or load beneath it) has a huge influence on how much one lashing can hold.

The table below gives the typical friction factors for common combinations of materials contacting each other or the vehicle load platforms.

The values in the table are valid only when the contact surfaces are clean, undamaged and without frost, ice or snow.

If this is not the case, then a friction factor (μ) = 0,2 must be used. Special precautions shall be taken if the surfaces are oiled or greasy.

The values in this table are for both dry and wet surfaces.

Combination of materials in the contact surface	Friction factor, μ
--	--

Sawn wood	
------------------	--

Sawn wood – fabric base laminate/plywood	0,45
--	------

Sawn wood – grooved aluminium	0,40
-------------------------------------	------

Sawn wood – shrink film	0,30
-------------------------------	------

Sawn wood – stainless steel sheet	0,30
---	------

**Combination of materials
in the contact surface****Friction
factor, μ** **Plane wood**

Plane wood – fabric base laminate/plywood0,30

Plane wood – grooved aluminium0,25

Plane wood – stainless steel sheet0,20

Plastic pallet

Plastic pallet – fabric base laminate/plywood0,20

Plastic pallet – grooved aluminium0,15

Plastic pallet – stainless steel sheet0,15

Steel and metal

Steel crate – fabric base laminate/plywood0,45

Steel crate – grooved aluminium0,30

Steel crate – stainless steel sheet0,20

Concrete

Concrete rough – sawn wood battens0,70

Concrete smooth – sawn wood battens0,55

Anti-slip material

Rubber0,60

Other material According to certificate

Tipping

To find out the maximum load weight prevented from tipping, refer to the tables on pages 13-19 in this guide. The H/B (height divided by the breadth) or H/L (height divided by the length) of load to be secured must be calculated.

The calculations must be rounded up to the nearest higher value shown in the tables.

Load items with the centre of gravity close to their centre

The following sketches explain how to measure the H(height), L(length) and B(breadth) of the load.

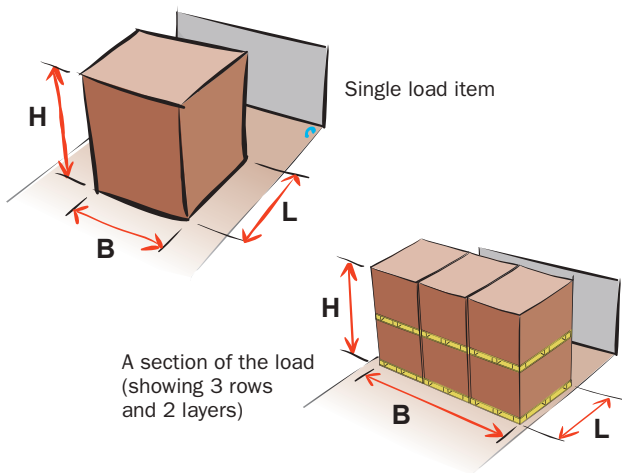

Load items with displaced centre of gravity

If the load item to be secured has a centre of gravity above its centre or out to the side, then the H, B and L measurements should be done as shown in the diagram below.

H = *Distance up to the centre of gravity*

B = *Shortest distance between the centre of gravity and the sideways tipping point*

L = *Distance according to the diagram*

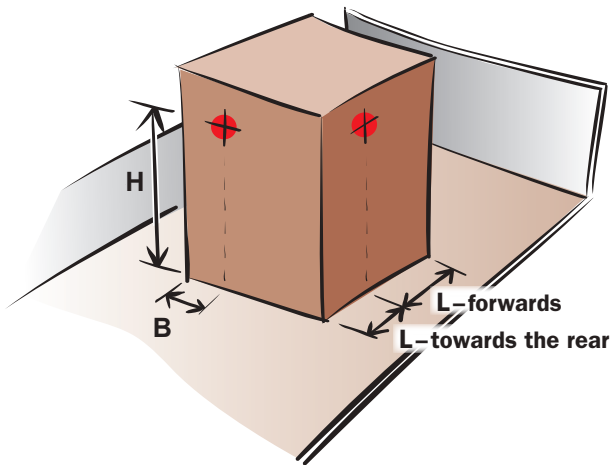

Top-over lashing

Using the table below, you must note that the angle between the lashing and the loading platform is of great importance. The tables should be used for angles between 75° and 90° . If the angle is between 30° and 75° double amount of lashing straps are needed, or you halve the table values.

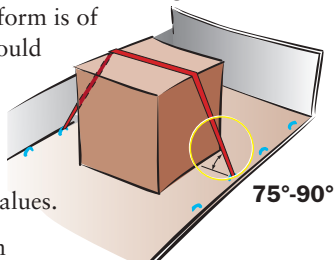

If the angle is less than 30° , then another method of securing the load must be used.

Goods weight in tonnes where one top-over lashing strap will stop sliding movements

μ	Sideways	Forwards	Towards the rear
0,15	0,31	0,15	0,31
0,20	0,48	0,21	0,48
0,25	0,72	0,29	0,72
0,30	1,1	0,38	1,1
0,35	1,7	0,49	1,7
0,40	2,9	0,63	2,9
0,45	6,4	0,81	6,4
0,50	<i>no risk</i>	1,1	<i>no risk</i>
0,55	<i>no risk</i>	1,4	<i>no risk</i>
0,60	<i>no risk</i>	1,9	<i>no risk</i>
0,65	<i>no risk</i>	2,7	<i>no risk</i>
0,70	<i>no risk</i>	4,4	<i>no risk</i>

Load weight in tonnes where one top-over lashing strap will stop **tipping motion**

H/B	Sideways					H/L	For-wards	Towards the rear
	1 row	2 rows	3 rows	4 rows	5 rows			
0,6	<i>no risk</i>	<i>no risk</i>	<i>no risk</i>	5,8	2,9	0,6	<i>no risk</i>	<i>no risk</i>
0,8	<i>no risk</i>	<i>no risk</i>	4,9	2,1	1,5	0,8	<i>no risk</i>	<i>no risk</i>
1,0	<i>no risk</i>	<i>no risk</i>	2,2	1,3	0,97	1,0	<i>no risk</i>	<i>no risk</i>
1,2	<i>no risk</i>	4,1	1,4	0,91	0,73	1,2	<i>no risk</i>	<i>no risk</i>
1,4	<i>no risk</i>	2,3	0,99	0,71	0,58	1,4	5,3	<i>no risk</i>
1,6	<i>no risk</i>	1,5	0,78	0,58	0,49	1,6	2,3	<i>no risk</i>
1,8	<i>no risk</i>	1,1	0,64	0,49	0,42	1,8	1,4	<i>no risk</i>
2,0	<i>no risk</i>	0,90	0,54	0,42	0,36	2,0	1,1	<i>no risk</i>
2,2	4,5	0,75	0,47	0,37	0,32	2,2	0,83	7,2
2,4	3,3	0,64	0,42	0,33	0,29	2,4	0,68	3,6
2,6	2,4	0,56	0,37	0,30	0,26	2,6	0,58	2,4
2,8	1,8	0,50	0,34	0,28	0,24	2,8	0,51	1,8
3,0	1,4	0,45	0,31	0,25	0,22	3,0	0,45	1,4
3,2	1,2	0,41	0,29	0,24	0,21	3,2	0,40	1,2

If you need more than one lashing strap for each section of the load, then tensioning devices should be placed alternately on both sides.

The calculation values for movement forwards and towards the rear assume that lashing straps are spread equally on each section of the load.

Loop lashing

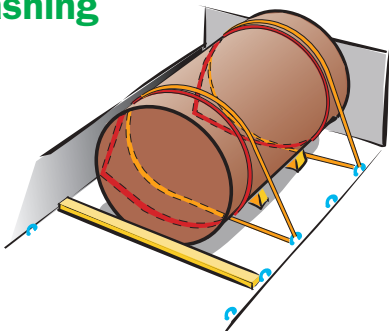

A loop lashing will secure a load item on each side with a pair of webbings. At the same time the load will be prevented from tipping. At least two loop lashings per load item should be used.

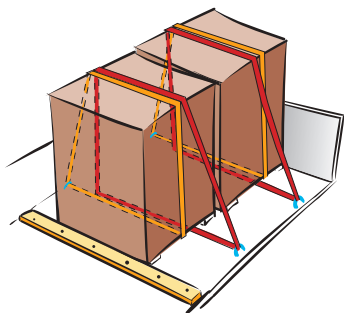

If the load item contains more than one section and the sections support each other and stop any twisting from occurring, then only one loop lashing per section of the load, may be needed.

The values in these tables will apply only when each end of the loop lashing strap is fastened at different lashing points.

If both ends of a loop lashing are fastened to the same lashing point, then this point must hold 1.4 x lashing LC.

Load weight in tonnes where one loop lashing will stop **sliding movement**

μ	Sideways	μ	Sideways
0,15	4,7	0,45	13
0,20	5,4	0,50	<i>no risk</i>
0,25	6,2	0,55	<i>no risk</i>
0,30	7,3	0,60	<i>no risk</i>
0,35	8,7	0,65	<i>no risk</i>
0,40	11	0,70	<i>no risk</i>

Load weight in tonnes where one loop lashing will stop **tipping motion**

Sideways					
H/B	1 row	2 rows	3 rows	4 rows	5 rows
0,6	<i>no risk</i>	<i>no risk</i>	<i>no risk</i>	6,5	4,1
0,8	<i>no risk</i>	<i>no risk</i>	5,6	3,1	2,3
1,0	<i>no risk</i>	<i>no risk</i>	3,1	2,0	1,6
1,2	<i>no risk</i>	4,6	2,1	1,5	1,3
1,4	<i>no risk</i>	3,0	1,6	1,2	1,0
1,6	<i>no risk</i>	2,2	1,3	1,0	0,86
1,8	<i>no risk</i>	1,8	1,1	0,86	0,74
2,0	<i>no risk</i>	1,5	0,94	0,75	0,65
2,2	5,1	1,2	0,83	0,67	0,58
2,4	3,7	1,1	0,74	0,60	0,53
2,6	2,9	0,96	0,66	0,54	0,48
2,8	2,4	0,86	0,61	0,50	0,44
3,0	2,0	0,78	0,56	0,46	0,41
3,2	1,8	0,72	0,51	0,43	0,38

Spring lashing

A spring lashing is used to stop movement of a load item forwards and/or towards the rear. It is important that the angle between the loading platform and the lashing strap does not exceed 45° .

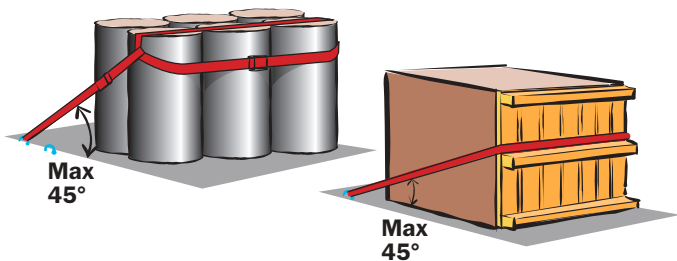

The spring lashing can be done in many ways. However, if the lashing is not applied to the upper edge of the load item, the tipping limits of the load weight is reduced.

For example, if the spring lashing is placed half way up the load item, then it will only secure half the load weight indicated in the table.

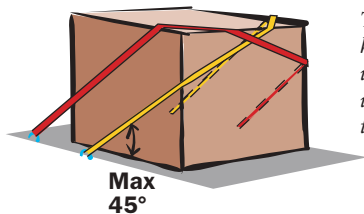

This spring lashing set-up has two legs on each side, which secures twice the weight that is indicated in the table.

Load weight in tonnes where one spring lashing will stop **sliding movement**

μ	Forwards	Towards the rear	μ	Forwards	Towards the rear
0,15	3,7	6,6	0,45	6,7	19
0,20	4,1	7,6	0,50	7,5	<i>no risk</i>
0,25	4,5	8,8	0,55	8,4	<i>no risk</i>
0,30	4,9	10	0,60	9,6	<i>no risk</i>
0,35	5,4	12	0,65	11	<i>no risk</i>
0,40	6,0	15	0,70	13	<i>no risk</i>

Load weight in tonnes where one spring lashing will stop **tiping motion**

H/L	Forwards	Towards the rear
1,2	<i>no risk</i>	<i>no risk</i>
1,4	54	<i>no risk</i>
1,6	26	<i>no risk</i>
1,8	19	<i>no risk</i>
2,0	15	<i>no risk</i>
2,2	13	101
2,4	12	55
2,6	11	40
2,8	10	32
3,0	9,9	28
3,2	9,5	25

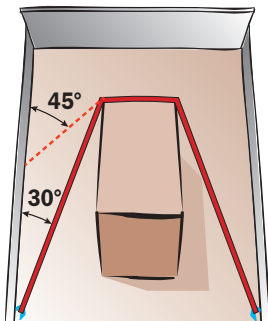

If the angle sideways exceeds 5° the table values must be reduced with:

Angle 5°-30° → 15%

Angle 30°-45° → 30%

Direct lashing

Lashings must be fixed within the green angles, as shown in the diagram. This will ensure that they secure the individual load item in accordance with the table values.

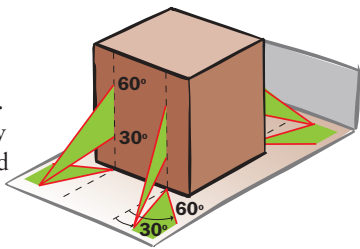

Left and right lashings

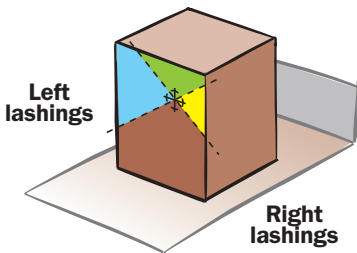

The areas where you can attach lashing straps are limited by two straight lines running diagonally through the centre of gravity at an angle of 45°.

Load weight in tonnes where one direct lashing strap will stop **sliding movement**

μ	Sideways	Forwards	Towards the rear	μ	Sideways	Forwards	Towards the rear
0,15	1,5	0,82	1,5	0,45	5,4	1,9	5,4
0,20	1,8	0,95	1,8	0,50	<i>no risk</i>	2,2	<i>no risk</i>
0,25	2,2	1,1	2,2	0,55	<i>no risk</i>	2,6	<i>no risk</i>
0,30	2,6	1,3	2,6	0,60	<i>no risk</i>	3,0	<i>no risk</i>
0,35	3,3	1,4	3,3	0,65	<i>no risk</i>	3,5	<i>no risk</i>
0,40	4,2	1,7	4,2	0,70	<i>no risk</i>	4,2	<i>no risk</i>

Load weight in tonnes where one direct lashing strap will stop **tipping motion**

H/B	Sideways	H/L	Forwards	Towards the rear
1,2	<i>no risk</i>	1,2	<i>no risk</i>	<i>no risk</i>
1,4	<i>no risk</i>	1,4	8,2	<i>no risk</i>
1,6	<i>no risk</i>	1,6	3,8	<i>no risk</i>
1,8	<i>no risk</i>	1,8	2,6	<i>no risk</i>
2,0	<i>no risk</i>	2,0	2,0	<i>no risk</i>
2,2	4,1	2,2	1,7	13,0
2,4	3,2	2,4	1,5	6,9
2,6	2,6	2,6	1,4	4,9
2,8	2,3	2,8	1,2	3,9
3,0	2,0	3,0	1,2	3,3
3,2	1,9	3,2	1,1	2,9

Other lashing equipment

Values for LC and S_{TF} are marked on the lashing equipment.

If the LC for a chain is not known, the LC can be set to 50% of the breaking load.



Recalculating

If equipment with a different capacity to LC1600 or S_{TF} 400 are used, the figures in the sliding and tipping tables have to be multiplied with the following factors.

When recalculating, never use larger LC or S_{TF} than the lashing points can hold.

Methods

Top-over lashing

For sliding:

$$\frac{\text{Actual } S_{TF}}{400} = \text{Multiplication factor}$$

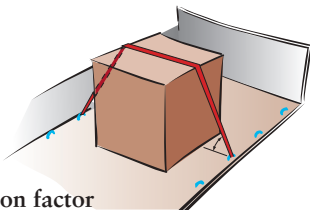

For tipping the smallest of the following factors shall be used:

$$\frac{\text{Actual } S_{TF}}{400} \quad \text{or} \quad \frac{\text{Actual LC}}{1600} = \text{Multiplication factor}$$

Loop lashing

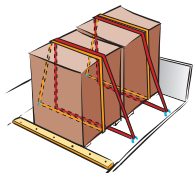

$$\frac{\text{Actual LC}}{1600} = \text{Multiplication factor}$$

Spring lashing



$$\frac{\text{Actual LC}}{1600} = \text{Multiplication factor}$$

Direct lashing

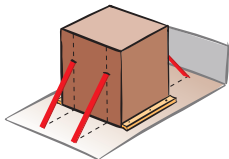

$$\frac{\text{Actual LC}}{1600} = \text{Multiplication factor}$$

Loads consisting of several layers

Determination of the number of top-over lashing straps needed to secure loads items stowed in several layers when they are not blocked sideways.

Using the following four steps

1. Calculate the number of lashing straps needed to secure the weight of the whole section from sliding using friction in the bottom.
2. Calculate the number of lashing straps needed to secure the weight of the upper section from sliding, using friction between the upper and lower layer.
3. Calculate the number of lashing straps needed to stop tipping of the whole section.
4. The highest number of lashings from the three calculations should be used.

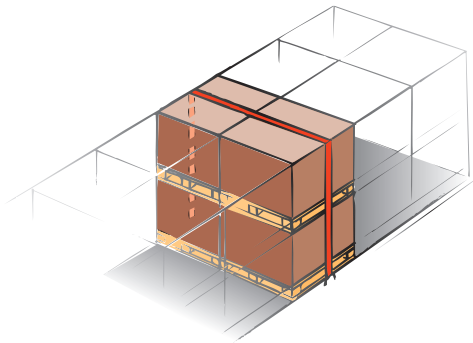

The load securing arrangement must carry...

... 0,8 of the cargo weight forwards

... 0,5 of the cargo weight sideways and towards the rear

... 0,6 of the cargo weight sideways if there is risk of the load tipping

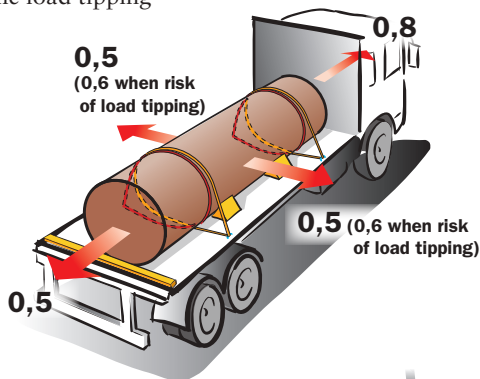

Rolling goods

You must prevent rolling goods from moving by using wedges or similar restraints.

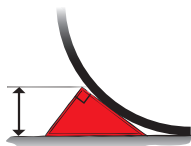

Non-rigid goods

If the goods are not rigid, then more load restraints will need to be used than is shown in this guide.





The Vocational Training and Working Environment Council

TYA | Box 1826, 171 26 Solna, Sweden
Telephone +46 87 34 52 00 | Fax +46 87 34 52 02
e-mail: info@tya.se | www.tya.se

