



Llywodraeth Cymru
Welsh Government

Policy and Strategy

Active Travel Act Guidance

July 2021

Contents

Foreword	9
Vision and priorities	11
Part 1: Delivery of active travel in Wales	13
Chapter 1: Introduction	14
1.1 Active travel in Wales	14
1.2 The act and this guidance	15
1.3 Definition of an active traveller within the act – walkers, cyclists and other highway users	18
1.4 Other definitions	19
Chapter 2: The duties on local authorities and Welsh Ministers	21
2.1 The duties under the Active Travel (Wales) Act 2013	21
2.2 Duties for provision for walkers and cyclists when changes are made to the highway	25
2.3 Review of the act	26
Chapter 3: Policy and legislative context	27
3.1 Introduction	27
3.2 Well-being of Future Generations (Wales) Act 2015	27
3.3 Llwybr Newydd – A New Wales Transport Strategy	29
3.4 Equality Act (2010)	31
3.5 Planning Policy Wales	33
3.6 Future Wales – the national plan 2040	34
3.7 WelTAG	34
3.8 Other key related acts	34
3.9 Other key relating strategies, frameworks and charters	36
Chapter 4: Network principles and requirements	39
4.1 Introduction	39
4.2 Who the network is for	39
4.3 The active travel network map	41
4.4 Designated localities	41
4.5 Rurality	42
4.6 Mapping of routes and related facilities	42
4.7 Prioritisation and network coverage	43

4.8	Map submission	44
4.9	Approval	45
4.10	Publishing the map	45
4.11	Continuous improvement	46
4.12	Review (and partial review) of the map	47
4.13	Planning status of the map	47
Chapter 5: Consultation, engagement and promotion		49
5.1	The duty to consult	49
5.2	Engagement and consultation principles	50
5.3	Promotion	53
Chapter 6: Monitoring and reporting		56
6.1	Introduction	56
6.2	Reporting duties under the Active Travel (Wales) Act	56
6.3	A strategic approach	57
Part 2: Planning and design for active travel in Wales		58
Chapter 7: Introduction to planning and design		59
7.1	Planning and design for active travel in Wales	59
7.2	Status of the Active Travel Act guidance	59
7.3	Highway design and the active travel act	60
7.4	Trunk roads	65
7.5	Local roads	67
7.6	New developments	67
7.7	Land acquisition	68
7.8	Innovation and experimentation	70
7.9	Design elements	70
7.10	Keeping standards up to date	71
Chapter 8: Engagement and consultation methods		72
8.1	Introduction	72
8.2	Addressing the principles	73
8.3	Tools for participation and consultation	75
8.4	Active travel network map (ATNM) engagement and consultation	77
8.5	Scheme delivery and consultation	78

Chapter 9: User needs	81
9.1 Similarities and differences	81
9.2 Principles for user needs	82
9.3 Inclusive design	83
9.4 Minimising user effort	85
9.5 Pedestrian needs	87
9.6 Dimensions for pedestrian routes	90
9.7 Gradients for pedestrian routes	93
9.8 Surface material for pedestrian routes	94
9.9 Cyclists' needs	95
9.10 Creating opportunities for encouraging e-cycles	97
9.11 Dimensions of cycles commonly in use	98
9.12 Headroom for cycle routes	100
9.13 Typical cycling speeds	100
9.14 Visibility dimensions for cycle routes	101
9.15 Gradients on cycle routes	103
9.16 Space required for cycling	105
9.17 Cycle tracks and cycle lanes – usage and widths	106
9.18 Additional width adjacent to vertical features	108
9.19 Additional width adjacent to carriageway	108
9.20 Width considerations for on-carriageway cycling	109
9.21 General lane widths on carriageways	110
9.22 Width at pinch points	111
9.23 Surfaces for cycle routes	112
Chapter 10: Network planning and map preparation	113
10.1 Introduction	113
10.2 Information gathering and ATNM integration with policies, plans, programmes and infrastructure	115
10.3 Network planning for walking	118
10.4 Network planning for cycling	121
10.5 Route auditing and assessment	128
10.6 Audit and mapping process for existing routes	131
10.7 Existing Routes - Pass with Statement	132
10.8 Future Routes	132
10.9 Active travel network map	133
10.10 Routes on land not owned by a local authority	135
10.11 Validation of active travel network maps	135
10.12 Submitting the active travel network map	136
10.13 Publishing the map	136
10.14 Partial review of the map	137
10.15 Prioritising the active travel routes	137

Chapter 11: Designing for active travel routes and links	141
11.1 Introduction	141
11.2 General design considerations	142
11.3 Link design considerations	143
11.4 Cycling routes and links	144
11.5 Co-design	146
11.6 Reducing the speed and volume of motor vehicles DE201, DE202, DE203 and DE204	147
11.7 Speed reduction - traffic calming DE201, DE202 and DE203	149
11.8 Filtered permeability and low traffic neighbourhoods	150
11.9 Quiet streets DE205	151
11.10 Cycle streets DE206	152
11.11 Pedestrian prioritised and informal streets	153
11.12 Vehicle restricted areas	154
11.13 Reallocation of road space	155
11.14 Separation of cyclists and pedestrians	156
11.15 Type of separation	158
11.16 Shared use	158
11.17 Pedestrian routes and links DE101 and DE102	160
11.18 Gradients, ramps and steps DE103 and DE104	161
11.19 Wheeling ramps DE105	162
11.20 Traffic lane widths and car parking	162
11.21 Contraflow cycling DE301 and DE302	163
11.22 Cycle lanes DE303 and DE304	164
11.23 Car parking/loading and cycle lanes DE305	164
11.24 Cycle lanes at side roads DE306	165
11.25 Cycle lanes with removal of centre lines DE307	165
11.26 Cycle lanes with light separation DE308, DE309 and DE310	166
11.27 Stepped cycle lanes or tracks DE311 and DE312	166
11.28 Cycle tracks alongside the carriageway DE313	167
11.29 Cycle tracks in centre of carriageway DE314	168
11.30 Transitions between cycle tracks and the carriageway DE315	169
11.31 Cycle lanes/tracks at bus stops DE501, DE502, DE503 and DE504	170
11.32 Pedestrian and cycle tracks, away from road DE402 and DE403	171
11.33 Cycling on rural roads	175
11.34 Temporary infrastructure	176
11.35 Cyclists and public transport routes	178
11.36 Bus lanes and bus-only streets DE505	178
11.37 Cycling and trams	179

Chapter 12: Designing for active travel junctions and crossings	181
12.1 Introduction	181
12.2 Crossing and junction design – general principles	181
12.3 Considerations for pedestrian and cycle crossings	183
12.4 Crossing types	184
12.5 Priority junctions	185
12.6 Uncontrolled crossings	189
12.7 Unsignalised controlled crossings	192
12.8 Signalised crossings away from junctions	193
12.9 Crossings at signal-controlled junctions	194
12.10 Roundabouts	203
12.11 Grade separated crossings	208
Chapter 13: Integration with public transport and cycle hire	211
13.1 Introduction	211
13.2 Active travel to and from interchanges and public transport stops	212
13.3 Active travel at interchanges and public transport stops	214
13.4 Area wide cycle hire schemes	216
13.5 Park and cycle	218
13.6 Carriage of cycles on public transport	218
13.7 Carriage of cycles on buses	219
Chapter 14: Related facilities	221
14.1 Introduction	221
14.2 Public toilets	224
14.3 Washing and changing facilities	224
14.4 Planting and hard landscaping	225
14.5 Litter bins	228
14.6 Count displays	228
14.7 Signage	229
14.8 Cycle parking	238
14.9 Public cycle maintenance facilities	250
14.10 E-cycle charging facilities	250
Chapter 15: Construction, maintenance and management of active travel routes including streetworks	253
15.1 Construction	253
15.2 Drainage	258
15.3 Access controls	262
15.4 Fencing and hedgerows	264

15.5	Lighting	265
15.6	Maintenance and management	266
15.7	Pedestrian and cycle traffic at streetworks and construction sites	271
Chapter 16: Monitoring and evaluation		274
16.1	Introduction	274
16.2	Why monitor and evaluate?	275
16.3	How to approach monitoring and evaluation	276
16.4	Data gathering tools	278
16.5	Recommended approach	280
16.6	Analysis, results and outputs	282
Glossary of commonly used technical terms		285
Appendices		288
Appendix A	Powers and duties created by the Active Travel (Wales) Act 2013	288
Appendix B	Direction designating localities under the Active Travel Act	291
Appendix C	Aberystwyth Map	309
Appendix D	Model engagement report	310
Appendix E	Examples of ATNMs	313
Appendix F	Annual Report	316
Appendix G	List of Design Elements	320
Appendix H	Audit Tools	454
Appendix I	Legal procedures	461
Appendix J	Network planning background information	465
Appendix K	Example prioritisation process	469



Foreword



Active travel is a key priority in the Welsh Transport Strategy – Llwybr Newydd – and is identified at the top of the sustainable transport hierarchy that guides all our transport activities. The circumstances for active travel planning and delivery in Wales have changed significantly over the 7 years since the making of the Active Travel (Wales) Act in late 2013 and the publication in 2014 of the original two accompanying statutory guidance documents – the delivery guidance and the design guidance.

Since 2015, the Well-being of Future Generations Act has steered the public sector in Wales to think and act in pursuit of joint overarching well-being goals and in ways that embed sustainable development principles. Active travel has been recognised as helping to make progress towards many of these goals across sectors and is being promoted by actors in different spheres. Most notable in this respect is its direct contribution to physical and mental health and well-being. The urgency

to respond to the global climate crisis has continued to grow and resulted in the Welsh Government’s legally binding commitment earlier this year to achieve net zero emissions by the middle of this century. The need to achieve a strong modal shift towards the emission free modes of walking and cycling and to do so swiftly, is therefore widely recognised. Consequently, Llwybr Newydd the new Wales Transport Strategy sets a mode share target of 45% of journeys to be made by walking, cycling and public transport by 2040.

All of this reinforces what was known in 2013 when the Active Travel (Wales) Act was passed: That walking and cycling provide a practical and vital response to help Wales meet its environmental and health imperatives. It also adds pressure to step up the delivery of high quality active travel networks that enable more and more people to regularly walk and cycle for utility journeys instead of using a car.

Levels of active travel in Wales nationally have remained low, though there have been encouraging signs of change in some places and the disruption to normal travel patterns caused by the pandemic throughout 2020 has led to increased walking and cycling, albeit mainly for exercise. We need to grasp the opportunity to convert this increased appetite from leisure to utility journeys.

To allow us to rise to the mode shift challenge, dedicated budgets for active travel infrastructure in Wales have been increased from under £5 per head of population per year when the act was made, to well over £20 in 2021. Sustaining this funding level must be justified by ensuring it is spent on networks and schemes that are well planned and designed and result in additional active travel journeys.

This revised guidance provides the mandate to act on this imperative to deliver high quality active travel networks and schemes that maximise the benefit of the investment. Building on the draft guidance published for consultation in 2020, it brings together the previous two sets of statutory guidance and updates them, drawing on a wide range of sources, most notably user experiences, public and stakeholder consultation feedback, policy changes, new infrastructure and technology developments.

Where appropriate, the guidance aligns with the Department for Transport's LTN1/20 on cycling infrastructure design. The review of this guidance was carried out through a partnership approach drawing on wide-ranging expertise from the public, private and third sector. I am very grateful to all the organisations and individuals who responded to the consultation and for the contributions by all the organisations involved in the post-consultation editing.

Areas where the previous guidance was deemed to leave too much room for interpretation were strengthened and clarified. Compliance with this guidance will be required to secure WG funding for future schemes.

Our vision is clear – for walking and cycling to become the normal choice for shorter journeys and we look forward to working with partners to turn this vision into reality.

Lee Waters MS

Deputy Minister for Climate Change

Acknowledgements

Phil Jones Associates and Chris Roberts were lead reviewers for the 2020 consultation draft. Post consultation editing was undertaken by Welsh Government, Transport for Wales, Sustrans and Phil Jones Associates, with additional input from Access Design Solutions and Mott MacDonald. The original design elements, which still form the basis of most of the design elements in the revised draft, were created by Arup.



Vision and priorities

Our Vision

Is for walking and cycling to be the natural mode of choice for short everyday journeys, or as part of a longer journey in combination with other sustainable modes.

Our 15-year ambitions

Are for a comprehensive network of safe, direct, cohesive, comfortable and attractive walking and cycling routes within and connecting to key settlements across Wales.

Our five-year priorities

As set out in Llywybr Newydd, over the next five years we will work with partners to:

- continuously develop a network of local routes for walking and cycling to connect people with the places they travel to for everyday journeys
- refresh the plans for Active Travel Network Plans (ATNMs) every three years, based on extensive consultation with a particular emphasis on people who do not currently walk or cycle for local trips

- include education facilities on ATNMs, including Welsh-medium education
- train and develop professionals in best practice active travel design and guidance to ensure high quality infrastructure is put in place
- develop a package of 'soft' behaviour change measures, such as aiming to make cycle training available for all and travel planning, to complement 'hard' infrastructure investment
- put in place a policy framework that ensures that all new developments, including new school and health facilities, make provision for walking and cycling from the outset
- encourage all schools to have an active travel plan and adopt actions to slow traffic and widen pavements around schools
- change the default speed limit from 30mph to 20mph in built-up areas to reduce traffic related injuries and fatalities and make walking and cycling safer and more attractive
- support safer, better cycle paths and more space for walking and cycling through closing roads for vehicle traffic, more facilities for pedestrians, and support for cycle training and safety schemes for all road users
- introduce pilot schemes to make use of electrically assisted bikes (e-bikes) and e-cargo bikes an affordable option for more individuals and businesses
- work with partners on behaviour-change programmes to encourage uptake of healthy and active travel through for example, workplace schemes, including provision of facilities such as cycle parking
- work with UK partners on a regulatory framework for micro-mobility modes such as e-scooters
- manage and evaluate the active travel fund which supports local authorities to develop and deliver active travel schemes, including best-practice sharing and regional collaboration
- work towards 'safe cycling from village to town' giving villages safe cycling access to the nearest town and creating hub-and-spoke active travel corridors connecting market towns and other significant local centres to surrounding villages and outlying developments

Part 1

Delivery of Active Travel in Wales

Chapter 1: Introduction

1.1 Active travel in Wales

- 1.1.1 Active travel is a term used to describe walking and cycling for purposeful journeys to a destination, or in combination with public transport. Whilst walking and cycling are in themselves healthy activities that are to be encouraged, it is when they displace car journeys that they deliver significant benefits for the health and well-being of Wales. Achieving modal shift by displacing private car journeys with walking and cycling and public transport is at the heart of Llwybr Newydd, the Wales Transport Strategy.
- 1.1.2 Increasing levels of active travel contributes to the achievement of all seven of Wales' Well-being Goals. It was to reap these benefits that the then National Assembly for Wales passed the Active Travel Act (the 'Act') into legislation in 2013. The act aims to make walking and cycling the most natural and normal way of getting about. For this to happen, many more people will have to choose walking and cycling as a means of transport. The provisions of the act therefore put in place the conditions that will allow many more people whose current mode of travel is the car to switch to more sustainable modes for shorter journeys and facilitate access to public transport as part of longer distance journeys.
- 1.1.3 The definition of an active travel journey therefore includes travel to work, travel to school and other educational facilities, travel to the shops, travel to leisure facilities, travel to public transport interchanges and so on. The definition of an Active Travel Route excludes those for purely recreational use, such as an off-road circuit or mountain bike trail.
- 1.1.4 In practice, however, the best active travel routes will also be widely used for recreation. While the aim of the act is to promote walking and cycling as a mode of transport, the Welsh Government also strongly supports recreational walking and cycling and cycle sport. Walking and cycling for leisure is strongly linked to a person's willingness to travel actively. A high level of recreational walking and cycling on a route is an indicator of a high-quality route and should be considered a sign of success. However, such usage is secondary; active travel resources should only be invested in routes likely to produce modal shift and/or improve conditions for existing active travel users.
- 1.1.5 When compared with many other European countries, levels of active travel in Wales are low. The main barrier to more people taking up active travel is the perception of danger from motorised transport. Overcoming that perception is key to the success of the act. Unless people can be persuaded that their entire journey can be made safely via active means, potential users of active modes will be discouraged, leading to continued reliance on the car.
- 1.1.6 The number of active journeys people will make will depend on how comprehensive the network of safe routes is and how well the routes connect to/from key destinations, public transport infrastructure, and people's homes.

1.2 The act and this guidance

- 1.2.1 The guidance is issued using the powers of the Welsh Ministers to give guidance under sections 2(6), 2(9), 3(4), 4(5), 5(2) and 7(2) of the Active Travel Act. For ease of reference, throughout this document it will be known as 'this guidance'.
- 1.2.2 The document is published by the Welsh Government for use throughout Wales and the contents must be considered when planning, designing and maintaining active travel routes and related facilities, enhancing provision for walkers and cyclists as part of other highway schemes (including planned maintenance work), or when considering the needs of walkers and cyclists as part of new developments, traffic management and road safety schemes.
- 1.2.3 The act requires local authorities in Wales to produce maps of walking and cycling networks, and to deliver year on year active travel improvements along the mapped routes and their related facilities (toilets, cycle parking etc.). These routes should be coherent, direct, safe, comfortable and attractive. The maps shall now be known as Active Travel Network Maps (ATNM) – showing existing routes and future routes which shall combine the Existing Routes Map and the Integrated Network Map required by the act. Full details of the ATNM requirements are provided in chapter 10 along with an explanation of the terms future routes and existing routes.
- 1.2.4 As well as creating the infrastructure, the act includes provision for making people aware of the existing and future routes through the publication of the maps and for the promotion of active travel as a means of transport.
- 1.2.5 It requires highways authorities in Wales to make enhancements to routes and facilities for pedestrians and cyclists in all new road schemes and to have regard to the needs of active users in a range of other highway authority functions, such as maintenance.
- 1.2.6 Further details of the duties outlined within the act are found in chapter 2 and the full text of the act is available [here](#).
- 1.2.7 This guidance is split into two parts:

Part 1: provides an outline summary of the aims, processes and key considerations associated with the act. Part 1 signposts to relevant chapters of this guidance as an aid for the various partners who will be involved in the implementation of the act, but who may not require detailed technical information on active travel design.

Part 2: provides detailed technical advice on how infrastructure should be planned and designed. All personnel involved in highway planning and design will need to be familiar with both parts, but particularly with part 2.

Throughout this guidance different verb forms are used to make a distinction between statutory requirements and advice. '**Must**' indicates a legislative or regulatory agreement; '**shall**' indicates where Welsh Government stipulates a requirement; '**should**' indicates advice expressed as a recommendation and '**may**' indicates advice expressed as a permissible approach.

Within Part 2, technical guidance refers to ‘**desirable**’ and ‘**absolute**’ minimum (or in some cases maximum) provision for infrastructure. Figures marked ‘**desirable**’ provide a basic level for the relevant provision and figures marked ‘**absolute**’ relate to the measurements that shall be adhered to for that infrastructure or facility.

- 1.2.8 Local authorities must have regard to this guidance when exercising the functions to which this guidance relates. All references to local authorities are to be taken as references to city, county and county borough councils. In line with the duties of the act, this guidance is for all parts of the local authority, not just in its capacity as the local highway authority. This guidance will also be of relevance to anyone involved in the planning, delivery, monitoring, evaluation, promotion, maintaining or campaigning of/for active travel.
- 1.2.9 The implementation of a local authority’s duties under the act will require effective collaboration amongst departments. An understanding of the responsibilities of each department is therefore key. These are set out within the table below using generic functions (rather than specific names which may differ between authorities). All departments will need to be aware of the overall aims of the act as there may often be overlap between departments, for example, in planning and designing active travel access to a new school. This table also applies to Welsh Government.

Table 1.1 – Function and area of relevance

Function	Area of relevance	Chapter/section	
		part 1	part 2
Corporate services and estate management	Equalities	3.4	
	The duties on local authorities	2.1	
	Definitions	1.3	
	Publishing the maps	4.10	
	Cross-boundary route planning with neighbouring authorities		7.4 10.2 10.4
	Promoting active travel	5	
	Stakeholder participation, engagement and consultation	5	8
	Inclusive design		9 10
	Prioritising and delivering the active travel schemes		10.15
	Monitoring	6	
Education	Children and young people	5.1	
	Learner travel measure	3.7	13.2
	Consultation/engagement	5	8
	Promoting active travel	5	
	Active travel map consultation	5.1	8.4
Youth services	Children and young people	5.1	
	Consultation/engagement	5	8
	Promoting active travel	5	

Function	Area of relevance	Chapter/section		
		part 1	part 2	
Social services	Equalities	3.4	9	
	Consultation/engagement	5	8	
Planning, growth and regeneration	Planning Policy Wales	3.4		
	Planning status of the active travel network map	4	7 10.2	
	Funding the network – s106 and CIL		10.2	
	New developments		7.6	
	Inclusive design		9 10	
	Network planning		10	
	Cross-boundary route planning with neighbouring authorities		7.4 10.2 10.4	
	Integration with public transport		13	
	Street furniture and cycle parking		14	
	Construction, maintenance and management		15	
	Development control and conservation	Environment Act	3.7	
Planning Policy Wales		3.4		
Planning status of the active travel network map			7 10.2	
Funding the network – S106 and CIL			10.2	
New developments			7.6	
User needs			9	
Street furniture and cycle parking			14	
Construction, maintenance and management			15	
Environmental health	User needs		9	
Highways and transportation – all of the guidance is relevant. Staff not directly involved in active travel need to be particularly aware of the sections listed here:	Provision for walkers and cyclists when changes are made to the highway		7	
	User needs		9	
	Network planning		10	
	Cross-boundary route planning with neighbouring authorities		7.4 10.2 10.4	
	Designing for walking and cycling		11 12	
	Integration with public transport		13	
	Creating, improving and managing highways		15	
	Cycle and pedestrian traffic at street works and construction sites		15	
	Public health	Promoting active travel	5	
		Prioritising and delivering the active travel schemes		10.15
Recreation and tourism	Publishing the map	4.10		
	Promoting active travel	5		
	General provisions for traffic regulation and traffic regulation in special cases		7	
	Integration with public transport		13	
	Signs for pedestrians and cyclists		14	

- 1.2.10 The duties of the act relate to local authorities and Welsh Ministers, but Public Services Boards with their strategic, cross-service remit, as well as Welsh Government supported bodies, such as Transport for Wales, Natural Resources Wales, Cadw, Public Health Wales and Sport Wales; all have the potential to fulfil an important role at the local level in championing and overseeing active travel delivery across partners' activities.
- 1.2.11 The Welsh Government provides funding for a variety of large investment schemes under programmes such as 21st Century Schools and for NHS projects. These types of schemes are important trip generators. The quality of provision for walking and cycling access for staff and pupils, or staff, patients and visitors respectively must be considered in all education and health related projects which bid for Welsh Government capital and revenue funding. This consideration will form part of the scrutiny and appraisal process of each proposal.
- 1.2.12 Whilst the Local Authority generally acts as the local Highway Authority (and therefore the duties within the act refer to the Local Authority), Community and Town Councils may also be able to facilitate active travel. Under the Local Government Act (2000) Community Councils have the power to improve factors they consider are likely to achieve the promotion or improvement of the economic, well-being, social well-being or the environmental well-being of their area. Where applicable, Town and Community Councillors should therefore be familiar with the overall aims of the act.
- 1.2.13 This guidance will be reviewed and updated based upon feedback from local authorities of their experience fulfilling their duties under the act and the usefulness of this guidance in supporting them, as well as feedback from other stakeholders. Comments and views on this guidance can be sent to: activetravel@gov.wales

1.3 Definition of an active traveller within the act – walkers, cyclists and other highway users

- 1.3.1 'Active travel' is a useful term to differentiate between walking and cycling as a means of transport and walking and cycling solely for leisure. However, the term is not yet widely understood amongst the general public. Under certain circumstances, it may therefore be preferable to use terms such as "walking and cycling as a means of transport" or "walking and cycling for everyday journeys" to introduce the topic, though the term active travel, with an explanation, should be used at some point in any communications relating to the act.
- 1.3.2 The term "walker" (or within this guidance also pedestrian) embraces not only those who travel by foot (walking or running), but also users of wheelchairs or other mobility aids. Somebody using an electric wheelchair, mobility scooter, or similar vehicle would also be considered a walker rather than a motorised travel user.

- 1.3.3 “Cycling” and “cyclist” refers to users of pedal cycles, but not motorbikes. This definition of cycling includes e-cycles (also called electric assisted pedal cycles, electric cycles or pedelecs). They are referred to within this guidance as e-cycles. These are cycles where electric motors assist the cyclist by providing extra power to the pedals, making it easier to cycle. They are distinct from electrically powered motorbikes, where the motor provides all propulsion. Non-standard cycles, such as adapted cycles (cycles or tricycles. specially adapted for use by disabled people), cargo cycles and recumbents are also included within the definition of cycling.
- 1.3.4 Micro-scooters, roller blades, skateboards and other similar modes of travel are not included in the statutory definition of active travel. However, these modes of travel can complement walking and cycling. For example, scooters are widely used by children for travel to school. Their use should not be discouraged or impeded when they provide an attractive form of transport. E-scooters are a fast developing form of transport, the use of which is currently illegal on public roads and paths in the UK, unless as part of a formal trial. Inconsiderate use of micro-scooters, skateboards and similar can negatively impact on disabled people particularly people with sight loss. Awareness raising of the potential conflicts should be included in active travel related training given to young people and through other promotional activities.
- 1.3.5 Walking and cycling are brought together in the Act because they share a number of characteristics. However, that does not mean they can be treated the same. The cycle is a machine that can travel at speed which makes it an ideal replacement for the motor car for many journeys, but it also means that it can be unsuitable for sharing provision with pedestrians in many contexts. Part 2 contains further advice on appropriate and desirable provision for certain scenarios.
- 1.3.6 Equestrianism is overwhelmingly for leisure purposes rather than as a mode of transport as it rarely displaces a car journey. Forms of equestrian travel (horse riding, carriage driving, pony and trap etc.) are not considered forms of active travel. However, in delivering the provisions of the Act, local authorities should be aware that equestrians are vulnerable road users and should not restrict equestrian access to routes that they currently enjoy. Bridleways can be used by equestrians, walkers and cyclists and so may form part of an active travel route. Enhancements to bridleways should not impede equestrian use or require them to use a less safe route instead. In some cases, it may be more appropriate for all users if separate provision is made for walkers, cyclists and equestrian users. Where active travel routes are planned on an alignment for which there is also high demand from horse riders, the feasibility of accommodating them should also be assessed.

1.4 Other definitions

- 1.4.1 A range of definitions included within this guidance are provided within the accompanying [glossary](#).



1914 NEUADD COFFA 1918

FOR SALE

ARWERTH

Let us
Apertu, ent
evetop, bent
amper, n. v. n.

St. John's
Church

Chapter 2: The duties on local authorities and Welsh Ministers

This chapter summarises the duties of the Active Travel Act.

In preparing, consulting upon, publishing, submitting, reporting on and revising their active travel network map, in accordance with this guidance, local authorities will discharge their duties under the act to prepare, consult upon, publish, submit, report on and revise their Existing Routes Map and Integrated Network Map as defined in the legislation.

Additional duties that must be acted on by both local authorities and Welsh Government are to take reasonable steps to enhance the provision made for walkers and cyclists and to have regard to the needs of walkers and cyclists when developing highway schemes.

2.1 The duties under the Active Travel (Wales) Act 2013

2.1.1 The duties arising from the act apply to the whole authority and government and are not specific to one department. Table 1.1 includes a guide to which parts of this guidance are particularly relevant to which government functions.

2.1.2 Key duties of the act are as follows, with the relevant section of the act given in brackets:

- for local authorities to produce maps of existing active travel routes and related facilities in a local authority's area and of the future and improved active travel routes and related facilities needed to create integrated networks for active travel in a local authority's area and to submit these maps to the Welsh Ministers for approval within a prescribed timetable
- requiring local authorities to have regard to those maps in preparing transport policies and to ensure that there are new and improved active travel routes and related facilities (section 6)
- requiring the Welsh Ministers (section 8) and local authorities to report on levels of active travel
- requiring the Welsh Ministers and local authorities, in carrying out certain functions under the Highways Act 1980, to take reasonable steps to enhance the provision made for walkers and cyclists and to have regard to the needs of walkers and cyclists in the exercise of certain other functions (section 9)
- requiring the Welsh Ministers and local authorities to exercise their functions under this act so as to promote active travel journeys and secure new and improved active travel routes and related facilities (section 10)

- 2.1.3 This guidance explains what these duties mean in practice and advises the Welsh Ministers and local authorities on how to meet these duties. Appendix A sets out the powers and duties that were created by the act, and the bodies affected by the powers and the duties.
- 2.1.4 Local authorities shall prepare an active travel network map (ATNM) which shall incorporate the Existing Routes Map, with its associated facilities and statements, and the Integrated Network Map required by the act. Welsh Government's Data Map Wales system enables local authorities to compile the ATNM and allows the two types of routes to be differentiated.
- 2.1.5 Part 1 introduces the basic requirements for local authorities and the Welsh Ministers under the act. Part 2 provides further details on the delivery methods for these requirements.
- 2.1.6 The process local authorities are to follow in preparing their active travel network maps is set out in figure 2.1. The corresponding section of guidance is given within the table for where full details of each step of the process can be found.

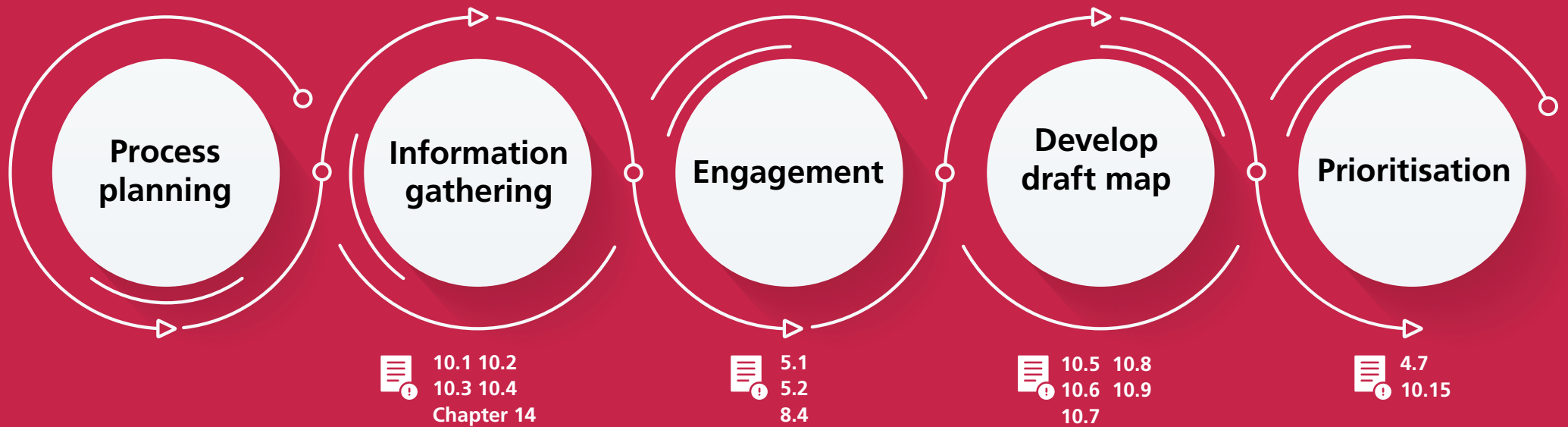

- Assess resources and time needed
- Develop engagement plan
- Assess local priorities
- Consider equalities requirements
- Consider how to integrate with programmes across authority departments, particularly highway maintenance, and relevant local and national plans
- Review systems for working on routes that cross authority boundaries

- List of key destinations
- Identify where local short trips are taking or are likely to take place
- Identify barriers that impact on active travel uptake for these trips
- Identify new developments
- Access sources of data
- Check for demand for routes outside of designated localities
- Review facilities to be included on the map

- Implement engagement plan by contacting stakeholders and members of the public
- Ask people to identify gaps in the network to serve their utility journey needs
- Use a variety of engagement methods appropriate to each

- Audit existing routes using audit tools (Appendix H)
- Identify future routes and improvements to existing routes
- Draw on data collected in previous information gathering stage

- Determine which routes are most likely to deliver priorities and Welsh Government's priority of maximising the number of active travel journeys
- N.B. route prioritisation can be an iterative process undertaken before and after statutory consultation

Figure 2.1 - Summary of ATNM preparation process

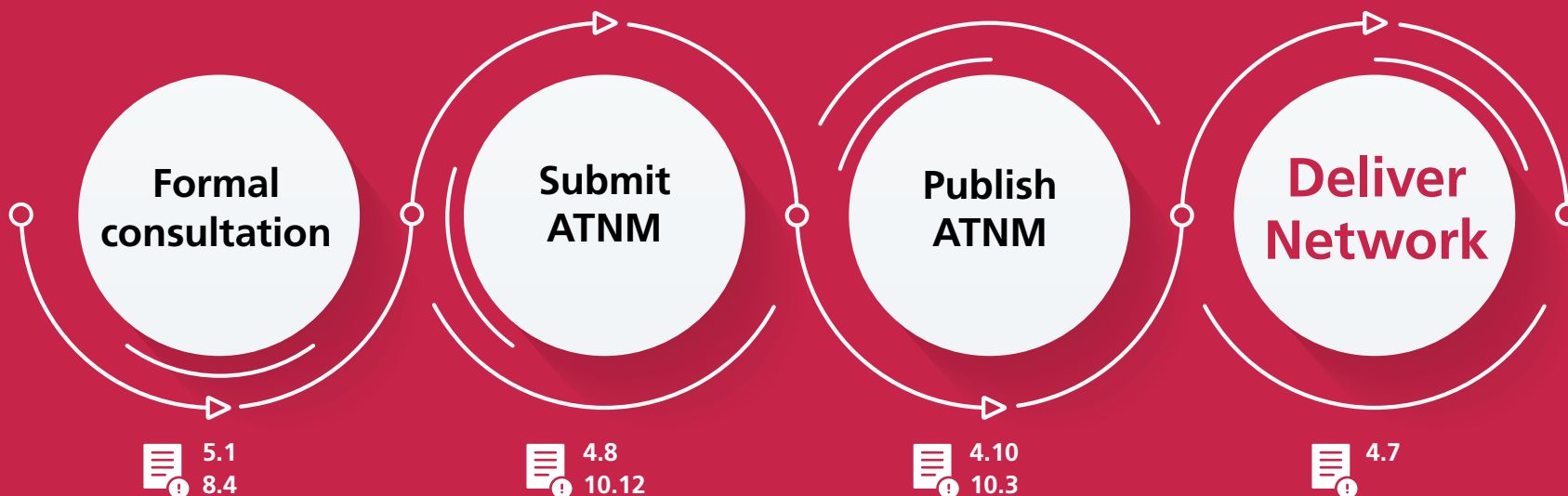

- Undertake 12 week statutory consultation process
- Ensure compliance with Equality Act 2010
- Follow locally determined procedures for cabinet/scrutiny committee approvals

- Submit ATNM to Welsh Ministers
- Also send associated reports;
 - engagement and consultation report
 - scheme prioritisation

- Publish the approved ATNM along with route statements and prioritisation table

- Deliver network in accordance with prioritisation plan

2.2 Duties for provision for walkers and cyclists when changes are made to the highway

- 2.2.1 As described within the act, certain duties are placed on Welsh Government and local authorities when fulfilling functions that have an impact on transport networks and related infrastructure.
- 2.2.2 The act requires that, as highway authorities, local authorities and the Welsh Ministers must take reasonable steps to enhance the provision made for walkers and cyclists in their exercise of functions under Parts 3, 4, 5, 9 and 12 of the Highways Act 1980 as far as it is practicable to do so. Chapter 7 sets out the full statement of duties in relation to the Highways Act that must be followed.
- 2.2.3 The act also requires that highway authorities have regard to the needs of walkers and cyclists in exercising their functions under Parts 1, 2, 4 and 7 of the Road Traffic and Regulation Act 1984, Part 3 of the New Roads and Street Works Act 1991 and Part 2 of the Traffic Management Act 2004.

Case Study

Example 1: when undertaking road routine resurfacing works, local authorities must take the opportunity to include features that improve conditions for walkers and cyclists e.g. installing dropped kerbs where they are absent, or making changes to road markings to favour walkers and cyclists.

Example 2: Welsh Government were developing a road improvement scheme at Junction 19 on the A55 between Glan Conwy and Llandudno Junction to address safety concerns on the roundabout by installing traffic signals and localised widening and markings, whilst also upgrading the surfacing and lighting. The existing footways on the roundabout were sub-standard and provided no controlled crossings over the slip roads or across the linking county roads.

Active travel was considered as part of the WelTAG process and the opportunity to enhance active travel provision and reduce community severance arose as part of the process. Further engagement with the local community, local authority and active travel users groups took place which led to several design enhancements and the final scheme was opened in January 2021.

The scheme provides safe, separated active travel provision and crossing facilities through the junction, linking the north and south into existing local authority active travel routes, some of which will also be enhanced in the near future.



2.3 Review of the act

- 2.3.1 The Welsh Ministers are required to review the act no later than five years after the deadline for the production of the first integrated network map (now the ATNM). This review must assess the success of securing new active travel routes and related facilities and improvements of existing active travel routes and related facilities. It will also assess progress in encouraging more people to walk and cycle more often and the lessons learnt during the delivery of the legislation.



Chapter 3: Policy and legislative context

This chapter outlines key policies and legislation that relate to the enabling and promotion of active travel in Wales. Since the making of the Active Travel Act, the policy and legislative framework for active travel in Wales has been strengthened through the emergence of significant new and revised policies and laws and these must be considered in parallel with the act when developing active travel routes and facilities.

3.1 Introduction

- 3.1.1 Since its introduction in 2015 the Wellbeing of Future Generations (Wales) Act has dramatically changed the work of public bodies in Wales. Through this, it has broadened both the scope and the approaches taken to how we must plan and deliver for active travel in Wales. Most recently Llwybr Newydd, the new Wales Transport Strategy has set a new direction for transport across all modes. It has been strongly shaped by the need to transform our transport system to help meet the Welsh Government's binding net zero carbon target by 2050.
- 3.1.2 Planning Policy Wales and Future Wales, the new National Plan have significantly strengthened the alignment between transport and planning objectives further in their enhanced recognition of the role active travel plays in sustainable placemaking. This will affect the planning of large scale new developments and also how schemes within existing built up areas are considered. The Equality Act has been in place since 2010, and the understanding of how it needs to be reflected in our planning and design and the tools available to do so continue to improve. At the end of the chapter we summarise other laws and policies and how they relate to active travel.

3.2 Well-being of Future Generations (Wales) Act 2015

- 3.2.1 The Well-being of Future Generations Act applies to devolved public bodies in Wales, and aims to improve the social, economic, environmental and cultural well-being of Wales through seven well-being goals. Active travel can contribute to all of these goals.
- 3.2.2 The Well-being of Future Generations Act also sets out 'five ways of working' that must guide how public sector organisations work towards these objectives. These are **Involvement – Integration – Prevention – Collaboration – Long-term**.

Figure 3.1 – How active travel contributes towards meeting the well-being goals

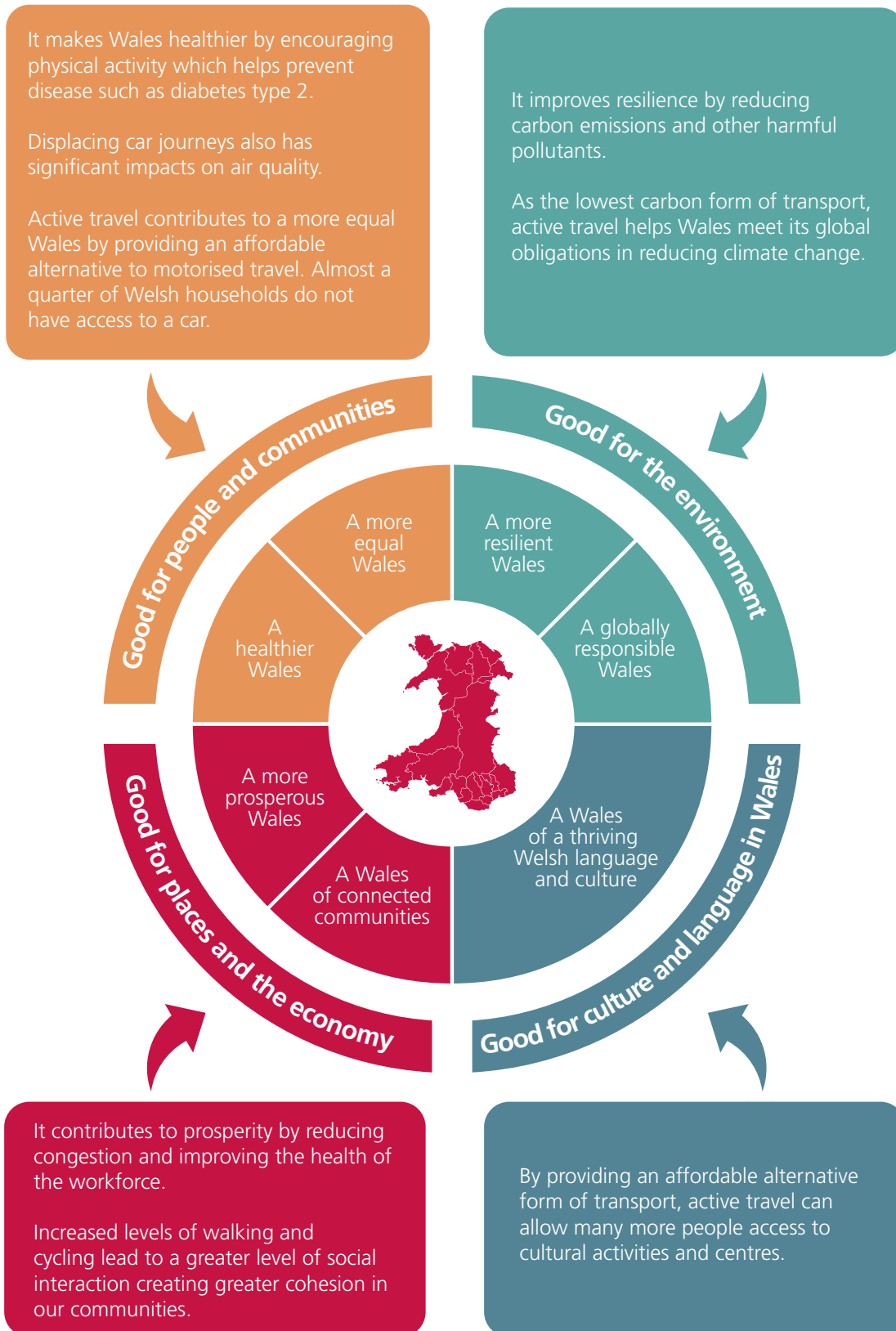

3.3 Llwybr Newydd – A New Wales Transport Strategy

3.3.1 Published in 2021, Llwybr Newydd sets out the vision for an accessible, sustainable and efficient transport system in Wales. Within the strategy there are separate mini-plans relating to specific aspects of transport including active travel. The vision for active travel is therefore mainstreamed at the highest level of transport strategy:

“In line with the Active Travel (Wales) Act we want walking and cycling to become the normal choice for shorter journeys, because active travel is better for our health, our environment and the economy.”

- Llwybr Newydd has three headline priorities for the next five years, which are further expanded in the mini-plans. The priorities will be reviewed as circumstances and technology change.
- **Priority 1:** We will plan ahead for better physical and digital connectivity, more local services, more home and remote working and more active travel, to reduce the need for people to use their cars on a daily basis.
- **Priority 2:** We will actively aim to achieve a shift away from private car use to more sustainable transport modes for the majority of journeys. We will invest in low-carbon, accessible, efficient and sustainable transport services and infrastructure that enable more people to walk, cycle and use public transport, and low-emissions vehicles.
 - We will provide safe, accessible, well-maintained and managed transport infrastructure. We will also future-proof it to adapt to climate change and facilitate more sustainable transport choices. Where we need new transport infrastructure, we will use the Sustainable Transport Hierarchy to guide decisions.
- **Priority 3:** We will encourage people to change their travel behaviour to use low-carbon, sustainable transport.

3.3.2 When we invest in transport infrastructure and services, we will use the sustainable transport hierarchy to give priority to walking and cycling and public transport ahead of private motor vehicles.

3.3.3 The active travel mini-plan in Llwybr Newydd sets out how the five ways of working should be applied when planning and designing interventions and schemes to increase active travel. The fourteen priorities from the active travel mini-plan are listed in the opening section of this document under the vision and priorities section.

Figure 3.2 – Llwybr Newydd vision and priorities

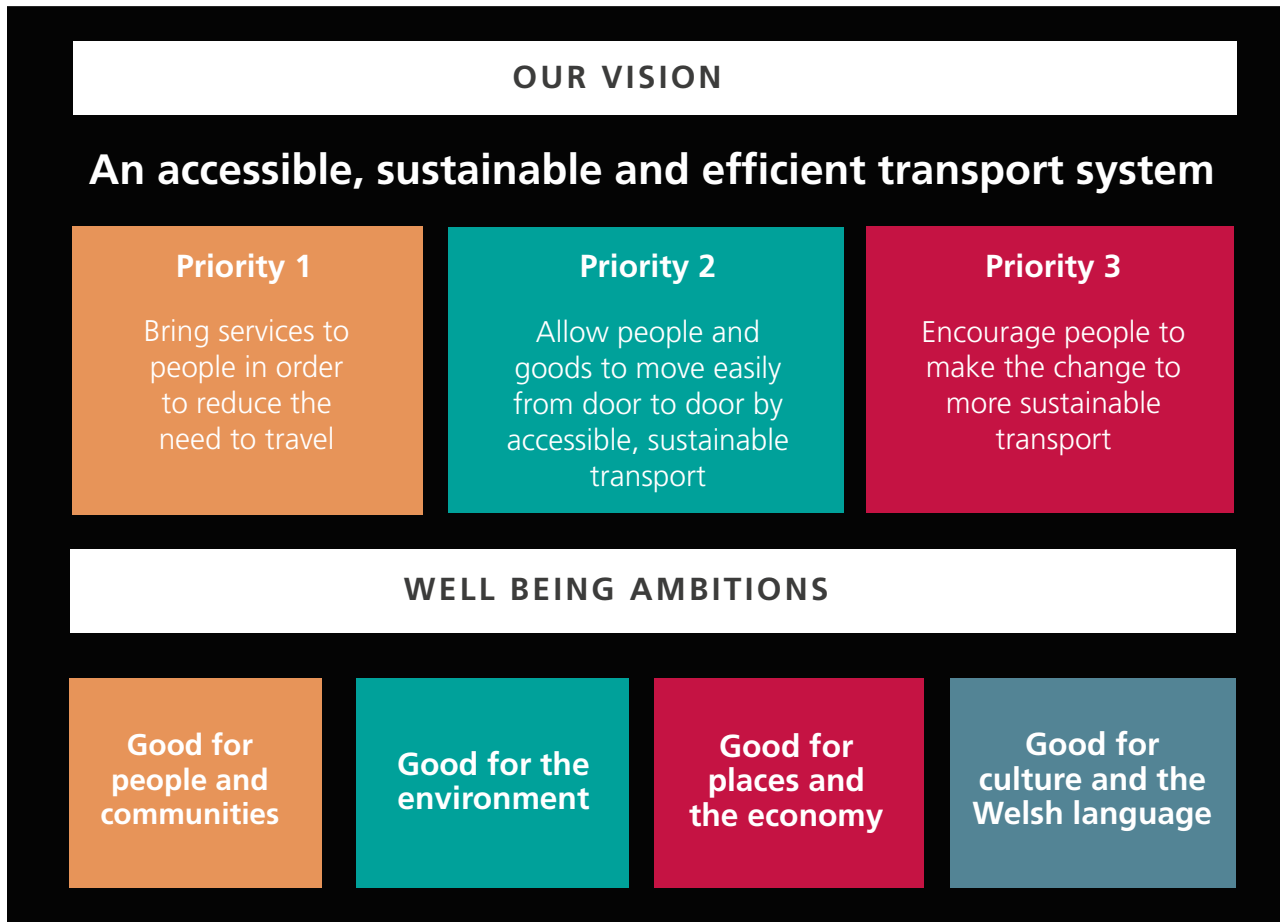

Figure 3.3 – Sustainable transport hierarchy

The Sustainable Transport Hierarchy

We will continue to make best use of existing transport infrastructure by maintaining and managing it well.

We will also adapt it to a changing climate and upgrade it to support modal shift.

Where we need new infrastructure, we will use the Sustainable Transport Hierarchy.



Walking and Cycling



Public Transport



Ultra-Low Emissions Vehicles



Other Private Motor Vehicles

3.4 Equality Act (2010)

3.4.1 The Active Travel Act should be implemented in such a way that it enriches the lives of as many people as possible. Developing a transport system that is not so heavily dependent on the private car and that integrates walking, cycling and public transport effectively can bring great benefits to everyone. However, this potential will only be realised if the needs of people with protected characteristics, particularly disabled people, are properly considered at all stages of creating the network and they, and their representative organisations, are properly involved in engagement and consultations. Under the Equality Act there are nine protected characteristics:

- age
- disability
- gender reassignment
- marriage and civil partnership
- pregnancy and maternity
- race
- religion or belief
- sex
- sexual orientation

3.4.2 Section 149 of the Equality Act 2010 introduced the Public Sector Equality Duty requiring that a public authority must, in the exercise of its functions, have due regard to the need to:

- a) eliminate discrimination, harassment, victimisation and any other conduct that is prohibited by or under the Equality Act
- b) advance equality of opportunity between persons who share a relevant protected characteristic and persons who do not share it
- c) foster good relations between persons who share a relevant protected characteristic and persons who do not share it

3.4.3 The Equality Act 2010 (Statutory Duties) (Wales) Regulations 2011 is supported by Technical Guidance published by the Equality and Human Rights Commission, which provides practical approaches to complying with the Public Sector Equality Duty. The document provides an authoritative, comprehensive and technical guide to the detail of the law including the need for equality plans, objectives and impact assessments.

3.4.4 To ensure duties undertaken in line with the Active Travel Act comply with those of the Equality Act (2010), Equality Impact Assessments (EQIAs) must be carried out throughout the process. This requirement applies to both specific scheme development, and any related activities such as engagement, consultation and promotional activities.

- 3.4.5 Local authorities should seek to establish a dialogue with organisations representing people with protected characteristics, as part of developing a clear understanding of local needs, circumstances and opportunities. See chapter 8 for further guidance on engagement and consultation.
- 3.4.6 Local authorities should also seek to engage with groups that are less likely to undertake journeys by active modes. Previous studies have found that women, older people, disabled people and people from Black, Asian and Minority Ethnic backgrounds are under-represented in uptake of active modes, in particular cycling.

Table 3.1 – Actions to help overcome the common barriers to active travel, for protected characteristic groups

Protected characteristic linked to uptake of active modes	Evidence and barriers	Actions to overcome
Sex	<p>Only 6% of women in Wales currently cycle at least once a month compared with 12% of men</p> <p>Women also make fewer walking trips, but the difference is less stark</p> <p>There is evidence that women are more likely to be deterred from cycling by perceived dangers of cycling in traffic</p> <p>Women are more likely to have more complex travel patterns and be accompanied</p> <p>There are also cultural and lifestyle issues that impact on women’s propensity to walk and cycle</p>	<ul style="list-style-type: none"> • Design strategies and plans to address, and be evaluated against, how they reduce inequality • Increase diversity and representation in decision making and the transport sector • Improve decision making through better evidence and public engagement • Create better places for everyone to walk and/or cycle in (see Part 2 for specific user needs)
Disability	<p>Evidence suggest one third of disabled people in UK cities would like to start cycling</p> <p>Barriers to transport and the wider built environment can restrict choice for disabled people when considering travel options</p>	<ul style="list-style-type: none"> • Welcome and support all people to undertake active journeys, including: <ul style="list-style-type: none"> • Use of inclusive language and imagery
Age	<p>7% of people aged 65 or over cycle at least once a week, compared to 18% of 16 – 64 year olds</p>	<ul style="list-style-type: none"> • Supporting a combination of behavioural and infrastructural interventions
Race	<p>Sustrans’ Bike Life 2019 survey found that 12% of people from ethnic minority communities cycle once a week, compared to 16% from white groups</p>	

- Further advice on how duties undertaken as part of the act can incorporate and apply to the duties under the Equality Act are considered in further details within subsequent chapters of this guidance, specifically:
 - Chapter 5 – relating to engagement and consultation duties (principles)
 - Chapter 8 – relating to engagement and consultation duties (methods)
 - Chapter 9 – relating to user needs
 - Chapter 10– relating to planning a network
 - Chapter 11 – relating to route design

3.5 Planning Policy Wales

3.5.1 Planning Policy Wales provides the policy framework for the effective preparation of local planning authorities' development plans as well as development management.

3.5.2 In conjunction with Planning Policy Wales, this guidance will support the masterplanning and layout and design of development sites, ensuring that all newly planned development is fully accessible by walking and cycling. This applies to private and public sector development, whether mixed use, housing, employment, or public services such as schools and hospitals. It relates to provision within the site and to connections between the site and nearby services, facilities and active travel networks.

3.5.3 Reducing reliance on the private car as a means of transport is a key part of the Planning Policy Wales (PPW) approach.

- It states: "The sustainable transport hierarchy should be used to reduce the need to travel, prevent car-dependent developments in unsustainable locations, and support the delivery of schemes located, designed and supported by infrastructure which prioritises access and movement by active and sustainable transport."
- It also makes clear that the planning system should support the act: "The planning system has an important role to play in promoting and supporting the delivery of the act and creating the right environments and infrastructure to make it easier for people to walk and cycle, including new and improved routes and related facilities."
- It is clear on the importance of incorporating active travel into new developments: "Provision for active travel must be an essential component of development schemes and planning authorities must ensure new developments are designed and integrated with existing settlements and networks, in a way which makes active travel a practical, safe and attractive choice."
- And "Planning authorities must support active travel by ensuring new development is fully accessible by walking and cycling. The aim should be to create walkable neighbourhoods, where a range of facilities are within walking distance of most residents, and the streets are safe, comfortable and enjoyable to walk and cycle."

- Furthermore, PPW recognises the importance of good infrastructure influencing transport behaviour: “Importantly, sustainable transport infrastructure and services should be prioritised and put in place from the outset, before people have moved in and travel patterns have been established”.

3.6 Future Wales – the national plan 2040

- 3.6.1 Future Wales sets out a spatial strategy that identifies at a strategic level how Wales should grow and change over the next 20 years. It provides a framework for delivering the infrastructure to support this growth and for ensuring that as places change, we must sustainably manage our most important natural resources.
- 3.6.2 The national plan sets out how growth should be shaped around sustainable forms of transport and places that make us and the environment healthier – enabling journeys to be undertaken using active modes is therefore integral to this vision.

3.7 WeITAG

- 3.7.1 WeITAG is a framework to assess the strategic case for proposed changes to the transport system. It contains best practice for the development, appraisal and evaluation of proposed transport interventions in Wales. WeITAG is recommended as the starting point whenever a problem is identified with the transport system or within another area that is affected by, or affects, the transport system. The WeITAG process must be applied to all transport projects funded in part or in full by the Welsh Government, and the process is developed over five stages as seen below.

Figure 3.4 – The five stages of WeITAG



- 3.7.2 The ATNM process requires local authorities to take account of the views of stakeholders and of the evidence gathered to inform network planning when identifying existing and future active travel routes and related facilities. This work can inform the WeITAG process, including development of the Strategic Case, during the identification and preparation of scheme proposals.
- 3.7.3 Further details on the WeITAG principles and process can be found within the Welsh Transport [Appraisal Guidance](#) document.

3.8 Other key related acts

3.8.1 Table 3.2 summarises acts in law that must be considered when delivering duties under the Active Travel (Wales) Act. Methods to incorporate these into active travel schemes and planning is further explained in Part 2, particularly chapters 11, chapter 12 and chapter 15.

Table 3.2 - Other related acts key to delivering the Active Travel (Wales) Act

Act	Overview	Relationship to active travel implementation	Who is this relevant to?
Environment Act (Wales) 2016	Seeks to ensure our natural resources are managed in a sustainable way	Implementation of active travel can contribute to various parts of the act, particularly Part 2: Climate Change Section 6 introduces a duty that public authorities must seek to maintain and enhance biodiversity so far as consistent with the proper exercise of their functions and in doing so promote the resilience of ecosystems	<ul style="list-style-type: none"> • All public authorities • Ideally, this will be considered at the earliest opportunity in a project to ensure it can be considered at the outset of any new active travel development, rather than risking costly changes to designs at later stages • Welsh Government has produced guidance on how this can be considered as part of scheme development
Flood and Water Management Act (2010)	This act aims to reduce and mitigate the risk of flooding and erosion	Under Schedule 3, local authorities must include sustainable drainage systems (if the development is 100 square metres or more) The Statutory Standards, which accompany the legislation, set out the requirements for the design, construction, operation and maintenance of sustainable drainage systems. Further detail on how sustainable drainage can be incorporated into active travel schemes are provided within chapter 14	<ul style="list-style-type: none"> • Anyone developing an active travel route or related facility of more than 100sqm
Learner Travel (Wales) Measure 2008 (LTM)	This sets out the specifications for which local authorities must provide home to school transport	Sets out a duty on Welsh Government and local authorities to promote sustainable modes of travel when exercising duties under the Measure	<ul style="list-style-type: none"> • Local authority educational, planning and transportation/highway departments

Act	Overview	Relationship to active travel implementation	Who is this relevant to?
Socio-economic duty	The duty aims to deliver better outcomes for those who experience socio-economic disadvantage	There is a direct correlation between socio-economic disadvantage and transport poverty. High quality active travel infrastructure improves access to local services and offers a low cost and transport option	Public bodies listed in the regulations have a statutory duty to comply, but all public bodies shall consider the duty when making strategic decisions
Transport (Wales) Act 2006	This act sets out the duties of the Welsh Ministers in developing transport policies within Wales	Provides the basis under which transport strategies/policies and plans are developed within Wales	<ul style="list-style-type: none"> • Welsh Ministers • Local transport authorities

3.9 Other key relating strategies, frameworks and charters

3.9.1 The following table outlines policies, strategies and frameworks that support or should be considered when undertaking duties in line with the act. This list is not exhaustive and care should be taken to consider additional relevant legislation and strategies, informed by specific circumstances.

Table 3.3 – Other supporting strategies relating to active travel implementation

Strategy	Overview	Relationship to active travel implementation	Who is this relevant to?
Clean Air Plan for Wales: Healthy Air, Healthy Wales	Plan aims to improve air quality and reduce impact of pollution health, biodiversity, the natural environment and our economy	Uptake in active modes can contribute to addressing a number of the aims within this plan	<ul style="list-style-type: none"> • Those looking to justify and implement active travel improvements
Low Carbon Delivery Plans	Set out how the Welsh Government will meet its legal commitment to achieve net zero emissions by 2050 through actions taken for the interim carbon budgets	Mode shift to active travel reduces carbon emissions from transport	<ul style="list-style-type: none"> • Welsh Ministers
Action on Disability: The Right to Independent Living	A Framework and Action Plan setting out commitments and actions to remove barriers that stop disabled people from fulfilling their potential and achieving their ambitions based on the Social Model of Disability	Sets out key commitments on working with disabled people to address barriers to inclusion including in the transport sector	<ul style="list-style-type: none"> • Welsh Government commitments; other public service providers are encouraged to follow the commitments in the framework

Strategy	Overview	Relationship to active travel implementation	Who is this relevant to?
Local Well-being Plans	These set out how the Public Services Boards in each area will meet their responsibilities under the Well-being of Future Generations (Wales) Act	As this is directly linked to the Well-being of Future Generations Act, in the majority of cases, active travel can contribute towards achieving Local Well-being Objectives	<ul style="list-style-type: none"> • All public service bodies involved in implementing active travel
Healthy Weight, Healthy Wales	The obesity strategy for Wales – sets out actions in four themes	Active travel supports two themes: Healthy environment and Healthy setting; reducing obesity through building physical activity into everyday journeys	<ul style="list-style-type: none"> • Welsh Ministers • Public Health Wales • Local authorities • NHS Wales PSBs



Chapter 4: Network principles and requirements

To meet the duties of the act, local authorities must produce maps of existing active travel routes and related facilities in a local authority's area and of the future and improved active travel routes and related facilities needed to create integrated networks for active travel. These area maps are to be submitted to the Welsh Ministers for approval within a prescribed timetable. Local authorities also have a duty to make year on year improvements to their active travel routes and related facilities.



4.1 Introduction

- 4.1.1 As introduced in chapter 1, the purpose of the act is to increase the number of people in Wales who walk and cycle for everyday purposeful journeys.
- 4.1.2 For this vision to be achieved, the act sets out a process for local authorities to follow to create networks of active travel routes. The term network in relation to active travel means routes which join up so that people can travel in a continuous and safe way between their origin and destination.
- 4.1.3 This chapter deals with the basic principles and processes required for developing the active travel network. The chapter also refers to the active travel network map (ATNM) in its function as a tool for planning the network as required by the act. Further technical detail on actions required to deliver the network are provided in chapter 10.

4.2 Who the network is for

- 4.2.1 In conceptualising and planning the active travel network, local authorities should keep in mind the users who will benefit from it. Chapter 9 goes in to more detail regarding the specific needs of users in relation to infrastructure design. This section deals with the general principles of network development; the type of journey the network is designed to serve, typical distances walkers and cyclists can be expected to travel, and other considerations.
- 4.2.2 The active travel network is designed to serve everyday journeys. These are also known as utility journeys – trips with a purpose rather than purely for leisure. Examples of destinations which can be considered to form an everyday or utility journey include; school or other educational establishments, local shops, employment sites, healthcare facilities, and other destinations people travel to for a purpose.
- 4.2.3 Table 4.1 provides a guide for network development in relation to reasonable distances that would be travelled by each respective mode.
- 4.2.4 Table 4.1 is not descriptive of all active users and travel distances may be dependent upon a number of factors such as journey purpose, topography or suitability of route.

Table 4.1 – Typical distance range for each mode of active travel

Mode	Less than 1 mile	Up to 2 miles	Up to 3 miles	Up to 4 miles	Up to 5 miles	Up to 7.5 miles	Up to 15 miles
	●	●	●	●	●	●	●
	●	●	●	●	●	●	●
e- 	●	●	●	●	●	●	●

Colour	Average active user likelihood
●	Many users likely to travel this distance for utility journeys
●	Some users likely to travel this distance for utility journeys
●	Few or no users likely to travel this distance for utility journeys

- 4.2.5 Two out of every three journeys are less than five miles in length¹ – an achievable distance to cycle for most people, with many shorter journeys also suitable for walking. For school children the opportunities are even greater: three quarters of children live within a 15-minute cycle ride of a secondary school, while more than 90% live within a 15-minute walk of a primary school.
- 4.2.6 Perceived danger from road traffic is an often quoted key barrier preventing more people taking up walking and cycling. The perceived safety of a journey will be determined by the whole route, with junctions in particular often being a reason for the entire journey being considered unviable for walking or cycling.
- 4.2.7 Local authorities should seek to provide infrastructure that separates walkers and cyclists from motor vehicles where traffic volumes and speeds exceed the values for a shared carriageway. Clearly, not all residential areas will be able to accommodate separate routes. In this case, the concept of the basic network should inform active travel network planning; quieter streets where the speed and volume of traffic allows active travellers to share space with motor vehicles without fear of collision. A full definition of the basic network is given in chapter 10. Routes containing elements of the basic network should be included on the ATNM and may be eligible for Welsh Government funding. The extent of the basic network and the effectiveness of its design and delivery will be a major factor in attracting new walkers and cyclists.
- 4.2.8 As a general principle, the network should cater for children to travel independently, as a walker or cyclist (as defined within the act), from the age at which they start secondary school.
- 4.2.9 The active travel network is important to the many disabled people who cannot otherwise travel independently. Their needs should be considered at every stage of the design and development of the network as outlined in chapter 9.

¹ <https://www.sustrans.org.uk/our-blog/research/all-themes/all-key-walking-and-cycling-statistics-for-the-uk/>

- 4.2.10 New active travellers are unlikely to be familiar with the location or direction of existing infrastructure especially if it has an alignment away from the highway. Clear signage as well as promotion materials and activities should therefore be an integral part of the development of the network.

4.3 The active travel network map

- 4.3.1 The first of the duties under the act, outlined within chapter 2, relates to the requirement for local authorities to map existing and plan future active travel routes. Local Authorities need to produce active travel network maps (ATNMs) showing these routes and covering all designated localities within their areas (see 4.4 below).
- 4.3.2 The active travel network map (ATNM) as a network planning tool enables a local authority to develop and maintain a strategic plan of all routes, whether a route currently exists and meets the required active travel design standards (an Existing Route) or not (a Future Route).

4.4 Designated localities

- 4.4.1 Under section 2(4) of the act the Welsh Ministers are empowered to designate localities in a Direction. The duty to map routes is specific to those designated localities. This is to ensure that there are plans in place for the creation of active travel networks in all the most populous areas in each authority. It does however not limit an authority's ability to develop network maps for other localities, where there is demand for active travel routes and a high potential for their use. A schedule of designated localities by local authority area, can be found in Appendix B on page 291.
- 4.4.2 Duties relating to promotion of active travel and making provision for walkers and cyclists in exercise of certain functions apply to the whole of the local authority area (not only designated localities). The duty to improve provision for walkers and cyclists therefore applies to all developments and highway improvements both within and outside of the designated localities.
- 4.4.3 Connecting outlying communities to a nearby designated locality, and linking localities to each other and to key destinations such as workplaces and transport hubs where the distance is suitable, is a core element of network planning. Routes serving these purposes should therefore be included on the ATNM even though they sit outside a designated locality. Funding for such routes can be applied for (provided there is clear evidence of potential for modal shift), though the focus of the networks should be within the designated localities which are likely to have a higher impact.
- 4.4.4 Local authorities shall liaise with neighbouring authorities to map active travel routes where there is demand to travel between authority areas. Certain authorities may also choose to map areas in England and work with authorities there to ensure an effective network (for example, integrating with relevant English Local Authorities' Cycling and Walking Investment Plans).

4.5 Rurality

- 4.5.1 The isolated nature of communities, sparsity of services and the increased length of journeys will often mean that enabling active travel in rural areas requires a different approach to that for larger towns and cities. Such longer journeys may be more achievable by a combination of active travel and public transport, where this is available. In rural locations, local authorities may therefore want to prioritise walking and cycling links to public transport services (bus stops and rail stations).
- 4.5.2 E-cycles are becoming increasingly popular and affordable, enabling cycling for longer journeys or over more challenging hilly terrain and for wider population groups. Other than charging facilities, e-cycles require no additional infrastructure compared to other types of cycles. Local authorities may want to emphasise the potential of e-cycles in their promotion of active travel, in particular in rural or hilly areas.
- 4.5.3 Adopting a more flexible approach to mapping routes that extend outside the designated localities may also be useful where the settlement is relatively close to a larger urban centre in which many of the services that attract local trips are located. The likely impact of these routes in terms of increased active travel journeys should be considered in the prioritisation process.

4.6 Mapping of routes and related facilities

- 4.6.1 To ensure consistency across Wales, the ATNM shall be created using the Welsh Government provided mapping system, Data Map Wales.
- 4.6.2 The primary purpose of showing the existing routes and related facilities on the Map is to provide a visual representation of current routes that meet active travel standards and can be used for everyday journeys, as well as constraints where routes fall short of the guidance.
- 4.6.3 The Future Routes layer of the ATNM shows where routes are planned for improvement to bring them up to the standards, as well as entirely new routes that the local authority proposes to create in the future.
- 4.6.4 The ATNM must include existing routes suitable for walking and/or cycling as well as future proposed routes for walking and/or cycling. Each route should be supported with specific details that make up a schedule – as well as, if applicable, any associated statements which set out limitations of the routes. Data Map Wales includes a process for capturing the route information, schedules and associated statements. Route suitability is determined using a standard set of criteria, which is introduced in chapter 10.
- 4.6.5 Publicly available related facilities, such as cycle parking and toilets (as defined within the act) should also be shown on the ATNM, with caveats where access is not universal.
- 4.6.6 In certain contexts, local authorities may wish to designate areas of high pedestrian footfall as prestige walking zones within town or city centres – with an aim for all walking routes covered within the area to meet active travel standards. Similarly, low

traffic neighbourhoods (described in chapter 11) can be designated across a wider area. Future development of Data Map Wales will allow these zones to be identified on the ATNM, whether existing or future.

- 4.6.7 Any physical barriers to active travel, such as a level crossing or steep gradients, should also be shown on the ATNM. Routes and facilities not covered under the act and that do not meet active travel standards (e.g. an unsurfaced Public Right of Way) can be shown, but their presentation must be differentiated from the active travel network.
- 4.6.8 Further detail about the mapping of routes and related facilities (including advice on where statements are applicable and preparation of the map) is provided within chapter 10.
- 4.6.9 Welsh Government will offer a number of training opportunities to those involved in planning and delivering active travel networks during each map submission cycle. This will include training in using the mapping system as well as training in implementing this planning and design guidance.

4.7 Prioritisation and network coverage

- 4.7.1 Prioritisation is an essential element in the delivery of the Active Travel Act. The ATNMs are intended to show how the network will develop over a fifteen year period. Clearly not all routes can be developed at the same time. Similarly, not all routes will have the same impact on increasing the number of active travellers or achieving other local or national goals that can be facilitated by improving active travel infrastructure. It is therefore important that local authorities have a clear plan for the prioritisation of routes to help determine the order in which routes should be developed or constructed and to demonstrate to the public and stakeholders the long term nature of the development of the network during the engagement and consultation process.
- 4.7.2 The factors used in assessing priorities can be determined locally based on addressing local needs and issues and taking advantage of opportunities such as new development or highway improvement plans. However, it should be noted that the extent to which priority has been given to routes that will maximise an increase in active travel will be a consideration for Welsh Ministers when allocating funding, section 10.15 provides detailed advice on prioritisation.
- 4.7.3 The construction of a comprehensive network may take many years. Its completion will be achieved through:
- direct investment in new and improved routes using funding specifically allocated to active travel
 - the incremental integration of enhanced routes and facilities for walking and cycling in the design of highway improvements and new highway schemes as required by the act
 - any new or improved routes that are provided by new developments such as new housing, commercial, education and industrial sites (including any off-site highway improvement works within the development)

- 4.7.4 A well-developed and regularly updated ATNM will enable enhancements associated with new developments, highway improvements and traffic management schemes to be properly integrated into the delivery of future routes. This will significantly reduce the level of dedicated active travel funding required and possibly reduce the timeframes for completion of a comprehensive network.
- 4.7.5 Welsh Government expects to see incremental improvement to the density of networks each time an ATNM is submitted for approval by Welsh Ministers, with the aim of working towards a comprehensive network for each designated locality.
- 4.7.6 A comprehensive network is defined as where there is a distance of no greater than 250m between adjacent routes (either existing or future). This network coverage is known as 'mesh density' and is further explained in chapter 10.
- 4.7.7 These routes must connect all key destinations. This includes all current and planned schools within the designated localities and these must be included in the 2021 iteration of the ATNM. Where a school within a locality's catchment area covers another designated locality within a reasonable walking or cycling distance (refer to table 4.1), routes should be mapped between these localities.
- 4.7.8 Chapter 10 provides detailed information about the prioritisation process and information on factors that can help within this process, including further explanation of the 'mesh-density' principles.

4.8 Map submission

- 4.8.1 The act requires local authorities to submit their ATNM to Welsh Ministers no later than three years after the date on which their ATNM was last approved, though the act gives Welsh Ministers the power to specify a different time period by issuing a direction. This may be to alter the submission date for all local authorities, or for individual authorities. It may be earlier than the three year period where local circumstances have changed and there is an urgent need for an alteration. Such a direction would normally be made at the request of the local authority and specify the area to be covered in the review and the date by which the next full review of the ATNM must be submitted.
- 4.8.2 Local authorities have a duty to consult on the ATNM and shall submit a report of the engagement and consultation that they have undertaken in producing the Map alongside it, using the proforma supplied in Appendix D. Principles for effective consultation and engagement are described within chapter 5.
- 4.8.3 When local authorities are ready to submit their ATNM and consultation report, they should notify Welsh Government by email and use the Data Map Wales system to generate and save a snapshot of their ATNM. Welsh Government will review the submitted maps directly on Data Map Wales.
- 4.8.4 It is important to note that routes not identified on a Map approved by Welsh Ministers will not be eligible for Welsh Government active travel funding.

4.9 Approval

- 4.9.1 In considering whether to approve the ATNM and supporting documents the Welsh Ministers are required to consider:
- whether the process set out in this guidance has been followed
 - whether appropriate consultation, in line with this guidance, has been conducted (further details in chapters 5 and chapter 8)
 - whether format of the existing routes and future routes layers follows this guidance
 - whether any statements provide suitable explanation for why routes that do not meet the required design standard are included as existing routes (if applicable)
- 4.9.2 They will also consider:
- whether the submitted ATMNs are ambitious enough to meet the objectives of the act
 - the coherence of the network for serving everyday journeys by joining up destinations, rather than the quality of individual routes
- 4.9.3 The Welsh Ministers may require local authorities to resubmit their ATNM if the authority has not consulted appropriately; has not had regard to this guidance as to the consultation and preparation of the map, including what should be shown on the map and its format; and/or if the explanation of the nature of the routes is insufficient. In such an event, the local authority will be provided with an explanation and asked to make appropriate amendments, before resubmitting by a date prescribed by the Welsh Ministers.
- 4.9.4 Welsh Ministers may decide to approve only the future routes or only the existing routes on a local authority's ATMN, where they consider that only one set of routes has met the requirements set out in this guidance. Only the approved set of routes may be eligible for funding. Where only one set of routes has been approved, the local authority must make appropriate amendments to the part of the ATNM that was not approved before resubmitting in accord with section 4.8.
- 4.9.5 Welsh Government funding for active travel will only be granted for improvement of existing routes and construction of future routes that appear on the local authority's approved active travel network map. In allocating funding, Welsh Ministers will take into account how local authorities have prioritised the improvement and expansion of their network to maximise an increase in active travel.

4.10 Publishing the map

- 4.10.1 The ATNM is important both for members of the public who are, or may wish to, undertake active travel journeys, but also for planning purposes for developers, other

local authority departments and other third party partners who may want to use active travel route data for their services. The completed ATNM must therefore be publicly available as soon as reasonably practical after the Welsh Ministers have agreed the draft sent to them for approval. Local authorities are encouraged to bring the ATNM to the attention of the local population and relevant bodies in an appropriate way for their area. Further suggestions for methods associated with promotion are provided within chapter 5.

4.10.2 Local authorities must:

- publish the ATNM and any associated documents (e.g. statements and the list of prioritised routes) in a manner they consider appropriate
- send a free copy to such persons they consider appropriate
- supply a copy or a part of it, free of charge or at the cost of providing the copy, to any person who requests a copy
- make a copy available at all reasonable hours at places they consider appropriate
- bring to the attention of the public where copies are available

4.10.3 To meet the requirements for publication local authorities shall:

- make electronic copies of the ATNM available on their website and ensure these are as accessible as possible
- produce versions in any other languages considered appropriate as well as the versions in Welsh and English
- make large print and Braille tactile maps available on request

4.11 Continuous improvement

4.11.1 Local authorities have a duty to make year on year improvements to their active travel routes and related facilities. Under this duty, local authorities are required to build new active travel infrastructure, as well as improve the existing infrastructure.

4.11.2 There are two ways that local authorities will demonstrate to Welsh Government that they have delivered this duty:

- through the revision of the active travel network map. At the three-year review point, there should be a measurable difference between the number and length of Existing Routes on any previous map and the new one
- through their annual reports in which they set out the actions taken and the costs they have incurred in developing their active travel networks. Chapter 6 of this guidance gives more information on reporting and monitoring requirements including how DataMapWales assists with meeting these

4.12 Review (and partial review) of the map

- 4.12.1 The purpose of the three-year review cycle of the ATNM is to enable continuous refinement and improvement of the network and to take account of changes, such as in land use or environmental factors. Reviews also contribute towards demonstrating to Welsh Government that continuous improvements are being undertaken in line with the duties of the act. The review process will be a combination of adding new future routes and changing the designation of future routes to existing routes as the infrastructure is built or improved. The review will also involve the removal of statements as improvements to existing routes are completed.
- 4.12.2 There may be circumstances in which local authorities wish to make a partial revision of their map earlier than required by Welsh Ministers. For example, where an unanticipated development is taking place and the authority wishes to ensure that it can be connected to the active travel network. In these circumstances the local authority may request that Welsh Ministers direct them to review their map by an earlier date, specifying the area which they wish to review. Welsh Ministers will consider approving a partial revision subject to evidence of appropriate engagement and consultation having taken place. Details of engagement requirements for a partial review are contained within chapter 8.
- 4.12.3 At least one public consultation event should be held in each of the settlements affected by the revision.
- 4.12.4 The consultation process should run for a minimum of 12 weeks.
- 4.12.5 Submitting a partial or interim review will not affect the three-year timetable for submitting the authority's full review of the ATNM.

4.13 Planning status of the map

- 4.13.1 ATNMs should be used to inform the preparation and review of local development Plans and strategic development plans. Planning Policy Wales requires ATNMs to inform site allocations, with priority given to sites that can be connected to existing and future active travel routes. The ATNM, therefore, has an important role in the planning system to help ensure new development is linked to the wider active travel network.
- 4.13.2 Active travel network maps are not definitive maps, in the way that Public Rights of Way maps are, and in general the location of future routes can be indicative. However, for active travel routes being incorporated in new development, the exact route should be considered as part of the overall design for a scheme and be informed by a wider site and context analysis. This is in the spirit of walking and cycling being the priority in the design of new development, as required by the sustainable transport hierarchy in Planning Policy Wales. Once a route has been built, its exact location should be reflected in an updated version of the ATNM.



Chapter 5: Consultation, engagement and promotion

This chapter summarises the duty arising from the act to consult with members of the public and key stakeholders when local authorities are updating their active travel network maps.

It also provides a summary of what is meant by the terms engagement, consultation and promotion in relation to the act. Full details on implementation of these principles is provided in chapter 8.

The act requires local authorities to consult with members of the public and key stakeholders when local authorities are updating their active travel network maps. It also requires local authorities to engage with all persons who have requested that they be consulted and places a duty on local authorities to promote active travel.

5.1 The duty to consult

- 5.1.1 The act requires local authorities to engage with all persons who have requested that they be consulted.
- 5.1.2 Local authorities shall advertise in an open and accessible way how members of the public should register their interest in being involved, including telling people the timescales when ATNM engagement is likely to be running.
- 5.1.3 In addition to members of the public, local authorities shall involve the following organisations, as a minimum, in the engagement and consultation process
- delivery partners, including: other departments within the local authority, adjoining local authorities, community/town councils, One Voice Wales, National Park authorities (where relevant), Natural Resources Wales, Transport for Wales, Canal and River Trust, Welsh Water Dŵr Cymru, Severn Trent Water and Dee Valley Water, Network Rail, the Crown Estate, National Trust, Woodland Trust and the Welsh Government and its trunk road agents
 - elected members
 - other interested parties, including; the authority's active travel liaison group (where present), any Local Access Forum established for the area or any part of it, walking and cycling groups, transport campaign groups, local health promotion groups, local Chambers of Commerce, large employers, trade unions
 - children and young people, local authorities should engage with young people both through school and other educational establishments but also through youth groups and other forums where young people meet

- people with protected characteristics, the Equality Act 2010 requires local authorities to specifically seek to engage with individuals and groups representing people with protected characteristics.

5.1.4 Local authorities should consider the format of both the ATNM and the consultation to best meet this duty. For example, by producing an easy read version of the consultation. In particular, local authorities should consider how they enable blind and partially sighted people to take part in the consultation as, by its nature, the map will be a visual representation. Alternatives which will make what is set out in the map clear to anyone who cannot access the map should also be planned for as part of the consultation. In practice, this will often mean an oral explanation of the plans. Some local authorities have also successfully employed tactile representations of planned developments as an alternative to two dimensional maps. It is recommended that local authorities engage with the [Wales Council of the Blind](#), who have access to an extensive network of people who could be invited to participate in the consultations. An information sheet on engaging blind and partially sighted people in active travel network planning and design can be found on the [Welsh Government's website](#).

5.2 Engagement and consultation principles

5.2.1 In addition to the duty to consult whilst local authorities are preparing their active travel network maps, they are also required by other pieces of legislation, introduced in chapter 3, to consult when developing specific proposals for new active travel routes. Notably, two of the five ways of working that make up the sustainable development principle defined by the Well-Being of Future Generations (Wales) Act 2015, relate to:

- involving a diversity of the population in the decisions that affect them
- working with others in a collaborative way to find shared sustainable solutions

5.2.2 This section outlines the principles of engagement and consultation when conducting duties required under the act. Detailed information on applying these principles is provided in chapter 8. For clarity, the difference between engagement and consultation in the context of this document can be summarised as;

- engagement refers to a range of activities undertaken to involve the community in delivery of the duties under the Active Travel Act and development of active travel schemes
- consultation refers to the formal processes required when developing the map and route or facility improvements

Engagement

5.2.3 Routes and networks that have been developed with the involvement of local communities, stakeholder groups and current and potential active travellers are much more likely to be used and will be more easily implemented than those imposed on communities with little or no pre-engagement. Engagement events and materials also provide an opportunity to directly promote active travel.

- 5.2.4 Successful engagement on network planning and scheme design relies on the following principles being met:
- accessible – with regard to location, format, style, language, timing
 - broad – opportunity to get involved for everybody who is directly or indirectly affected, including potential users
 - clear parameters – clarity of scope and limitations of what is being discussed
 - suitable tools – use of consultation and engagement tools
- 5.2.5 When developing their engagement plans, lead officers should liaise with colleagues in other departments who may have expertise or are part of networks representing people with protected characteristics.
- 5.2.6 Local authorities should make every effort to engage groups who are not active travellers now. This could be through combining engagement on the ATNM with other local community events, or holding stand-alone events at schools, large employers, supermarkets, local shopping areas or other possible trip-generators. Promotion of online engagement exercises can also be targeted with an aim to engage with those who do not currently walk or cycle for utility journeys.

Figure 5.1 – Community engagement event outside a school



- 5.2.7 Explaining to people the practical considerations of the time and resources required to deliver the network will help to manage expectations. Seeking their views to help inform timescales for delivery will help the public to appreciate the long-term nature of the planning and development of the network and ensure that the proposed network addresses local issues and ambitions.
- 5.2.8 Engagement shall therefore take place at the earliest stage and should be an important part of the network planning process, particularly when identifying future routes. Local authorities should keep a record of engagement undertaken throughout the ATNM review process and development of individual schemes.

5.2.9 Local authorities should develop a overarching consultation and engagement strategy to set the principles and priorities for how they will undertake these activities. Involving stakeholder groups in the drafting of this strategy, particularly organisations representing disabled people, will mean that subsequent individual scheme consultation can follow the pre-agreed process.

Consultation

5.2.10 Prior to the submission of the ATNM to Welsh Government, there must be a formal public consultation which should run for a minimum of 12 weeks.

5.2.11 The effectiveness of the local authority's consultation is an important factor in Welsh Ministers' determination of whether to approve an Active Travel Network Map. The draft ATNM shall be accompanied by a report of the engagement and consultation process. Evidence of effective early engagement is as much of a consideration for Welsh Ministers in their assessment of the ATNM as the level of involvement in the formal consultation. A copy of the pro-forma for reporting on the engagement and consultation process is to be found in Appendix D.

5.2.12 Consultation on the ATNM does not negate any statutory requirements for consultation and engagement that may be required as part of an individual scheme. Chapter 8 sets out the procedure that should be followed.

Key considerations

5.2.13 Local authorities need to consider the appropriate level of detail to be provided when consulting with the public. Technical engineering drawings are likely to provide more detail than is necessary and may prove inaccessible to the lay person. Any schemes should be clearly marked and explained, with available technical details provided in addition to more illustrative plans, rather than forming the basis of consultation materials.

5.2.14 Different types of consultation methods will be accessible for different people; whilst a vibrant on-street consultation event in the centre of town may engage and excite some people this could be intimidating and exclusionary to others. It is therefore important to make use of a range of different types of consultation including face to face engagement and online consultation which may include use of social media.

5.2.15 Increasing active travel to school is a key objective of Welsh Government. Involving schools in identifying and planning routes that could be used by students for their daily commute is therefore a valuable form of engagement. Dedicated programmes encouraging active travel to school will be of assistance in engaging school students in the process. Suggested delivery methods are included within chapter 8.

5.2.16 Local authorities should liaise with other stakeholder organisations and agencies to identify opportunities to collaborate on shared engagement events to help minimise the risk of consultation fatigue.

5.2.17 It is good practice and therefore recommended that local authorities capture the satisfaction levels of people who have taken part in the engagement and consultation exercises. This helps take an inclusive approach and identify if there are accessibility short-comes that need to be addressed.

5.3 Promotion

- 5.3.1 Local authorities are under a duty to exercise their functions under the act in a manner designed to promote active travel journeys and secure new and improve existing active travel routes and related facilities.
- 5.3.2 Local authorities should seek to work together across departments to promote active travel. This includes working together across local and regional boundaries. Authorities should also work with other relevant agencies and organisations such as schools, health boards, workplaces, transport operators, interest groups, disability forums and voluntary organisations.
- 5.3.3 Welsh Government will be developing additional support to help local authorities meet their duty to promote active travel. A set of practical resources and guidance will be produced and made available in the form of a toolkit. The toolkit will be developed in 2021 and will draw on existing good practice for promotion of walking and cycling using evidence based behaviour change techniques. A summary of suggestions for how local authorities, and other bodies, can promote active travel are included in figure 5.2.
- 5.3.4 Local authorities must report to the Welsh Ministers on how they have delivered functions under the act in a manner that promotes active travel journeys in each financial year. This report shall detail activity to promote active travel undertaken by any departments in the local authority and should include activities undertaken on health promotion, or environmental protection as well as transport. The report does not need to set out the detail of all projects and can be a summary (unless the local authority wishes to provide more detail as part of meeting local active travel policy objectives). A template is included as Appendix F and Welsh Government will reissue these ahead of the report due date, which is usually 30 September each year.
- 5.3.5 Promotion of results from monitoring measures can help in justifying future improvements to the active travel network. The duties for monitoring under the act are included within chapter 6, with suggested methods to undertake this within chapter 16.
- 5.3.6 Publication and promotion of the ATNM (or tailored maps derived from the ATNM) can also help to promote the availability of routes and related facilities within an area. An example of such a map is available in Appendix C.

Figure 5.2 – Suggested ways of promoting active travel through a range of settings



LLWYBR YSTWYTH
YSTWYTH TRAIL



81

82



81

82



Chapter 6: Monitoring and reporting

The act requires local authorities to submit a report to the Welsh Government on the extent to which walkers and cyclists make active travel journeys and set out what actions have been taken to promote active travel, each time they submit their network map. They also need to report annually on the costs they have incurred making improvements to their active travel network and the activities they have undertaken to promote active travel.

6.1 Introduction

- 6.1.1 Monitoring and reporting is key in evaluating the impact of improvements, justifying future improvements and providing evidence to support continuous development of good practice.
- 6.1.2 This chapter summarises the reporting requirements of the legislation and introduces the importance of taking a strategic approach to having a monitoring framework. Chapter 16 provides further details of how local authorities should meet these requirements.

6.2 Reporting duties under the Active Travel (Wales) Act

- 6.2.1 The act places reporting duties on both Welsh Ministers and local authorities.
- 6.2.2 Welsh Ministers are required to make annual reports on the extent to which walkers and cyclists make active travel journeys.
- 6.2.3 The act requires that each time the local authority submits its ATNM, which is usually every three years, the authority must present a report to Welsh Government showing how the level of use of active travel routes and related facilities in the local authority's area has changed since the last submission.
- 6.2.4 The act also requires local authorities to submit an annual report specifying the costs incurred in making year on year improvements to active travel routes and facilities in the most recent financial year. The annual report must also set out what actions local authorities have taken to promote active travel. Annual reports shall be submitted by 30th September each year. Appendix F provides the current templates for local authorities to use for these annual and triennial reports. These may be subject to change and will be reissued accordingly.
- 6.2.5 Information on how to gather the data required for the reports can be found in chapter 16 (Monitoring and Evaluation).
- 6.2.6 Local authorities shall publish the reports they submit to the Welsh Ministers on their website so members of the public can view the reports.

6.3 A strategic approach

- 6.3.1 As introduced in section 6.2, the act places specific duties on local authorities and Welsh Government for annual and triennial reporting. To comply with this duty local authorities shall undertake detailed monitoring of individual active travel schemes. Recommendations for how to go about this are included in chapter 16.
- 6.3.2 It is recommended that a local monitoring and evaluation framework is put in place by each authority so that a strategic approach, which sets the context for individual scheme level monitoring, is established. This framework would usefully refer to a wider range of data e.g. road safety reports, accident hotspots, air quality monitoring reports etc. so that trends are tracked which are useful to inform decisions related to active travel.
- 6.3.3 Welsh Government will be devising a monitoring and evaluation framework to monitor progress towards the commitments in the new transport strategy Llwybr Newydd. Local authorities may find it useful to refer to this when preparing their local active travel evaluation frameworks.





Part 2

Planning and design for active travel in Wales

Chapter 7: Introduction to planning and design

Part 2 of the guidance sets out the approaches for planning and designing networks and routes for walking and cycling, following on from Part 1 which dealt with the policy background and formal processes for complying with the Active Travel (Wales) Act 2013.

Key considerations include:

- highway design and the Highways Act
- implementation of the act and guidance for trunk road and local road schemes
- status of the design elements provided in this guidance and other related standards

7.1 Planning and design for active travel in Wales

7.1.1 Whilst this part of the document relates mainly to the technical elements involved in designing infrastructure to enable and support active journeys, it must be emphasised that for routes and infrastructure to achieve the greatest potential for modal shift, infrastructure changes must be accompanied by effective behavioural measures.

7.1.2 Part 2 provides design details for making improvements to walking and cycling infrastructure. This part of the guidance helps stakeholders meet key duties under the act, including:

- making continuous improvements to active travel infrastructure
- enhancing provision for walkers and cyclists when constructing, improving or maintaining highways
- having regard to needs of walkers and cyclists when putting in place traffic management arrangements

7.2 Status of the Active Travel Act guidance

7.2.1 This guidance is issued using the powers of the Welsh Ministers to give guidance under sections 2(6), 2(9), 3(4), 4(5) and 7(2) of the Active Travel Act.

7.2.2 The document is published by the Welsh Government for use throughout Wales and the contents must be considered when designing and maintaining active travel routes and related facilities, enhancing provision for walkers and cyclists as part of other highway schemes (including planned highway maintenance works), or when considering the needs of walkers and cyclists as part of new developments, traffic management and road safety schemes.

7.3 Highway design and the active travel act

- 7.3.1 Opportunities to enhance the provision for active travel must be taken whenever works associated with the highway are carried out, including new construction, maintenance or any improvements.
- 7.3.2 Active travel modes shall be integral to planning and design from the outset, rather than being seen as an 'add-on' once the needs of motor traffic have been considered. Designers of new highways should consider the five attributes of good walking and cycling routes given in earlier chapters – Coherent, Direct, Safe, Comfortable and Attractive – and find ways to meet them as part of the scheme.
- 7.3.3 The Active Travel (Wales) Act stipulates that Welsh Ministers and each local authority must take reasonable steps to enhance the provision made for walkers and cyclists when they are exercising their functions under Parts III, IV, V, IX and XII of the Highways Act 1980 (creation, maintenance and improvement of highways, interference with highways and acquisition etc. of land), as far as it is practicable to do so.
- 7.3.4 The Highways Act 1980 includes provisions on the creation, maintenance and improvement of highways. Active travel routes will mostly be highways in law (a highway being essentially a route over which the public has the right to pass and re-pass). The definition of a highway excludes permissive routes, where the landowner's consent to use of the route is required, though permissive routes may also be designated as active travel routes.
- 7.3.5 Table 7.1 summarises the provisions of the Highways Act 1980 that are affected by the Active Travel (Wales) Act.
- 7.3.6 Highway authorities have not always carried out these functions in a way that would be compatible with the aims of the 2013 act. Some newly-built highways and "improvement" schemes have failed to improve conditions for pedestrians and cyclists – and in some cases have made things worse.
- 7.3.7 When maintaining, improving or creating new highways, authorities shall treat walking and cycling with at least the same importance and consideration as motorised transport.
- 7.3.8 Schemes to build new or improved highways will have a primary objective, for example to reduce congestion or to provide access to a new area of development, but authorities must also give careful consideration to whether (and how) the scheme can add to the active travel network.
- 7.3.9 Within the Active Travel Act, authorities must always expressly include the objective of enhancing provision for walking and cycling; and translate this into specific and measurable outcomes; for example, making a suitable link from a residential area to a school. This will enable the emerging designs to be assessed against the stated objectives.

Table 7.1 – Function and requirements

Function being exercised under	Duties and powers	Requirements of the Active Travel Act
Part 3 of the Highways Act (1980) – Creation of Highways	Power to create new highways, footpaths and bridleways	The duty to enhance provision for active travellers when undertaking highway construction, maintenance or improvement is a fundamental component in the construction of active travel networks
Part 4 of the Highways Act (1980) – Maintenance of Highways	Duty to maintain highways. Power to adopt new public highways	Highways authorities must seek to enhance provision unless they can demonstrate good reason not to. The consideration of the needs of active travellers shall be an important consideration in all highways projects and feature in the earliest design considerations
Part 5 of the Highways Act (1980) – Improvement of Highways	Powers to generally improve highways, including constructing cycle tracks, traffic calming, refuges, bridges, subways etc.; duty to construct footways where necessary or desirable	<p>Local authorities should align their active travel and planned highway maintenance programmes, seeking opportunities to deliver active travel improvement when carrying out planned highway maintenance works</p> <p>The costs of enhancing walking and cycling facilities in new road schemes will need to be taken account of as part of individual schemes and planned for accordingly</p> <p>It may be reasonable not to include active travel provisions if they could not form part of a route that connects to an active travel destination or if the authority’s Active Travel Network Map includes a satisfactory alternative route that can be delivered more economically and within a similar timeframe</p> <p>However, that does not remove the need to ensure the changes in the highway enhance the safety of walkers and cyclists other than where the type of highway explicitly prohibits walkers and cyclists from its environs</p> <p>Highways projects in Wales must not make walking and cycling less convenient or safe</p> <p>Local authorities shall ensure they have an audit trail demonstrating how they have met this duty in each highway improvement project and where it has been determined that no active travel provisions are to be made then a justification for this decision should be provided</p>

Function being exercised under	Duties and powers	Requirements of the Active Travel Act
Part 9 of the Highways Act (1980) – Lawful and Unlawful Interference with Highways and Streets	Duty to protect the public’s right to use a highway, removal of obstructions, prevention of damage etc. Duty to remove snow and soil etc.	To meet their duty under the act, highway authorities must enhance provision for walkers and cyclists when permitting or enforcing against interference with highways, where practicable to do so For example, in controlling excavations of highways, local authorities should seek to enhance provision for walkers and cyclists when restoring the highway
Part 12 of the Highways Act (1980) – Acquisition, Vesting and Transfer of Land	Powers to acquire land to construct public highways	To meet their duty under the act highway authorities must enhance provision for walkers and cyclists when acquiring land for highway construction where practicable to do so For example, when acquiring land for the construction of a road, local authorities should also acquire land for the construction of active travel routes

Table 7.2 summarises the duties to have regard to the needs of walkers and cyclists when Welsh Ministers and local authorities are exercising their functions under:

- Parts 1, II, IV and VII of the Road Traffic Regulation Act 1984 (general and special traffic regulation, parking places and obstructions)
- Part 3 of the New Roads and Street Works Act 1991 (street works)
- Part 2 of the Traffic Management Act 2004 (network management by local traffic authorities)

Table 7.2 – Function and requirements (2)

Function being exercised under	Duties and powers	Requirements of the Active Travel Act
Part 1 of the Road Traffic Regulation Act 1984 – General Provisions for Traffic Regulation	Powers to make orders to regulate traffic – prohibition, restriction or regulation use by any type of traffic. Powers to make experimental traffic orders	<p>To meet their duties under this part of the act local authorities and the Welsh Ministers must have regard to the needs of walkers and cyclists in making traffic regulation orders prohibiting, restricting or regulating the use of a road including roads for use by walkers and cyclists</p> <p>For example, if local authorities or the Welsh Ministers make a traffic regulation order to close roads for an event they must consider the effect upon walkers and cyclists when deciding to make the order and take mitigating action in making the order such as putting suitable diversions in place</p> <p>When planning diversions, the needs of disabled users must be fully considered. Due consideration must also be given to the impact on new active travellers of any change from a segregated route to one that brings them into contact with motorised traffic</p>
Part 2 of the Road Traffic Regulation Act 1984 – Traffic Regulation in Special Cases	Powers to make traffic regulation orders during construction works or for other special reasons. Powers to regulate traffic on byways in National Parks	
Part 4 of the Road Traffic Regulation Act 1984 – Parking Places	Power to provide parking places for vehicles (of any class), both on and off street. Power to acquire land to create parking places	<p>To meet their duties under this part of the act, local authorities must have regard to the needs of walkers and cyclists in providing off-street parking, authorising on-street parking and loading bays and the acquisition of land for parking</p> <p>For example, local authorities should consider the needs of walkers and cyclists in authorising on-street parking particularly where it would have a negative effect upon on-road cycle routes. If local authorities wish to authorise on-street parking where there would be negative effects for walkers and cyclists, alternative provision to mitigate these effects must be considered</p>

Function being exercised under	Duties and powers	Requirements of the Active Travel Act
<p>Part 7 of the Road Traffic Regulation Act 1984 – Bollards and Other Obstructions</p>	<p>Power to erect bollards etc. to prevent unlawful vehicular access</p>	<p>In placing bollards or other obstructions to prevent access to vehicles local authorities must have regard to the needs of walkers and cyclists</p> <p>Local authorities must consider whether access for walkers and/or cyclists needs to be prohibited. If it does not, they must ensure that any obstructions are designed so that they do not prevent access for walkers and/or cyclists</p>
<p>Part 3 of the New Roads and Street Works Act 1991 – Street Works in England and Wales</p>	<p>Powers to control the placing and subsequent works to statutory undertakers' equipment, and the reinstatement of the highway</p>	<p>Part 3 of the New Roads and Street Works Act 1991 concerns street works. Local authorities must have regard to the needs of walkers and cyclists in:</p> <ul style="list-style-type: none"> • granting street works licences • giving directions as to the timing of street works • the placing of apparatus • restricting street works following substantial road works • exercising their duty to co-ordinate works and giving consent to place apparatus on a protected street <p>Local authorities must consider the effects that street works may have on walkers and cyclists when deciding whether to grant licenses and should seek to minimise any disruption for walkers and cyclists when giving any directions or placing any restrictions on street works. The supplementary guidance below provides detailed advice:</p> <p><u>114/20: supplementary guidance for the safety at street works and road works a code of practice 2013 GOV.WALES</u></p>
<p>Part 2 of the Traffic Management Act 2004 – Network management by local traffic authorities and strategic highways companies</p>	<p>Duties in relation to network management by local authorities (which includes the road network used by pedestrians and cyclists)</p>	<p>Part 2 of the Traffic Management Act 2004 concerns network management by local traffic authorities. Under the Traffic Management Act 2004 local authorities are under a duty to manage their road network</p> <p>This duty requires local authorities to secure the expeditious movement of all road users, including walkers and cyclists. Local authorities must also ensure that measures to secure the expeditious movement of traffic are safe for all road users. To meet their duty under the act, local authorities must have regard to the needs of walkers and cyclists in setting priorities and making decisions about how to secure the expeditious movement of all traffic, motorised and otherwise</p>

- 7.3.10 Section 108(1)(s) and (2A) of the Transport Act 2000 requires local authorities to develop local transport plans. The Active Travel Act stipulates that local authorities must have regard to their Active Travel Network Map when updating local transport plans.
- 7.3.11 This duty was also modified by the Transport Act 2006, which requires local authorities to have regard to the Wales Transport Strategy when preparing their local transport plans. These plans must be approved by the Welsh Ministers, as do the active travel network maps.

7.4 Trunk roads

- 7.4.1 The requirements of tables 7.1 and 7.2 also apply to trunk roads.
- 7.4.2 The Welsh Transport Appraisal Guidance (WelTAG) represents best practice for the identification, development, appraisal and evaluation of transport interventions in Wales. The WelTAG process must be applied to all transport projects funded in part or in full by the Welsh Government, including improvements to the trunk road network. The act and this guidance takes precedence over the WelTAG process and so must be considered as part of any transport appraisal from the initial stage.
- 7.4.3 The need, nature and extent of any improvement to a trunk road must be determined by application of the WelTAG process. The WelTAG process will also help establish the nature and extent of active travel provision and promotion to be incorporated in the improvement subject to compliance with the Active Travel Act and the Welsh Government's policy and strategy for active travel.
- 7.4.4 WelTAG engagement and consultation exercises must include active travel stakeholders and representatives and local access forums together with all other delivery partners and groups.
- 7.4.5 Consideration must be given to the updating or re-running of WelTAG studies on trunk road improvement schemes, when greater than 3 years old.
- 7.4.6 The Welsh Government requires that the advice in this guidance must be considered when designing active travel routes along a trunk road or where active travel routes cross or join trunk roads.
- 7.4.7 Additional guidance directly relating to trunk roads is included in Procedure and Advice Guidance (PAG) 115/20 Active Travel and Trunk Road Improvement Schemes. This PAG reinforces the need for designers to understand Welsh Ministers' duties under the Active Travel Act and to design in accordance with the Active Travel Act guidance. It also stipulates promoting a cross boundary/cross organisational approach to delivery to maximise the impact of trunk road investment on active travel; and requires a robust peer reviewed and auditable approach to decision making.
- 7.4.8 All highway design on the trunk road network is undertaken in accordance with the Design Manual for Roads and Bridges (DMRB). This Active Travel Act guidance does not intend to supersede or conflict with any mandatory clauses within the DMRB, which remains the primary guidance for trunk road design. Key sections of the DMRB that are relevant to active travel include:

- GG 142 Walking, cycling and horse-riding assessment and review (WCHAR) – (which should also be used as part of the planning process)
 - GG143 Designing for Walking, Cycling and Horse-riding (which refers back to this document as the standard to be used within Wales)
- 7.4.9 To support cross boundary and organisational development of a scheme and identify active travel opportunities as early as possible, the following process should be included:
- draft WCHAR Assessment report to be presented to the Welsh Government at the end of WelTAG Stage 1
 - final WCHAR Assessment report to be presented to the Welsh Government for approval at the end of WelTAG Stage 2
- 7.4.10 This must include a full departure from guidance submission, endorsed by the Welsh Government's Chief Highway Engineer (CHE), in all instances of non-compliance with the active travel guidance. The CHE's endorsement of any departure submission will be based on the recommendation of a Technical Review Panel (TRP), totally independent of the project team and including at least one member with specialist knowledge of active travel.
- 7.4.11 To ensure a robust peer reviewed auditable approach to decision making is followed then these stages must be included:
- WelTAG Stage 3 designer prepares and agrees report on potential departures from ATAG with the Welsh Government
 - designer submits agreed departure submission using departure from standards proforma to TRP
 - final WCHAR review report including departures from the ATAG endorsed by CHE to be presented to Welsh Government for approval at end of the WelTAG Stage 3
- 7.4.12 In addition, within the immediate geographic area over which the WelTAG study indicates that the trunk road improvement scheme has the potential to contribute to enhancing active travel, reasonable steps must be taken to:
- upgrade any existing trunk road active travel infrastructure to current active travel guidance standards
 - work with the local authority to complete any routes on their approved Active Travel Network Map (ATNM) in parallel with completion of the trunk road improvement scheme
 - work with the local authority to upgrade any of their existing active travel infrastructure to current active travel guidance standards in parallel with completion of the trunk road improvement scheme

7.5 Local roads

7.5.1 For all non-trunk road networks this Active Travel Act Guidance must be considered by local highway authorities when designing active travel routes, even where the advice in this document conflicts with current local authority design standards. Local authorities may also consider guidance contained in the Manual for Streets (MfS) and MfS2 (and any subsequent revisions), but advice contained in this document will take precedence if there is any conflict.

7.5.2 When developing local road schemes, the requirements highlighted in tables 7.1 and 7.2 must be considered and reasonable steps must be taken to:

- upgrade any existing active travel infrastructure to current guidance standards
- work with other local authority departments to complete any routes included on the approved Active Travel Network Map (ATNM) in parallel with completion of the road improvement scheme
- keep a clear audit trail of all active travel decisions made during the course of the planning, design and implementation of the road improvement scheme as per the requirements set out in 7.4 above

7.5.3 The authority shall retain an audit trail for any design decision that does not follow the recommended dimensions and layouts in the Active Travel Act guidance. This documentation will form the basis of the “explanation” required by section 3(6) of the Active Travel Act, which states:

“When submitting an ATNM to the Welsh Ministers under this section a local authority must also submit to them:

a) a statement of the extent (if any) to which any of the active travel routes shown on it do not conform to standards specified in guidance given under section 2(6)

b) an explanation of why the local authority has nevertheless decided that it is appropriate for them to be regarded as active travel routes

7.6 New developments

7.6.1 In conjunction with Planning Policy Wales, this guidance will support the masterplanning, layout and design of development sites, ensuring that all newly planned development is fully accessible by walking and cycling. This applies to private and public sector development, whether mixed use, housing, employment, or public services such as schools and hospitals. It relates to provision within the site and to connections between the site and nearby services, facilities and active travel networks.

7.6.2 Planning Policy Wales 11 clearly states that the sustainable transport hierarchy must be a key principle in the preparation of development plans, including site allocations, and when considering and determining planning applications. Careful consideration needs to be given in development plans to the allocation of new sites which are likely to generate

significant levels of movement, to ensure that access provisions which enable walking and cycling, as well as for public transport, are included from the outset and that any implications associated with airborne pollution can be addressed.

- 7.6.3 The design of development proposals shall, in accordance with the sustainable transport hierarchy, start with identifying the shortest, most attractive walking and cycling connections and then addressing the other transport needs.
- 7.6.4 A key factor within Planning Policy Wales is that “Sustainable transport infrastructure and services should be prioritised and put in place from the outset, before people have moved in and travel patterns have been established.” Local authorities must therefore work closely with developers to ensure they fully understand and implement this guidance.
- 7.6.5 PPW and the act means that authorities should review their design guidelines for developers to ensure that adequate provision is made for active travel by developers’ design teams (and/or refer developers to comply with the ATAG). This will require a consideration of the basic elements making up new highways – motor traffic lane widths, cycle lanes/tracks, footways, verges and so on – to ensure that highways on new developments provide appropriate facilities for walking and cycling as a matter of course.
- 7.6.6 The planning and design of new and improved infrastructure will be led by the Transport Assessment for the new development, which is used to forecast the all-mode travel demands, assess their impact on the surrounding network and design appropriate mitigation measures. It should be noted that smaller developments, on designated active travel routes, which fall below the normal thresholds to provide Transport Assessments should still be required to contribute to active travel improvements.
- 7.6.7 Developments that do not adequately make provision for walking and cycling should not be approved. This may include adequate off-site improvements for pedestrians and cyclists using existing highways that are affected by the development.
- 7.6.8 Planning Policy Wales 11 requires that sustainable transport measures be included before the development is complete “Importantly, sustainable transport infrastructure and services should be prioritised and put in place from the outset, before people have moved in and travel patterns have been established”.

7.7 Land acquisition

- 7.7.1 Chapter 9 outlines the process for showing routes on the ATNM which are not owned by the local authority or within the highway boundary.
- 7.7.2 The Welsh Government believes compulsory purchase powers are an important tool for local authorities and other public bodies (“acquiring authorities”) to use as a means of assembling the land needed to help deliver environmental, social and economic change. Used properly, they can contribute towards effective and efficient regeneration, placemaking, the revitalisation of communities, and the promotion of business – leading to improvements in the quality of life. Acquiring authorities possessing compulsory

purchase powers – at whatever level – are encouraged to consider using them pro-actively where the acquisition of land cannot be achieved by agreement to ensure real gains are brought to residents and the business community without delay.

- 7.7.3 A circular has been produced by the Welsh Government (Compulsory Purchase in Wales and ‘The Criche Down Rules (Wales Version 2020)’ (Circular 003/2019) | GOV.WALES) which specifically refers to compulsory purchase for the purpose of providing active travel routes, key sections are outlined in table 7.3

Table 7.3 – Relevant sections of the circular relating to compulsory purchase of land for active travel purposes

Paragraph	Text
Section G Paragraph 26	CPOs which are made to acquire land for the purposes of facilitating an active travel route will carry a strong public interest case for the promotion or improvement of the environmental and social well-being of an area. The proposals are usually the result of prior public consultation, demonstrating demand and support
Section G Paragraph 28	The nature of active travel, however, is that any given walking path or cycle route may have an alternative which can circumvent the need to acquire land/individual properties via a CPO. Acquiring authorities should always consider and undertake an assessment of suitable alternatives as part of the planning process for a CPO. This will help address any potential alternative proposals which could be put forward by objectors. In some locations there may be no other suitable alternative routes, i.e. due to physical or geographical reasons, and acquiring authorities should make reference as to why this is the case
Section G Paragraph 24	<p>If an alternative proposal is made by an objector to a CPO, the decision-maker must consider the alternative put forward and evaluate it when judging whether there is a compelling case in the public interest for the CPO. However, the decision maker is not bound to favour an alternative on the basis that it is less intrusive than the scheme proposed. Alternative proposals may not be preferable if they are:</p> <p>(1) uncertain in their delivery of the objectives which underpin the public interest basis for confirming the CPO, e.g. because they do not secure the delivery of the objectives of the acquisition scheme in the public interest, lack the relevant permissions or consents, or generally lack certainty in the delivery of relevant proposals in the public interest; (2) will delay the implementation of the CPO scheme where a timely delivery of the proposals is in the public interest; or (3) will not deliver the public interest benefits of the CPO scheme as well or as effectively as that scheme, or in the timely manner of the scheme where that difference in delivery of benefits and timing are material ones having regard to the public interest</p>

7.8 Innovation and experimentation

- 7.8.1 The challenge of reallocating highway space in our towns and cities is leading practitioners towards use of new and innovative ideas. Welsh Government policy, Manual for Streets and Manual for Streets 2 requires that street design should not follow the conventional engineering-led approach.
- 7.8.2 The development and trial of more innovative infrastructure for walking and cycling will be essential if Wales is to achieve a step change in the amount of people using active travel modes. This guidance aims to support both innovation and well-established techniques. The design elements contained within the guidance have been classified, as described in 7.9.2 below. This second edition (2021) of the guidance incorporates changes in design practice made possible since the publication of TSRGD 2016.

7.9 Design elements

- 7.9.1 Appendix G consists of a set of 'Design elements', which provide concise instruction, including dimensioned drawings where appropriate, on the layout and use of particular types of design solution. Further information on these infrastructure measures are included within chapter 11 and chapter 12.
- 7.9.2 Each design element has been given one of three statuses, defined as:



Standard details

Details that are well understood and should be applied as shown, as a minimum, unless there are particular reasons for local variation.



Suggested details

Details that have not been widely applied in Wales but should be considered appropriate for use in the circumstances as advised.



Possible details

Details that are uncommon in Wales but have been used successfully in other places and may be considered for use in schemes to gain further experience.

- 7.9.3 Within this document those elements denoted as Standard Details will be regarded as "standards" for the purposes of section 3(6)(a) of the Active Travel Act.
- 7.9.4 The use of advice categorised as Suggested Details or Possible Details will require careful monitoring by the highway authorities who implement them to ensure that they perform as expected. Welsh Government welcomes feedback on any lessons learned to improve the guidance and to assist other highway authorities that are developing innovative schemes.
- 7.9.5 Within technical details in chapter 11 and chapter 12, and the design elements (Appendix G) the terms 'absolute minimum' and 'desirable minimum' are used. Desirable minimum is the best practice provision which should be provided whenever possible. If the lesser standard absolute minimum is used then the designer shall keep an audit trail

of decisions made to justify why the best practice level of provision can not be provided. Any proposed infrastructure below absolute minimum should not be developed or constructed.

7.10 Keeping standards up to date

- 7.10.1 Walking and cycling design guidance is constantly evolving. The intention is that this guidance will be updated to take account of changes to design standards, new legislation or experience learnt from those implementing the solutions contained within the document. This is expected to result in changes to the main guidance document and the status of some design elements, as experience is gained, together with the addition and/or deletion of others.
- 7.10.2 User views are essential for the successful evolution of this document and so all who use this guidance are encouraged to submit comments. These comments should be emailed to the following address: activetravel@wales.gov.uk



Chapter 8: Engagement and consultation methods

This chapter provides general advice on good practice methods for engaging and consulting with the public and stakeholders on the development of active travel networks and schemes. The requirements for consultation and providing evidence of consultation during the production and submission of the ATNM are set out in chapter 5 and Appendix D.

Key considerations include:

- addressing the principles of engagement and consultation
- engagement throughout the preparation of ATNMs as well as undertaking more detailed engagement for scheme delivery
- ensuring compliance with the Equality Act 2010, specifically by undertaking meaningful engagement with groups representing people with protected characteristics

8.1 Introduction

8.1.1 Effective engagement and consultation results in better design and better schemes. The more opportunity people have to influence and shape walking and cycling schemes for their local area, the more likely they will be to use them.

8.1.2 The consultation and engagement process can highlight differences in opinion, and often result in contradictory requests/suggestions. However, alongside reliable quantitative data, the process can also act as an effective test for a mandate for progressing what may be for some people controversial active travel proposals. The opportunity for stakeholders and the public to highlight issues or requests that can be incorporated at an early stage can help reduce the risk of opposition at later stages of the project.

8.1.3 The terms consultation and engagement are used in this guidance to describe the processes used to seek feedback and suggestions from the public and specific stakeholders. In practice there is a continuum of participation which starts with simple consultation and culminates in co-creation or co-production where schemes are designed wholly through participatory processes. This is sometimes referred to as the 'ladder of participation'. More involved levels often result in better schemes with higher levels of buy-in and ownership which can result in more people making use of the new infrastructure. They require high levels of resource and commitment from all sides and can disadvantage the time-poor. There remains therefore an important role for less intensive opportunities for consultation and engagement.

8.1.4 This chapter discusses good practice methods that may be suitable in a range of circumstances. In reality the context of each active travel scheme will differ, and local authorities should consider this within their engagement and consultation plans.

COVID-19 has highlighted the need for such methods to be flexible and has provided an opportunity to develop and test new methods of engagement for example using online engagement platforms.

8.2 Addressing the principles

8.2.1 The key principles for engagement are introduced in chapter 5. This section provides further detail, good practice methods and considerations that will help in ensuring engagement and consultation exercises are accessible, broad, establish clear parameters and use suitable tools.

Accessible

- 8.2.2 Consultations on active travel networks and schemes must be accessible to all people. Officers or consultants acting on behalf of those managing a project should be experienced in engaging diverse communities.
- 8.2.3 The location of an in-person event should be considered to allow for the best chance of attendance. Such events should be well located for the audience. Where possible, public events should be able to be clearly viewed by those passing-by as opposed to behind a closed door. For example, an event located in an accessible market hall or High Street setting is likely to lead to more engagement than an event held in the offices of a local authority.
- 8.2.4 Online events can provide an effective way to involve a wider audience than would feasibly be able to attend an in-person event, and combined with in-person engagement is often an efficient means of collecting high volumes of feedback. Consideration should be given to ensuring any digital platform used for engagement is available and clear on all devices (e.g. mobile phones, tablets and laptops) and making alternative provision available to enable people who cannot access digital platforms the ability to have their say.
- 8.2.5 Ideally, a combination of in-person and online events should be held to help gather a wide representation of feedback. Where this is not possible (for example, social distancing requirements restricting in-person events), methods such as telephone surveys or letter-drops may be useful sources for feedback for those unable or unlikely to comment online. A simple survey, delivered with a pre-paid envelope, is an effective way of gathering feedback.
- 8.2.6 Local authorities must specifically seek to engage with groups with protected characteristics under the Equality Act 2010. Local authorities should consider the format of the consultation materials and any consultation events to best meet this duty. For example, by producing an easy read version of the consultation and having staff available to assist participants, or if online, allowing the users to change colour schemes, contrast levels and alternative navigation/screen-reading features should all be considered.
- 8.2.7 A wide range of media should be used, including printed notices and social media – some of these methods may not be accessible for all groups and targeted engagement may be necessary – for example using local radio, sessions with community groups such as access and disability groups, and cultural groups where the main language is not Welsh or English. When engaging with children and young people, their perspective and needs must be considered.

Rights of children and young persons

In exercising their functions under the Active Travel (Wales) Act 2013, local authorities are required to undertake all reasonable measures to ensure that children and young people are involved in the planning, implementation and review of decision-making processes. In doing so, local authorities can make use of existing mechanisms including local schools councils, youth councils and advocacy services. All engagement with children and young people should be informed by the Children and Young People's National Participation Standards for Wales, published by Welsh Government. This document stresses that children and young people's participation is an ongoing process rather than simply a series of one-off engagement events.

- 8.2.8 Unnecessary technical details and jargon should not be used when presenting information. Drawings and scheme illustrations should not assume any kind of engineering knowledge held by those being consulted and should include clear descriptive text to aid interpretation.
- 8.2.9 This can be achieved through the inclusion of maps which put the scheme into context. To avoid unnecessary technical information, the use of figures, sketches, and examples of similar schemes can be used. Where technical terms are necessary, an explanation must be included to ensure it is understood. Acronyms and abbreviations should be avoided or explained.

Broad

- 8.2.10 Effective consultation at network and scheme level needs to target both current and potential users of walking and cycling infrastructure. Whilst the focus of active travel engagement will be upon utility journeys, these routes may also be used for leisure and sports purposes, including equestrians in rural/semi-rural areas and so this should be borne in mind when targeting who to seek input from during the engagement and consultation process.
- 8.2.11 Involving a large number and broad range of people can be done by reaching them through major trip generators such as employers, schools, higher and further education institutions and hospitals. This may also include local businesses, community and special interest groups.
- 8.2.12 Early engagement within the local authority itself, in particular those authorities where network planning and scheme delivery are separated, is also essential, as is engagement with elected members, town and community councils. Further guidance on the range of local authority departments and individual officers who can contribute to the successful development of active travel strategies, networks and routes is provided within chapter 10.

Establishing clear parameters

- 8.2.13 It is important to set clear parameters for any contact with the public and other stakeholders, so that they understand what can and cannot be changed as a result of their involvement, thus managing expectations.

8.2.14 The nature and scope of the process should be clearly defined and this should include both its mechanisms, including timescales, and the expected output of the activity, including any decision processes that follow. The amount of information asked for from those being consulted/engaged should be minimised to what is of relevance for the purpose of the exercise.

8.3 Tools for participation and consultation

8.3.1 There is a vast and constantly evolving range of consultation and engagement tools and methods, many of which would be suitable for consulting on active travel networks and schemes. These include:

- events at key destinations and trip generators
- dedicated online consultation sites
- community street audits
- cycle route inspections
- posters and site notices along routes
- telephone surveys
- letter drops
- social media led events and online forum discussions, targeted at current or potential active travellers
- wider forums
- events on radio and other local media

Case study

Newtown pedestrian/cycling bridge community consultation

Background: Following requests from the local community for a bridge across the River Severn in Newtown, Powys County Council (Powys CC) undertook a feasibility study to identify a suitable site and investigate a connection between the housing and retail/employment opportunities on either side of the river. Subsequent engagement with the local community, including consultations through the ATNM process, regularly demonstrated strong local support for this crossing.

Stakeholder engagement: With increased funding for active travel being made available by Welsh Government, Powys CC were able to develop an initial concept design to facilitate discussions with local stakeholders. A set of images were drawn up and used to work with various groups including local sports clubs (rugby/tennis), the town council, walking and cycle groups and local access groups representing disabled people. These stakeholders were able to communicate with their members and local residents, and helped secure grass roots level support for the bridge as part of a funding bid to Welsh Government.

Community engagement process: Having been successful in securing funding to construct the bridge, the council wanted to continue in the spirit of co-production during the design process and arranged a series of engagement sessions with the general public. The location and span of the proposed bridge meant that only 2 possible construction methods were feasible (cable stay and cable arch), but there was considerable scope for the public to provide input to the style and aesthetics of the bridge. The council ensured that the brief given to the designers included a requirement for community engagement, and as a result the design team took part in the community engagement sessions.

Two events were organised and advertised in the local press, with the venues and times chosen in order to capture a range of people. Session 1 was held in the town's indoor market hall during an afternoon, whilst Session 2 was held one evening in the local pub. 30-40 people attended each event and they were asked to look at a range of images of other bridges from around the world, and to choose which ones they liked the most by using coloured dots to identify their preference. Feedback from the sessions helped to refine the design process for the bridge as well as adding local input into the key links and connections to destinations in the town.

Figure 8.1 – Community consultation event

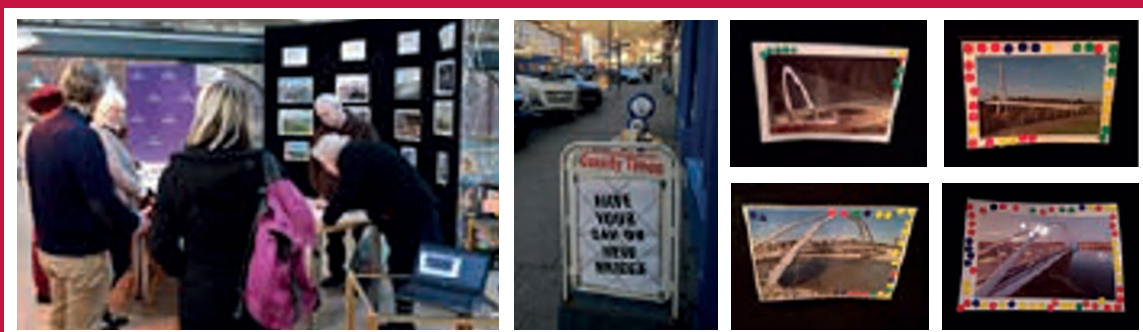

8.4 Active travel network map (ATNM) engagement and consultation

- 8.4.1 The preparation of the ATNM represents a significant opportunity for stakeholders to influence how active travel networks, routes and facilities will be developed over the long-term. As such, it is vital that sufficient opportunities are made available to gather the views of those wishing to participate. Engagement events and materials also provide an opportunity to directly promote active travel.
- 8.4.2 Chapter 10 sets out the methodologies for planning walking and cycling networks and suggests a two-stage approach to engagement in respect of the preparation of the network proposals for the statutory consultation period.

When to consult

- 8.4.3 The first opportunity for engagement is at the route identification stage. This will ensure the views of the public and stakeholders are considered at an early stage in the development of the ATNM and will supplement the routes identified by local authorities when following other methodologies explained in chapter 10. The second opportunity for engagement is at the validation stage, where stakeholders will have the chance to view the proposed networks in their entirety and be able to make additional comments or suggestions to enhance or challenge the routes and networks identified.

Figure 8.2 – Commonplace heatmap used during ATNM engagement



8.4.4 There is statutory requirement to seek the public's views during the formal consultation on the draft ATNM, as described in chapter 5. Where early engagement at route identification stage provided a large number of new proposals or strongly conflicting views, a local authority may wish to undertake an additional interim stage of engagement before the formal consultation on the draft map. This gives the public and stakeholders the chance to view the proposed networks in their entirety and make additional comments and suggestions to enhance or challenge the routes and networks identified. This is likely to result in fewer changes post-statutory consultation, but the interim step is not a formal requirement.

Who to consult/engage

8.4.5 The full list of who shall be involved by a local authority during its engagement and consultation process is provided in chapter 5.

8.4.6 Engaging with children and young people in the consultation process is an important requirement. This should be done both through educational establishments but also through youth groups and other forums where young people meet.

Standalone events can be organised but local authorities can also use evidence collected through others means where young people's involvement can be demonstrated, including;

- the development of school travel plans or community access plans
- school health research network questionnaires
- involvement through behaviour change programmes such as Active Journeys and WOW (Walk to School)

8.4.7 Local authorities should liaise with other stakeholder organisations and agencies to identify opportunities to collaborate on shared engagement events to help maximise potential attendance, and minimise the risk of consultation fatigue.

8.4.8 By establishing an overarching engagement and consultation framework local authorities will have in place a list of stakeholders who wish to be involved, a stated process for how members of the public can register to be consulted and other details such as how and when elected members and ward councillors are to be involved.

8.4.9 Consultation on The ATNM does not negate any statutory requirements for consultation that may be required as part of an individual scheme (for example, as part of a Compulsory Purchase Order or Traffic Regulation Order). In addition to the recommendations provided within this chapter, there are also requirements in relation to individual active travel scheme delivery to ensure that new infrastructure meets the needs of the wider community, not just walkers and cyclists. The local authority should follow its normal engagement and consultation processes in relation to schemes.

8.5 Scheme delivery and consultation

8.5.1 In addition to the consultation and engagement required to develop The ATNM, there are also requirements in relation to consultation on individual active travel schemes.

- 8.5.2 Consultation and engagement on projects should align with the scale of the scheme and populations affected by it. The principle of co-production should be applied to the development of key schemes that would benefit from this approach. For bigger schemes or a programme of work, engagement is best carried out at several stages throughout the project. For minor works, e.g. provision of a drop kerb crossing, statutory processes may be sufficient, but this decision should be taken on a case by case basis.
- 8.5.3 For the majority of schemes, it will be appropriate to undertake engagement at two key points during the development process. The initial involvement should take place early in the project’s development. This could form part of the Stage One WelTAG assessment process where stakeholders feed into the identification of issues, objectives and initial concepts associated with the scheme. Where a new route is proposed to connect a primary school to a residential development, for instance, representatives of the school and the local community should be involved to help identify an appropriate solution.
- 8.5.4 A second opportunity for engagement should take place following completion of the outline design of a single scheme option to provide a further opportunity for refining the scheme design and influencing the final outcome. As a minimum, local authorities would be expected to consult with local elected members, town and community councils as well as local residents, stakeholders, businesses and landowners likely to be affected by the scheme.
- 8.5.5 Local authorities may wish to carry out the second stage of engagement following the concept design stage, where stakeholders are likely to have a greater opportunity to influence the scheme design. However, managing expectations is fundamental and the information provided to support this process should clearly communicate what parameters of the proposal participants are able to suggest changes to.

Figure 8.3 – Engagement and consultation process for new schemes

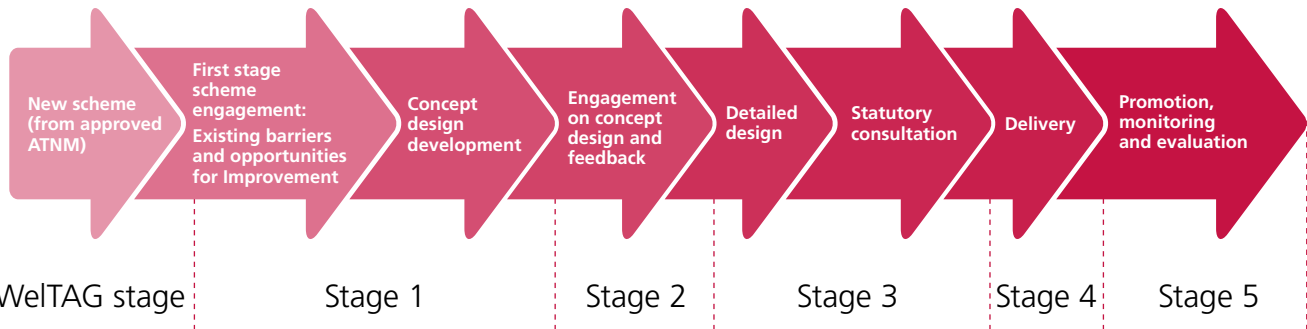



SHARE
CARE

Chapter 9: User needs

This chapter sets out the basic needs of people when they make journeys whilst walking or cycling, recognising the diverse characteristics of different user groups which infrastructure planning and design needs to reflect.

Key considerations include:

- designing for the dynamic envelope of pedestrians and cyclists
- considerations which need to be made in the design process for the increased popularity of e-cycles
- when planning for new routes, separate spaces for walking and cycling should be the aim

9.1 Similarities and differences

9.1.1 The following characteristics summarise the needs of people walking and cycling. Active travel routes should be:

- coherent
- direct
- safe
- attractive
- comfortable

9.1.2 Walking and cycling share many similarities, including many of the barriers to uptake, such as concerns over safety and poor, or missing infrastructure.

9.1.3 There are also important differences between walking and cycling for design purposes. Pedestrians and cyclists have distinct needs which require different approaches to planning networks and designing infrastructure. In some circumstances, pedestrians and cyclists can share the same space safely and effectively, and the design of such areas is covered in chapter 11.

9.1.4 Ideally when planning new routes, designers should seek to provide separate spaces for pedestrians and cyclists, to accommodate expected growth in users, and so that both groups can travel without concerns over conflict.

9.1.5 Walking is most suitable for journeys of less than two miles whilst cycling is also convenient for longer journeys, typically up to five miles for regular utility journeys (although a rise in popularity of e-cycles can increase the distances covered). Both modes can contribute to part of a longer journey, for example as the first/last leg of a public transport journey (explored in further detail in chapter 13).

9.1.6 Improving conditions for one active travel mode should not be at the expense of the other, for example by reducing footway widths below the recommended width to accommodate a separated cycle facility. Local authorities should always aim to improve conditions both active travel modes when developing schemes.

9.2 Principles for user needs

9.2.1 Adhering to the following principles will help ensure active travel projects accommodate user needs;

- develop ideas collaboratively and in partnership with communities
- facilitate independent walking, cycling and wheeling for everyone, accommodating the needs of an unaccompanied child of secondary school age, someone pushing a double-buggy, an adapted cycle, or a less-experienced cyclist
- design places that provide enjoyment, comfort and protection
- ensure access for all and equality of opportunity in public space
- ensure all proposals are developed in a way that is context-specific and evidence-led
- schemes should separate people walking, cycling and wheeling from motor vehicles or prioritise them. Figure 9.1 and 9.2 give an overview of the design options available, which are each explored further in chapter 11.

Figure 9.1 – Examples of infrastructure illustrating design principles



Separation of pedestrians from cyclists and motor traffic through provision of separated off-carriageway infrastructure; if necessary through reallocation of road space



Separation of pedestrians and cyclists from motor traffic through provision of shared-use off-carriageway infrastructure

9.2.2 In areas where separation from motor traffic is unfeasible, it may be possible to improve conditions by removal of through traffic along the route or other appropriate traffic calming means, such as via modal filters, quiet street or cycle street provision (see Appendix G, Design Elements DE205 & DE206). This can be particularly beneficial for residential areas where access by motor vehicle is still required (e.g. for residents, emergency vehicles and refuse vehicles).

Figure 9.2 – Modal filter



Image of modal filter, Riverside, Cardiff (note that a build out into the parking bay is also recommended to avoid vehicles parking across the dropped kerb)

Figure 9.3 – Cycle street



Image of cycle street (including sustainable drainage features) in Grangetown, Cardiff

9.2.3 Such interventions have wider benefits than just increasing the attractiveness of walking and cycling; such as improved local air quality, reduced noise pollution, improved sense of community and a safer environment for children to play.

9.3 Inclusive design

9.3.1 Under the Equality Act (2010), public sector authorities have a duty to make reasonable adjustments to the built environment to ensure the design of new infrastructure is accessible to all. The requirement for inclusive design applies to both pedestrians and cyclists, as defined within the act.

- a. People who walk
- b. People who use pedal cycles, other than pedal cycles which are motor vehicles for the purposes of the Road Traffic Act 1988, and
- c. Disabled people not within paragraph (a) or (b) who use motorised wheelchairs, mobility scooters or other aids to mobility

9.3.2 Disabled people may need to use mobility scooters, wheelchairs, adapted or non-standard cycles (such as tricycles, quadricycles or hand cycles), which require the careful design of facilities to make sure that their greater width and turning space requirements can be accommodated.

Figure 9.4: User of a recumbent trike, Cardiff



9.3.3 Opportunities for rest, such as seating, are helpful, not just for older pedestrians and those with physical disabilities. Routes which pass close to or provide clear signposting to accessible public toilets are particularly important for those users and people with children.

Figure 9.5: A range of seating options grouped together to suit different users



9.3.4 Disabled people are not a homogenous group, and it is important that the full range of diverse needs is considered and accounted for in the design process.

9.3.5 Environments which accommodate the needs of disabled people will be helpful to others, for example people carrying heavy shopping or pushing a pushchair.

9.3.6 As introduced in Part 1, there is a correlation between likelihood to use active modes and certain protected characteristic groups, with evidence supporting that sex, disability, race and age all impact on a person's likelihood to use active modes. This correlation is particularly evident when comparing cycling levels.

9.3.7 Inclusive cycling in cities and towns, a report on how to create better spaces for everyone Sustrans and Arup 2020 included the following recommendations:

- improve road safety, primarily through protected space for cycling and low traffic neighbourhoods
- address personal safety and harassment
- ensure cycling infrastructure is fully inclusive
- better integrate cycling between residential areas, trip generators and with public transport
- prioritise infrastructure where transport options are poor, especially where this coincides with multiple deprivation

9.3.8 Whilst this report focused specifically on cycling, understanding barriers to walking suggests it is likely that these recommendations can be adapted to encourage increased uptake of walking among underrepresented groups.

9.3.9 Local authorities must follow requirements to undertake Equality Impact Assessments and be clear that the purpose is to ensure the impact of schemes on people with protected characteristics are fully considered, as required by the Equality Act. The detail needed is linked to the complexity of the scheme, with straightforward schemes only needing a short EQiA.

9.3.10 Local authorities should follow their own Equality Impact Assessment (EQiA) processes and associated guidance. [UK Research Councils](#) also provide a template EQiA which provides useful guidance.

9.3.11 Key to achieving the above is to ensure underrepresented groups are involved throughout the design process and local authority equalities officers should be involved from the earliest stage.

9.4 Minimising user effort

9.4.1 Pedestrians and cyclists are moving under their own efforts, and are therefore more adversely impacted by the physical environment and seemingly minor deviations or obstructions, when compared to motor traffic.

9.4.2 The conservation of effort and momentum (particularly for users with mobility aids and cyclists) should be considered. Good design enables people to travel with the minimum of effort by addressing as many of the factors that make up the physical environment as possible. Features that increase effort include; the surface material and any deformations; deviations or diversions from the shortest distance; and for mobility scooter, wheelchair users and cyclists, frequent stopping and starting.

9.4.3 Strong head or cross winds and uphill gradients will also increase the effort required, though the effects of these can still be reduced by considered design (for example, providing zig-zag ramps or a vegetation buffer).

Table 9.1 – Factors affecting effort required by pedestrians and cyclists

Factors affecting effort required		Meaning	Design implications
The user and mobility equipment (e.g. wheelchair/cycle)	Speed travelled. Efficiency of mobility aid/cycle. Mass of user	All these factors, taken together, means that stopping and starting require a lot of effort; much more than maintaining a constant speed It also means that lighter mobility aids/cycles require less effort to move and that it is a good idea to maintain these in optimum working order	Routes that are direct and allow users to maintain their speed are the most appealing to users – designers should avoid making users stop, slow down, or deviate unnecessarily from their route
Surface quality	Resistance of the surface	The greater the surface resistance, the harder it is to use wheeled mobility aids (this is particularly true for wheelchairs, pushchairs and small-wheeled cycles)	The quality and smoothness of the surface, and its continued maintenance, are essential for comfort and efficiency
Gradient	Slope or crossfall	The steeper the gradient, the more energy is required to overcome it. Excessive crossfall/cambers are uncomfortable for users and require additional energy use	Directness of route may need to be balanced with avoiding steep gradients or providing landings (rest areas). Balancing user and drainage requirements should be considered
Air resistance	Headwinds or crosswinds Frontal area and drag coefficient	Walking, pushing a mobility aid or cycling into a prevailing headwind, requires much more effort from the user. Local conditions, such as microclimate around tall buildings, can exacerbate this The frontal area of a cyclist also impacts upon this: upright cyclists using 'city bikes' have to generate more power	Designing to reduce headwind effects has not been commonplace in Wales but can make a large difference Windbreaks using planting, trees or fences, can help mitigate the effects of strong winds

9.5 Pedestrian needs

9.5.1 In this document, pedestrian is used as shorthand for anyone who is undertaking a journey as a 'walker' under the act, or anyone who is undertaking a journey using a motorised wheelchair, mobility scooter or other aid to mobility (including manual wheelchairs and pushchairs). This chapter explores the 5 key principles introduced in section 9.1 before exploring more specific needs and considerations for pedestrians.

Coherent (Pedestrians)

9.5.2 Pedestrian routes must allow people to easily walk from residential areas to destinations including shops, schools, transport interchanges, bus stops and other community facilities in a way which is legible and easily navigable. Features that improve coherence include:

- seamlessly connecting routes that form a logical and permeable network
- high quality and appropriately placed signage, proportionate to the route type and likely user groups (this may include icons to depict destinations or, in collaboration with relevant representative organisations, braille or tactile embossed signage)
- attractive features that overcome or reduce severance wherever possible, for example routes across busy roads, railway lines or watercourses. Where possible, subways or footbridges for pedestrians should be avoided in favour of at-grade crossings to avoid perceptions of danger and reduce deviation required

9.5.3 Walkable neighbourhoods also referred to as 'low-traffic neighbourhoods', or 'active neighbourhoods', (see figure 9.6) are characterised by having a range of facilities within 20 minutes' walking distance which people may access comfortably on foot, although it is important to note that walking speed may be slower for some users. The creation of mixed-use neighbourhoods with interconnected street patterns, where daily needs are within walking distance of most residents have been found to result in greater levels of walking.

Figure 9.6 – Low traffic neighbourhoods Waltham Forest



9.5.4 Most existing examples of low traffic neighbourhoods are focused within the suburbs of larger towns or cities. But they can also be applied in the context of settlements within the more rural counties of Wales. Many of these local service centres will already have a range of facilities within a 20 minute walking distance of one-another, where opportunities may exist to improve the walking environments to create a walkable-settlement. This is illustrated by a [poll](#) conducted by The Ramblers in 2019 which found that Aberystwyth in Ceredigion was ranked the fourth most walkable settlement in the UK, with good public transport links and traffic calming interventions cited as contributing factors.

Direct (Pedestrians)

9.5.5 Pedestrians are moving under their own efforts and therefore require routes and networks which are direct and follow natural desire lines (see chapter 10 for pedestrian network planning methods). Features that improve a route's directness may include:

- reducing the distance required for pedestrians to travel between destinations, e.g. provision of cut-throughs within housing estates, retail and business parks
- reducing corner radii at side road junctions to avoid deviation or crossing time. This also contributes to user safety by reducing vehicle speeds. Furthermore, narrowing the side junction radius also benefits blind and partially sighted pedestrians by reducing the distance needed to navigate in a straight line
- providing continuous crossings over side road entrances, as well as dedicated crossing points that prioritise pedestrians where desire lines cross a feature of severance (e.g. road)

9.5.6 Many housing developments have convoluted and impermeable layouts, often driven by an understandable desire to control motor traffic speeds. However, this is often delivered at the expense of providing direct routes for pedestrians. Routes that reduce the walking distance needed to travel for active users are essential in encouraging modal shift. In Wales, developers and planners must now demonstrate how new developments actively favour pedestrian, and cycle movement by design.

Safe (Pedestrians)

9.5.7 Safety (both actual and perceived) is an essential user need for pedestrians, both in the form of preventing physical harm through collisions with vehicles, and minimising threats to personal safety. Safety improvements can include:

- separating pedestrians from the routes of other faster modes vehicles or commuter cycle routes
- reducing vehicle speeds and flows
- increasing the build quality and maintenance of pedestrian routes
- promoting pedestrian routes that are overlooked by buildings or areas which are well-used

- 9.5.8 Fears over personal safety can be a major barrier to walking. Street lighting is an important influence upon this. Local authorities should ensure urban streets and paths are well lit at times they are likely to be used. Street lighting should provide an attractive environment which provides reassurance for pedestrians and any faults should be repaired quickly. Off-road paths may need to use low-level or surface lighting to minimise the impact on wildlife.

Figure 9.7 – Low level lighting, Newport



- 9.5.9 Environmental anti-social activity such as graffiti, litter or vandalism should be removed or repaired quickly, or ideally mitigated against by the provision of lighting or other suitable design features. Pedestrian routes should have clear exit and entrance points where people cannot be trapped, avoiding blind corners. Overhanging vegetation should be reduced to improve sight lines and to prevent it becoming an obstruction. It is also important that highway authorities work with other partners such as the police to ensure pedestrians feel safe using walking routes through initiatives such as regular community policing where there is a high level of perception of risk.

Attractive (Pedestrians)

- 9.5.10 Attractive pedestrian routes not only encourage more people to walk but can also contribute to the overall quality of an area and help to create an improved sense of place through the creation of more accessible public spaces. Features that may improve attractiveness could include:
- effective use of environmental features that can both improve user experience, but also act as environmental mitigation or sustainable drainage features (see chapter 11)
 - ensuring design considers future maintenance of a route, and that routes are regularly maintained to the appropriate levels (chapter 15)
 - ensuring the designs are developed with the involvement of the local community to ensure local 'buy-in' for the scheme

- enhancing routes by the inclusion of formal or informal play-spaces and green infrastructure

- 9.5.11 Manual for Streets remarks 'The propensity to walk is influenced not only by distance, but also by the quality of the walking experience. A 20 minute walk alongside a busy highway can seem endless, yet in a rich and stimulating street, such as in a town centre, it can pass without noticing. Residential areas can offer a pleasant walking experience if good quality landscaping, gardens or interesting architecture are present' (MfS, Para 6.3.1).
- 9.5.12 Pedestrian routes can deliver both a place (destination) and movement (travelling through) function although the balance between such functions may depend on external influences such as the time of day or day of the week. A pedestrian route may deliver a movement function during the working week and revert to more of a place function during the weekend, for example by being used for a street market. In suitable locations, incorporating formal or informal opportunities for play through hard and soft landscaping or small items of equipment, can increase the enjoyment and with it the likely use of a route.
- 9.5.13 As well as encouraging active travel, attractive streets and public realm can deliver increased economic activity through increases in footfall and rateable values of high streets.

Comfortable (pedestrians)

- 9.5.14 Pedestrian comfort is influenced by a range of factors including the basic design of the route – its width as related to the number of users and the gradient and quality of the surface – as well as elements such as tactile paving, street furniture, drainage, cleanliness and lighting. Width is the key consideration for the comfort of pedestrian routes and this is dealt with in section 9.6. Other features that can increase levels of comfort for pedestrians include:
- avoidance of permanent street furniture within the footway (or if unavoidable away from the main pedestrian flows with appropriate clearance widths and lighting provided)
 - avoidance of the use of A-board advertisements which may pose a risk to older people and those with visual impairments
 - enforcement, or implementation of features that help to prevent (whilst being mindful of clearance width requirements) footway parking. This may include features that contribute to other aims such as street trees, planters, or play

9.6 Dimensions for pedestrian routes

Footway widths

- 9.6.1 Basic width requirements for different types of people walking or using mobility aids are given in [Inclusive Mobility](#) and Manual for Streets which is the source for figure 9.8.

Figure 9.8 – Width requirements from MfS

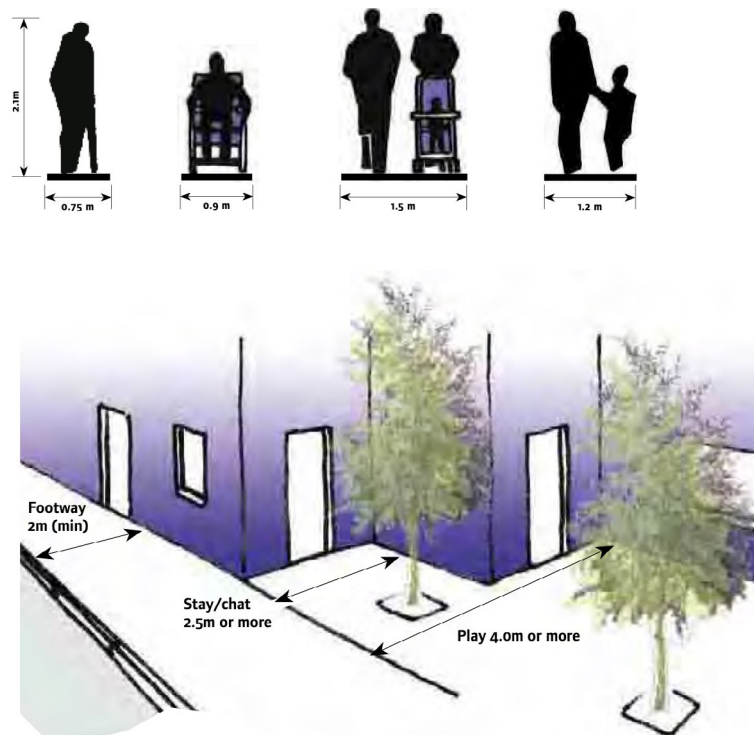

- 9.6.2 Pedestrian routes should have a clear unobstructed width of 2.0m (desirable minimum), which allows two wheelchair users to pass one other. Where physical constraints make this impossible a clear width of 1.5m (absolute minimum) should be maintained to enable a wheelchair user and walking companion to travel side by side. If there is an obstacle that cannot be moved a restricted width of 1.2m provides space for a blind or partially sighted person to walk using a long cane, or with a guide dog, or alongside a person providing guidance.
- 9.6.3 Some routes will require greater width than the minimum given above due to the number of pedestrians that habitually use the route and/or the main category of user. A suitable footway width is important to allow pedestrians to travel comfortably at their chosen speed and in groups, such as when walking with younger children. For example, the areas around schools will be used by large numbers of children and young people at the start and end of the school day. Hospitals will generate large numbers of movements of people with a range of physical, sensory or cognitive impairments and a range of mobility needs.
- 9.6.4 Further detail on the assessment of pedestrian capacity is given in [Transport for London's Pedestrian Comfort Guidance for London \(2019\)](#). It defines levels of service for pedestrian capacity in terms of pedestrians per minute per metre width (ppmm) and defines area types with peak pedestrian times including high street, office and retail, residential, tourist attractions and transport interchanges. Generally a minimum level of service B+ should be achieved on all active travel routes.

Figure 9.9 – TfL pedestrian comfort levels



9.6.5 Additional width should also be considered at locations where pedestrians move at different speeds, such as high streets, at bus stops, or where they are required to wait before crossing. This is particularly important at signal controlled crossings, where, depending on the crossing layout, users waiting on either side are likely to converge on a central island at the same time. If an island, a queue for crossing is too busy, pedestrians will be likely to cross the carriageway elsewhere.

9.6.6 Additional width may be required between the carriageway and footway, depending on the speed of the adjacent carriageway. Where vehicle speeds are in excess of 40mph,

or with an average of over 1,500 Heavy Goods Vehicles per day, an additional minimum 500mm width of footway or verge is recommended.

- 9.6.7 Such a 'buffer strip' between the pedestrian route and carriageway/cycle track can contribute positively to the safety (perceived and actual) and comfort of a route, and has the potential to incorporate planting or sustainable drainage features. The buffer or verge also helps protect pedestrians from the air turbulence created by passing motor traffic and from debris that may be thrown from the carriageway.
- 9.6.8 Gaps in the buffer strips should include provision for users to cross as close to the desire lines as possible, in accordance with the correct use of tactile paving and drop kerb provision.
- 9.6.9 Additional width may also be required where busy pedestrian routes are bounded by a vertical feature, such as a wall, as such features may contribute to an effectively unusable section of footway of up to 0.5m. Additional details see chapter 11, paragraph 11.17 and DE101.

Visibility at pedestrian crossings

- 9.6.10 Pedestrians should be able to see and be seen by approaching traffic. Different groups will have different requirements – for example, wheelchair users and children may be harder for a driver to see because of their lower height.
- 9.6.11 Visibility at crossings should not be obscured or restricted by factors such as parked vehicles, trees or street furniture. Obstacles should be moved or removed wherever possible, especially if doing so enables a crossing to remain on the desire line. If the carriageway is wide enough, it may be worth building out the footway to provide enhanced sight lines. Street furniture such as controller cabinets should be placed in a position that does not obstruct intervisibility between pedestrians and approaching vehicles.
- 9.6.12 Minimum distances for visibility of crossings for approaching traffic are set out in table 9.2. These are taken from [Traffic Signs Manual chapter 6 section 15.5](#)

Table 9.2 – Recommended visibility distances for pedestrian crossings

85th percentile speed (mph)	20	26	30	35	40
Recommended stopping sight distance (m)	22	31	40	51	80

9.7 Gradients for pedestrian routes

- 9.7.1 Steep gradients have an impact on accessibility for some older people, disabled people and people with pushchairs or other loads:
 - 1% (1 in 100) – is never an obstacle
 - 2% (1 in 50) – can be managed by most people (and also provides good drainage)

- 2.5% (1 in 40) – can be managed by many people
- steeper than 2.5% – difficult for many manual wheelchair users

9.7.2 A gradient of 5% (1 in 20) should generally be regarded as a desirable maximum in most situations and 8% (1 in 12) should be considered the absolute maximum. There are locations where the terrain dictates that steeper gradients cannot reasonably be avoided. At these locations, local authorities need to provide a justification for proposing steeper gradients for active travel routes, as per section 3(6) of the Active Travel Act.

9.7.3 Steeper gradients can be managed by some wheelchair users, but only over very short distances (1m or less), for example on a short ramp. Even over these short distances the maximum gradient used should be no more than 10% (1 in 10).

9.7.4 Steep cambers and crossfalls are a problem for many people, including wheelchair users. Crossfalls should preferably be 2.5% (1 in 40) with a desirable maximum value of 3.3% (1 in 30) and an absolute maximum of 10% at crossings.

9.7.5 Flat landings or rest areas along gradients can provide useful, particularly for those using wheeled mobility aids. These are also important in providing a rest opportunity for those travelling uphill, as well as those travelling downhill to help avoid increasing speeds. Handrails should also be provided on both sides to aid users.

9.7.6 Steps without a ramp, or stepped ramps, should be avoided on active travel routes, as they are inaccessible for some users. Where alternatives are not available on existing routes, considerations are explored further within chapter 11.

9.8 Surface material for pedestrian routes

9.8.1 The choice of surface material is important to pedestrian comfort and can also contribute to the character of a street environment. Surfaces should be even, firm and slip resistant in wet and dry conditions. The maximum deviation in height under a 1.0m straight edge should not exceed 6mm.

9.8.2 Many blind and partially sighted people are not able to distinguish contrasting colour and tone. Footway materials should be consistent, avoiding the use of random patterns which have no meaning. Good contrast between pedestrian routes, cycle tracks and carriageways can help blind and partially sighted people to make sense of their environment.

9.8.3 It is vital that suitable tactile surfaces are provided, applicable to the context of the situation. Further detail on appropriate tactile paving options are provided within chapter 15.

9.8.4 Paving flags or block paving must be evenly laid; any unevenness can cause problems, particularly for some wheelchair users and some blind and partially sighted cane users. Cobblestones or setts should not be used unless they are flat, smooth and constructed within level tolerance.

9.9 Cyclists' needs

- 9.9.1 In this guidance, 'cyclist' is used as shorthand for anyone who uses a cycle, whatever the distance, speed or purpose of the journey, or the characteristics of the person or type of cycle.
- 9.9.2 Designs should meet the needs of everyone who cycles at any age or physical condition. Cycle routes should cater for a wide spectrum of people with different levels of confidence and experience; and those who use adapted cycles (see section 9.3 and figure 9.4).
- 9.9.3 Cyclists are at greater risk of injury than drivers. Cycle-only injuries are often a result of poorly maintained or managed routes, whereas two thirds of collisions involving another vehicle occur at junctions, which therefore need particular attention when designing routes. The presence of high speed, high volume traffic affects both safety and the comfort to the user. Routes must be wide enough so that cyclists are able to comfortably cycle without risk of conflict with other users both on and off road.
- 9.9.4 As with pedestrian routes, cycle routes should follow the 5 key principles introduced within section 9.1. This section explores considerations for cyclists under these 5 principles, before providing more specific user needs/considerations for cyclists.

Coherent (cyclists)

- 9.9.5 Cycle routes must form a coherent network; to achieve this:
- it must connect all the places cyclists want to start and finish their journeys with a route quality that is consistent and easy to navigate
 - 'end of route' signs should not be installed – cyclists should be shown how the route continues
 - abrupt changes in the level of provision for cyclists – such as a busy roundabout – will mean that a route becomes disjointed and is not suitable for all so will exclude some potential users

Direct (cyclists)

- 9.9.6 Routes for cyclists must provide the most direct and fastest route from origin to destination. In order to make cycling preferable to driving, and reduce the risk that cyclists will choose unsuitable routes, there must be route options that are at least as direct as those available for motor vehicles. Consideration of directness must include delays caused by the need to stop and give way at junctions or crossings.

Safe (cyclists)

9.9.7 Cycle routes and networks must not only improve cyclists' – and other road users' – safety, but also their perception of how safe the environment is. To help achieve this:

- consideration must be given to reducing the volumes and speeds of motor vehicles to acceptable levels, particularly when cyclists are expected to share the carriageway
- the need for cyclists to come into close proximity and conflict with motor traffic must be removed, particularly at junctions, where the majority of collisions occur
- complex layouts which require users to process large amounts of information should be avoided. Good network design should be self-explanatory and self-evident to all road users
- good quality surfaces are required, not least to prevent accidents and injuries

Figure 9.10 – Cycle track runs continuously through a side junction



Comfortable (cyclists)

9.9.8 To ensure acceptable levels of comfort for a cyclist, the following should be included:

- smooth surfaces
- minimal stopping and starting (e.g. priority over minor side road junctions)
- avoiding of the need to ascend or descend steep gradients (or, where unavoidable, suitable mitigation features considered within route design)
- use of design features which minimise risk of conflict with other users (e.g. separation of cyclists, pedestrians and motor vehicles with appropriate design widths for the route context)

Attractive (cyclists)

9.9.9 People cycling are more aware of the environment they are moving through than those in cars or other motor vehicles. The attractiveness of the route itself will therefore affect whether users choose to cycle. Routes should be appealing and be perceived as safe and usable, with the impact on pedestrians, including disabled people, considered at all stages of development. Often routes can be improved via implementation of measures that contribute to other aims, e.g. provision of planting that both increases attractiveness and acts as a form of sustainable drainage.

9.10 Creating opportunities for encouraging e-cycles

- 9.10.1 E-cycles provide battery power to drive the wheels in addition to the effort of the cyclist, up to a speed of 15.5mph. An e-cycle can greatly reduce the effort required to travel up gradients and increase acceptable distances, in comparison to a conventional cycle. This means e-cycles can significantly extend the distance that can reasonably be expected to be made by cycle and compare favourably to distances that are frequently made by car. With conventional cycles, fitness and age are important factors determining use, whereas e-cycles offer opportunities to introduce new user groups to cycling. E-cycles use cycle lanes, tracks and parking spaces in the same way as conventional cycles; however their use is currently limited to those aged 14 years and over.
- 9.10.2 E-cargo cycles are becoming more popular, particularly within city centre areas where they are used for parcel and food deliveries. E-cargo cycles offer a viable alternative to delivery vans, particularly in urban areas where destinations are concentrated and/or motor traffic restricted. Well designed cycle routes that provide adequate widths to accommodate e-cargo bikes will allow logistics and delivery companies the confidence to reduce their reliance on vans for urban deliveries. Further consideration is available in the Sustrans report [Reinventing transport planning for E-cargo bikes](#).
- 9.10.3 E-cycles have potential outside of urban centres by making trips between outlying villages and their nearest towns possible by cycling. E-cycles therefore offer a potential for modal shift across Wales, though high quality, safe infrastructure is still required. The potential carbon savings of e-cycles is considered in this [CRED report](#).
- 9.10.4 Consideration of facilities relating specifically to e-cycles (e.g. charging points) are described within chapter 14.

9.11 Dimensions of cycles commonly in use

- 9.11.1 Typical solo upright cycles for adults are around 1.8m in length and 650mm in width. Extra width is needed for moving cyclists; see paragraph 9.17 for this and other considerations regarding widths to accommodate moving cycles.
- 9.11.2 People using non-standard types and sizes of cycles should not be excluded from using cycle infrastructure through lack of consideration for their needs at the design stage. There are many types of cycle, (see figure 9.11) including:
- cycles with trailers
 - tricycles
 - tandems with two or more seats
 - inclusive cycles designed for disabled people e.g. quadricycles and hand cycles
 - recumbent cycles
 - cargo cycles (for carrying goods or children)
 - small-wheeled foldable cycles
- 9.11.3 Inclusive cycles are designed for disabled people and can be tricycles (both upright and recumbent), handcycles, tandems or upright cycles adapted to suit the rider's disability. Although the dimensions of these cycles varies, a 'Cycle Design Vehicle' has been defined which is an abstract composite of all the cycles that might reasonably use the cycle network. Designing the network around this design model ensures that it is accessible to all.

Figure 9.11 – Types of cycle with dimensions



9.11.4 Table 9.3 provides the key dimensions and minimum turning circles of different types of cycle. Turning circles are based on the space required to execute a full turn, the 'outer radius', and the space required to turn around a fixed object, the 'inner radius'. For solo upright cycles, the inner radius should be at least 850mm and outer radius 1.65m, although these will require the cyclist to be travelling very slowly, for example accessing cycle parking. Larger radii are necessary where cycles will be travelling at higher speeds.

Table 9.3 – Cycle and minimum turning radii

Type of cycle	Typical length (m)	Typical width (m)	Minimum turning circle (m)	
			Outer radius	Inner radius
Solo upright	1.8	0.65	1.65	0.85
Cycle plus 850mm wide trailer	2.7	0.85	2.65	1.5
Tandem	2.4	0.65	3.15	2.25
Cycle design vehicle	2.8 (max)	1.2 (max)	3.4 (max)	2.5m (3 and 4 wheel cycles)

9.12 Headroom for cycle routes

- 9.12.1 Cyclists require a minimum of 2.7m of headroom (CD 127, DMRB). This may be reduced to 2.4m where the obstruction is for less than 23m or 2.3m at instantaneous obstructions such as signs.
- 9.12.2 At existing structures, an absolute minimum of 2.2m may be acceptable, though in determining this, designers should consider the forward visibility of the underbridge offered by the vertical and horizontal geometry. Signs to TSGRD diagrams 530A and 530.2 should be used to warn of this low headroom, rather than ‘cyclists dismount’ signs, the use of which should be avoided on active travel routes.

Figure 9.12 – Low headroom signage (diagram 530A) and associated sign plate example



9.13 Typical cycling speeds

The speed of different people cycling can vary widely – ranging from walking pace to 25mph or more on steep, downhill gradients.

Table 9.4 – Typical speeds for cycling by type of user

User type	Typical desired speeds	Current approximate share of cycling
Child - school travel	7-15mph	10%
Adult with child - leisure	7-15mph	36%
Adult - shopping and other stop/start journeys	10-15mph	15%
Adult - commuting	10-20mph	39%

9.13.1 Although speeds do vary, the aim should always be to create facilities that suit as wide a range of people as possible, rather than providing ‘dual networks’ for novice and experienced cyclists. This can be done by creating facilities that enable people to travel at the speed they wish to, with sufficient space to overtake. Cycle traffic should preferably be separated from pedestrian traffic to avoid conflict and allow cyclists to travel at a comfortable speed. This is covered in more detail in chapter 11.2.

9.14 Visibility dimensions for cycle routes

9.14.1 Stopping Sight Distance (SSD) is the distance required for a rider to perceive, react and stop safely. It is measured in a straight line between two points at the centre line of the route, with the line of sight lying within the highway or cycle track boundary. SSDs for cyclists travelling at different speeds are given in table 9.5.

Table 9.5: Stopping site distance

Design speed (kph)	Minimum stopping sight distance (metres)
40	47
30	31
20	17

Object visibility

9.14.2 Object visibility should be available over the following envelope, as shown in figure 9.13. Designers should ensure that objects between the carriageway surface and a height of 2.4m are visible from an eye height in the range of 800mm to 2.2m. These values accommodate a range of cyclists including recumbent users, children and adults.

Figure 9.13 – Cyclists visibility envelope

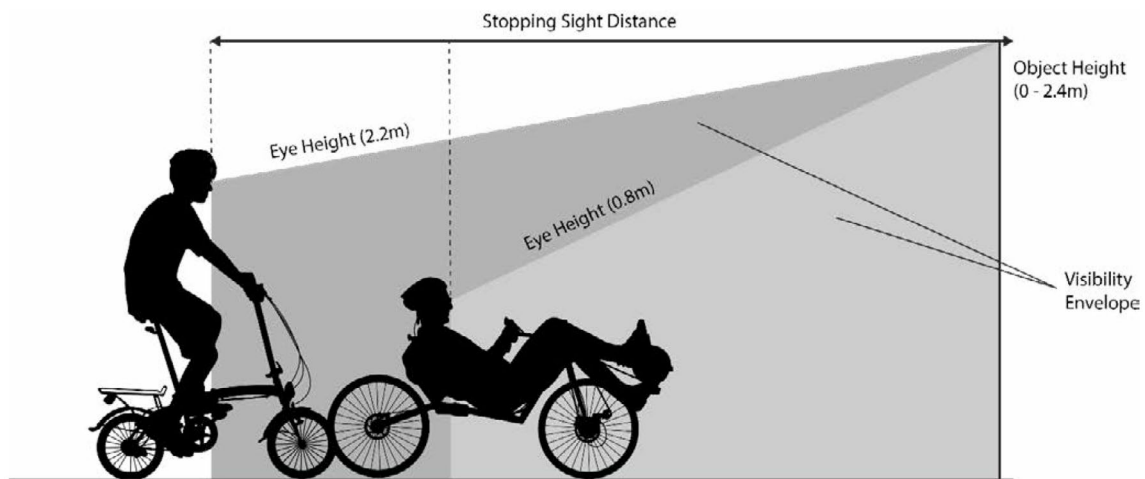

Visibility Splays

9.14.3 For crossing facilities shared with pedestrians, such as toucan, parallel or uncontrolled crossings on shared use routes, designers should refer to figures given within table 9.2 (pedestrian user needs).

9.14.4 Any crossing of a highway or junction between cycle routes should be located such that all users have full visibility as shown in with figure 9.14. 'X' distances are shown within table 9.6, with the 'Y' distance measured on the highway from the centre of the minor arm.

Figure 9.14 – Visibility splay

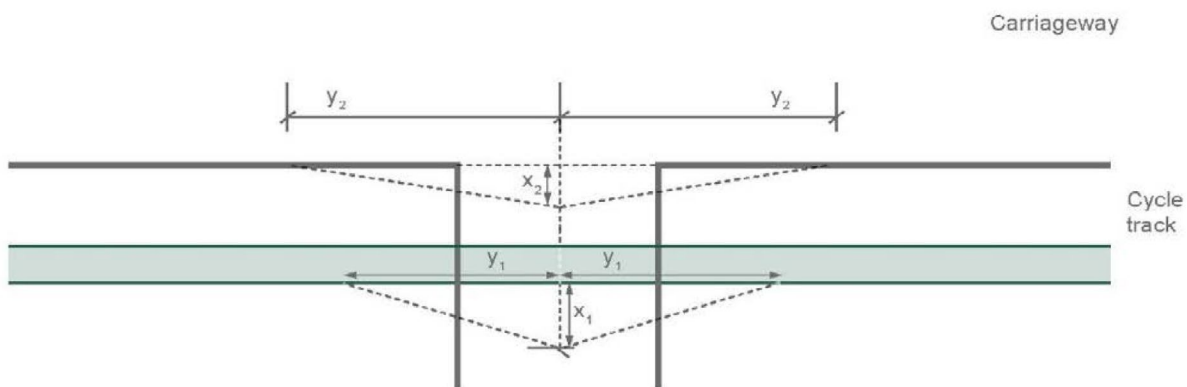

Table 9.6: X-distances for visibility splays for cycle traffic

Desirable minimum (m)	Absolute minimum (m)
4.5	2.4

- 9.14.5 The 'X' distances for cyclists equate to the eye heights for one or two cycle design vehicles (cycles located at the junction). The desirable minimum 'X' distance allows two users to observe the full 'Y' distance and both accept the gap in traffic. Designers should therefore seek to improve visibility along the 'Y' distance before reducing the 'X' distance.
- 9.14.6 For 'Y' distances, the major arm being joined may be a carriageway with adjacent footways, a bridleway or footpath, or another cycle track. The 'Y' distance on a junction of two cycle tracks is the same as the SSD on the major arm (see table 9.5 for SSD).
- 9.14.7 If there are objects such as walls or hedges that restrict visibility where an active travel route along a main road crosses side road entrances it is likely that drivers will edge forward and temporarily block the route while waiting to join the main road. Features that may reduce the visibility from junctions (either now or in the future) should therefore be avoided where possible at the early design stages for new routes.

9.15 Gradients on cycle routes

- 9.15.1 Ascending even short uphill gradients increases the effort and discomfort for cyclists considerably. Gradients are particularly difficult for less able cyclists, or people using adapted cycles, which tend to be heavier and offer limited ability for short-term increases in power. Downhill gradients can lead to rapid increase in speed, which increases the risk of loss of control (particularly for heavier cargo or e-cargo cycles), and increases the difference in cyclists speed relative to pedestrians.
- 9.15.2 Routes should therefore avoid the steepest gradients if there is a suitable alternative flatter route. The maximum desirable gradient depends on length. People are better able to tackle short steep gradients, but even relatively gentle gradients can become difficult if they are lengthy.
- 9.15.3 Table 9.7, derived from the Design Manual for Bicycle Traffic (CROW, Netherlands), shows the relationship between desirable maximum gradient and the length of the incline. On an existing steep slope, it may be possible to introduce zig-zag ramps or landings to reduce the gradient even though this will extend the length of the climb.

Table 9.7 – Relationship between gradient and length of incline

Gradient	Desirable maximum length of gradient (m)
2.0%	150
2.5%	100
3.0%	80
3.5%	60
4.0%	50
4.5%	40
5.0%	30

- 9.15.4 On uphill gradients cyclists' speeds will decline significantly below the 10-15mph that could be expected from most cyclists on a level gradient. At even relatively modest uphill gradients of 3% or so, the speed achieved by a cyclist could fall to the level – typically around 7mph – at which point the stability of the cycle is reduced. The additional space needed by slow moving cyclists should be considered where they share space with motor traffic or pedestrians.
- 9.15.5 On downhill gradients cyclists' speeds will rapidly increase, with a speed of 20-25mph easily achieved. Care should be taken to allow cyclists to maintain this momentum as much as possible, by increasing design speeds at the foot of slopes. Where space does not allow provision of wide lanes in both directions, it may be preferable to provide wide lanes or tracks for uphill cyclists. Downhill cyclists are more likely to be able to maintain a speed similar to general traffic and therefore may have less of a need for provision of cycle tracks or lanes.
- 9.15.6 Cycle tracks can be constructed with either a crossfall across the whole width or a central camber to help surface water to clear, but in either case the gradient should not exceed 2.5% as this could cause wheels to slide in icy conditions (and is in line with the desirable recommendations provided at 9.7.4 for pedestrians who may be crossing the track). Three and four-wheel cycles (and children in trailers) are particularly affected by variations in camber that can make steering more difficult and the riding experience uncomfortable. While superelevation is not typically required along a cycle route, negative camber that falls to the outside of a bend should be avoided.
- 9.15.7 Steps, or use of stepped ramps, should be avoided on active travel routes, as they require cyclists to dismount, and are therefore inaccessible. Where they are on existing routes, considerations are explored further within chapter 11.

9.16 Space required for cycling

9.16.1 Typically, cyclists move from side to side to maintain balance when in motion: these lateral movements increase as speeds diminish, for example when travelling uphill. At a speed of 7mph or above the space required by a cyclist is approximately 1.0m in width for the purposes of maintaining balance, i.e. around 200mm more than the width when stationary. This is known as the dynamic kinetic envelope.

Figure 9.15 – Space requirements for cycling

Minimum clearance (not regarded by all cyclists as safe - see text) between cyclist and overtaking traffic

0.85m < 20mph
1.05m = 30mph

Note: these measurements are taken between the motor vehicle and the cyclist not the dynamic envelope

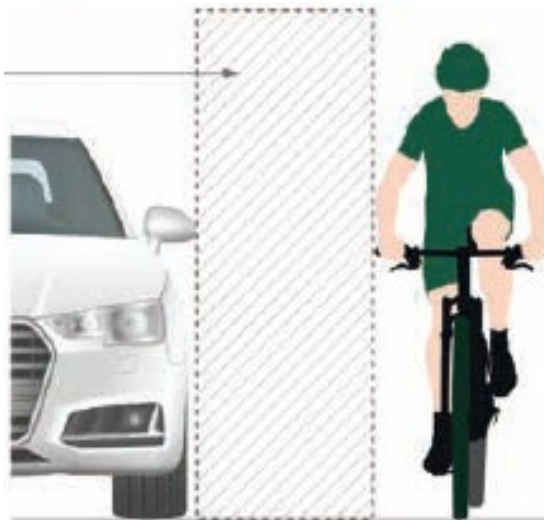

Design minimum safe passing distance (measured from outside of cyclist's dynamic envelope)	
20mph	1.0m
30mph	1.5m

9.16.2 The space required to cycle is normally more than the 1.0m dynamic kinetic envelope because it needs to include:

- wobble room, so that cyclists of all abilities feel they have the space to move comfortably
- cyclists may need to deviate from their path by around 500mm to avoid gullies or potholes at the edge of the carriageway
- additional clearance to the position, height, width and profile of any continuous or intermittent physical barriers around pedal height, such as full-height kerb-segregation or light segregation. Objects with a vertical profile need a wider clearance than rounded or sloping objects, and the risk of clipping a pedal is greater for higher kerbs
- clearance to any physical barriers at handle-bar height or above, typically walls, guardrail, sign or signal poles and lamp-posts

- separation from adjacent traffic lane(s) or, how close vehicles will come to encroaching on the cycling facility, which will be greater depending on the speed and width/type of vehicles moving alongside the cyclists
- separation from pedestrians on adjacent footways
- adequate separation from adjacent bus infrastructure; and
- allowances for the geometry of the lane or track-cyclists require greater widths on curves, such as where the lane or track deviates around parked cars, loading bays, bus stops, etc.

9.17 Cycle tracks and cycle lanes – usage and widths

- 9.17.1 A cycle track definition refers back to Schedule 329 of the Highways Act (1980). For ease of clarification within this document, cycle tracks refer to routes which are adjacent to the highway but separated by features such as a kerb, verge, level difference or material delineation.
- 9.17.2 Cycle lanes are defined within Schedule 1 of the Traffic Signs and General Regulations Directions (2016). A cycle lane is defined as part of a carriageway of a road reserved for pedal cycles which is separated from the rest of the carriageway, which may or may not be used by other vehicles (depending on the associated markings).
- 9.17.3 A recent study suggested that painted cycle lanes offer no reduction in injury risk compared to no cycling infrastructure, and that advisory cycle lanes increase the risk of injury. ([Adams & Aldred, 2020](#)).
- 9.17.4 In most circumstances, provision of a cycle track is the preferred approach – a cycle lane is only likely to be a suitable intervention for all users where 85th percentile traffic speeds are less than 20mph and traffic flows are less than 5000 passenger car units per day. Chapter 11 provides details on recommended provision for various scenarios.
- 9.17.5 Cycle route is a term used in generic contexts and can mean a cycle track, cycle lane, or a shared path, or a combination of several of these elements.
- 9.17.6 Table 9.8 shows the absolute and desirable minimum widths of different types of provision in relation to the peak hour flows. Designers should take into account future demand, as well as potential loss of widths of the useable track due to adjacent vertical features and drainage gullies as these will reduce the effective width.

Table 9.8 – Cycle route type and desirable/absolute minimum widths

Cycle route type	Direction	Peak hour cycle flow* (one-way or two-way depending on cycle route type)	Desirable minimum width (m)	Absolute minimum width at physical constraints (m)
Protected space for cycling (including light segregation, stepped cycle track, kerbed cycle track)	1 way	<200	2.0	1.5
		200 – 800	2.2	2.0
		>800	2.5	2.0
	2 way	<300	3.0	2.0
		>300 – 1000	3.0	2.5
		>1000	4.0	3.0
Cycle lane	1 way	All – cyclists able to use carriageway to overtake	2.0	1.5

*based on maximum expected future use

- 9.17.7 A clearance of 500mm between dynamic kinetic envelopes enables cyclists to pass or ride alongside one another comfortably and safely. Based on the typical dynamic kinetic envelope of 1.0m, this would mean that an effective width of 2.5m is required to permit safe overtaking or social cycling. A width of 2.0m allows these activities to take place with care and should therefore be regarded as a desirable minimum on tracks designed for one-way cycling (assuming flows of less than 200 in the peak hour). With a lane or track width of 2.5m, many adapted cycles cannot overtake or cannot be overtaken without difficulty. Therefore the absolute minimum figures should only be used where there is a physical constraint on the route.
- 9.17.8 When moving in opposing directions, there is a risk of head-on collisions, which can be severe if cyclists are moving at high speeds. At least 1.0m clearance between opposing flows of cyclists is recommended. This gives rise to a desirable minimum width requirement of 3.0m for two-way cycle tracks. This minimum width would allow overtaking or social cycling where there is a light flow in the opposing direction.
- 9.17.9 Shared footway/cycle surfaces are not generally recommended but can offer a practical solution in rural and suburban areas where pedestrian and cycle traffic is light. The network planning stages will help to assess options prior to design. A minimum width of 3.0m is recommended where pedestrians and cyclists use the same surface.
- 9.17.10 A minimum width of 1.5m is required between bollards, chicane barriers or at gates to accommodate the full range of cycles. Gates should be avoided on cycle routes and 'kissing gates' must not be used.

9.17.11 If a cycle track cannot be provided and conditions are suitable for cycle lanes (see chapter 11 section 11.4), a width of 2.0m will accommodate all cycles and enable riders to avoid gullies and be a comfortable distance from adjacent motor traffic. Narrow cycle lanes (<1.5m) must not be used as they can place cyclists in greater danger.

9.17.12 As with any form of transport, people cycling may be travelling with someone else. Many people will wish to be able to cycle in comfort side by side, particularly in the case of parents accompanying children, or when they wish to safely overtake another cyclist. If cyclists cannot overtake slower riders within a cycle track or a cycle lane they may put themselves and others at risk by cycling in an adjacent all-purpose carriageway lane.

9.18 Additional width adjacent to vertical features

9.18.1 The recommended additional space (measured from the wheel) to provide sufficient clearance to an adjacent upstand or vertical structure parallel to a cycle track/lane is:

- kerb up to 150mm high: add 200mm
- vertical feature 150-600mm high: add 250mm
- vertical feature above 600mm high: add 500mm

9.19 Additional width adjacent to carriageway

9.19.1 The buffer or verge strip between the cycle track and carriageway can vary in width and can contribute positively to the quality of the streetscape with the potential to accommodate planting and sustainable drainage. If the buffer is of a hard surface and of sufficient widths, it can provide a place for pedestrians to wait and cross. A width of 1.5m will be sufficient to accommodate users of wheelchairs and mobility scooters¹.

9.19.2 The buffer or verge also helps protect cyclists from the air turbulence created by passing motor traffic and from debris that may be thrown from the carriageway.

9.19.3 Minimum recommended horizontal separation between carriageway and cycle tracks for the speed limit is shown in table 9.9.

Table 9.9 – Speed limit and desirable/absolute standards

Speed limit (mph)	Desirable minimum horizontal separation (m)	Absolute minimum horizontal separation
30	0.5	0
40	1.0	0.5
50	2.0	1.5
60	2.5	2.5
70	3.5	3.0

(Separation strip should be at least 500mm alongside kerbside parking and 1.5m where wheelchair access is required).

¹ *Inclusive Mobility – A Guide to best Practice on Access to Pedestrian and Transport Infrastructure, DfT, 2002*

- 9.19.4 To enable disabled users to cross carriageways/tracks, regular dropped kerbs should be provided along the buffer strip. Alternatively, gaps in the strip should be provided where the cycle track is at carriageway level. Tactile paving should be provided following the principles of [Guidance on the Use of Tactile Paving Surfaces](#).
- 9.19.5 Gaps in the buffer strip at side road junctions are also needed to enable cyclists to enter and leave the protected cycle track space.

9.20 Width considerations for on-carriageway cycling

- 9.20.1 In places where cyclists can be expected to share the road with motor vehicles, the width of the road profile has a profound effect on cyclists' comfort. Cyclists may feel uncomfortable if road conditions create a sense that they are impeding motor traffic, while drivers may become impatient if they cannot easily overtake. This may in turn lead to hazardous and uncomfortable overtaking manoeuvres.
- 9.20.2 Designers should always be aware of the effect of their lane and carriageway width choices on cyclists, even if they are designing a route that has not been identified as an active travel route. The obligation for highway authorities to consider cyclists when discharging their general functions is discussed further in chapter 11.

On carriageway cycling

- 9.20.3 National Standards Cycle Training in Wales provides three levels of skills, from basic cycle handling at level 1 to riding on busy roads and junctions at level 3.
- 9.20.4 The training recommends cyclists to adopt two main riding positions when riding on carriageways – the primary, also known as 'follow-me', and secondary, also known as 'pass-me' positions (see figure 9.16). Designers need to be aware of these riding positions and design on-carriageway cycle routes with them in mind. Chapter 11 provides guidance on when on-carriageway cycling is acceptable.

Figure 9.16 – Primary and secondary road positions

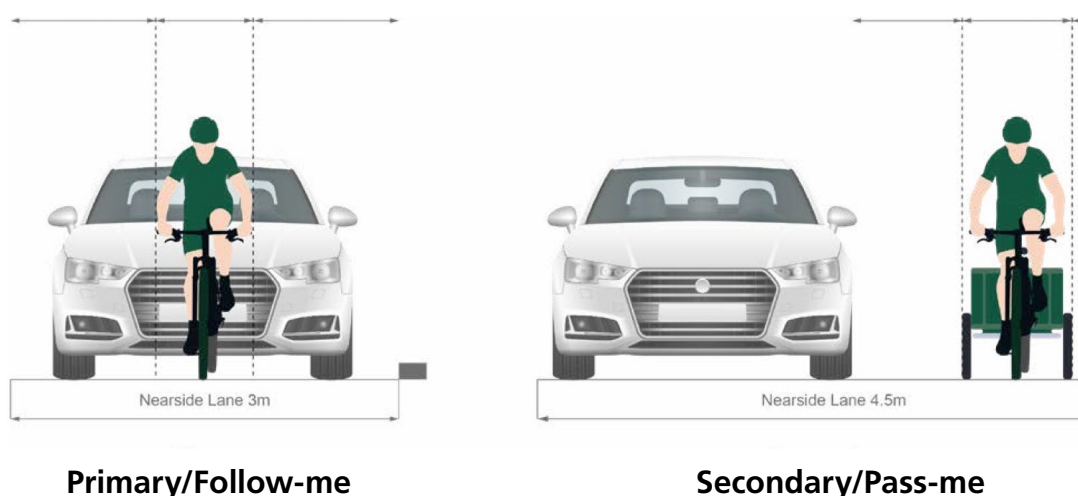

- 9.20.5 As part of National Standards Cycle Training, cyclists are advised to adopt the primary/follow-me position, riding in the centre of their traffic lane in situations where they can keep up with other traffic, when no traffic is trying to overtake them, or when overtaking would be unsafe (including at the approaches to junctions, on narrow sections of road, or when approaching junctions or corners). The primary position maximises a cyclists' ability to see and be seen by other road users, whilst reducing the risk of inappropriate overtaking manoeuvres, particularly in safety-critical situations.
- 9.20.6 Cyclists are advised to adopt the secondary/pass-me position when motor vehicles wish to overtake them, providing it is safe for a cyclist to do so. This means a cyclist positioning at least 1m to the left of the traffic stream but no less than 500mm from the kerb or from any parked car doors. This position ensures that a cyclist is far enough out to be able to avoid drains or debris but can also move in either direction to avoid surface hazards.
- 9.20.7 Following this advice can be safer than other road positioning, but those who have not received training may not be familiar with it and less experienced cyclists may be nervous to adopt it. It is therefore only recommended to design active travel routes that depend on cyclists taking the primary position on streets where motor traffic volumes and speeds are very low (see chapter 11 to establish most appropriate provision for the route context).

Overtaking clearance to passing vehicles

- 9.20.8 The minimum clearance between a moving motor vehicle and the outside of the dynamic kinetic envelope of a cyclist should be 1.0m where the motor vehicle is travelling at 20mph or less, and 1.4m at 30mph or more. More clearance is needed where a high proportion of traffic is made up of buses and HGVs, and any measurement should be taken to the furthest side extremity of the vehicle. This has implications for the design of pinch points and for the width of general traffic lanes when cyclists are sharing carriageways.

9.21 General lane widths on carriageways

- 9.21.1 Traffic lane widths of less than 3.0m or more than 4.0m should preferably be used. Lane widths in the critical range of 3.2m to 3.9m should be avoided unless motor traffic flows are sufficiently low (less than 5000 AADT and ideally below 2500) that drivers can cross easily into the opposing carriageway to overtake cyclists.
- 9.21.2 The effect on typical carriageway profiles is as follows (in streets with car parking the dimensions given below are based on the dimensions between parking bays).

Wide streets – 9.0m minimum two-way carriageway

- 9.21.3 A 9.0m carriageway provides adequate space for drivers to overtake cyclists comfortably, however, speeds can be high. Within the overall carriageway width available consideration should be given to provision the of cycle lanes (or adjacent tracks), which should be wider where speed limits are higher.

Critical width streets – 7.3m two-way carriageway

- 9.21.4 The 7.3m carriageway has been the default standard in the UK for many years. A 7.3m width (2 x 3.65m lanes) generally provides space for a driver to overtake a cyclist without crossing the centre line, but does not allow for any safety margin for the comfort and protection of a cyclist. Carriageways with lane widths between 3.2 and 3.9m should therefore be avoided for active travel routes, unless traffic flows are low and sightlines are good enough to permit safe overtaking.
- 9.21.5 Designers should only use 7.3m wide carriageways for active travel routes when cyclists are accommodated off the carriageway or traffic volumes are low. Providing narrow (<1.5m) advisory cycle lanes within a 7.3m carriageway is not an acceptable or recommended intervention.
- 9.21.6 Where an existing 7.3m carriageway is being considered as an active travel route, it may be possible to make conditions more suitable for cycling by reducing the speed and volume of motor traffic or making the carriageway into a one-way road with a two-way cycle track (4.0m plus 3.3m traffic lane), or if conditions are suitable for a mandatory cycle lane (see chapter 9.18) via combination of 2.0m lanes and removal of centre line.

Narrow streets - 6.0m two-way carriageway

- 9.21.7 Narrow streets are objectively safer for cyclists as drivers are less likely to be able to overtake. However, such streets should be short, traffic calmed, and designed to make it clear that cyclists have priority. Less confident cyclists may feel uncomfortable being assertive in their use of the space.

9.22 Width at pinch points

- 9.22.1 It is important to ensure that chicanes and pinch-points have a bypass for cycles or are designed in such a way that cyclists are neither squeezed nor intimidated by motor vehicles. The preferred option is to provide enough width so that a cyclist can remain in the secondary/pass-me position and be overtaken safely. When speeds are low, the alternative is for cyclists to be automatically placed in the primary position by making the carriageway width less than 3.0m.

Table 9.10 – Speed limits and lane widths

Speed limit	Lane width (m)	
	<5% HGVs	>5% HGVs
20mph	2.5 maximum	3.0 maximum ¹
30mph or above	4.0 minimum	4.0 minimum ²

1. 3.0m maybe used if frequent traffic calming measures are present along the length of road
 2. Where 85th percentile speeds exceed 30mph, this should be increased to 4.5m

9.23 Surfaces for cycle routes

- 9.23.1 In comparison to motor traffic, cyclists are particularly susceptible to uneven or hazardous road surfaces, such as potholes, ruts, poorly maintained ironwork or slippery surfaces. Many cycle crashes involve no other vehicle and are due to poor surface conditions. Adverse or excessive camber is particularly difficult for users of three-wheel cycles.
- 9.23.2 Rough surfaces increase the effort required to cycle and reduce comfort. Routes for cyclists should be machine laid to offer a surface that is as smooth (or smoother) than a carriageway. Routes near vegetation should be constructed with a properly drained base course and designed to prevent root damage. Routine sweeping, vegetation clearance and winter maintenance should be undertaken on all active travel routes, whether on or off-carriageway (see chapter 15).



Chapter 10: Network planning and map preparation

This chapter sets out the value and process of producing the active travel network map (ATNM). It includes sections on the evidence base required for planning routes and how walking and cycling networks should be developed, as well as the audit process, prioritisation and submission of the maps.

Key areas for consideration include:

- how to develop walking and cycling network plans
- the inclusion of all schools, major retail and employment sites along with links to the nearest residential areas
- use of the audit tools and how to assess existing and future routes
- preparing, submitting for approval and publishing the ATNM
- prioritisation of the routes on the ATNM

10.1 Introduction

10.1.1 Information relating to the legislation and process for producing and submitting the ATNM is described in chapter 4. The act requires existing and future routes to be mapped and they must be reviewed every 3 years. These routes must connect to destinations and could be on road, shared, separated, or motor-traffic free, such as greenways and routes through public spaces. Routes can be for walkers or cyclists, or both. Maps are also to show crossing points and the facilities that exist to support active travel on these routes, such as parking, shelters & storage and public toilets. Other facilities that could be usefully shown on the map include: seating, cycle hire locations and e-cycle charging points.

10.1.2 For clarity of presentation, separate methods are given for the initial steps in planning for walking and cycling networks, but in practice data gathering and public consultation is common to both modes. Generally acceptable travel distances for people using both modes (including consideration for increasingly popular e-cycle) are set out chapter 4. Authorities should consider when to carry out the planning tasks separately for walking and cycling, and when to deal with both modes together. Both modal networks should be ambitious and developed according to evidence based potential demand for active travel routes.

Existing infrastructure

10.1.3 Network planning needs to be adaptable to settlements of different sizes and demographics, which will in turn impact on the range of data required to feed in to the process.

- 10.1.4 Routes connecting to, and within settlements have typically evolved over a long period of time and may not always meet modern design standards. Footways adjacent to roads, as well footpaths away from roads, mean that in many places there is already a comprehensive network to accommodate most pedestrian trips. However, the quality can often be improved to make places that are safer and more accessible to all and thereby encourage active travel to and within areas that attract lots of short journeys.
- 10.1.5 Cycling infrastructure is usually based around the development of route networks covering a whole town or city. Design standards have undergone considerable review over the last decade, and as a result some older infrastructure is often not up to the standard that is known to encourage higher levels of use.

Engagement

- 10.1.6 The ATNM development process requires local authorities to engage with those needed to make the networks a reality – politicians, engineers, funding bodies and the public, as well as partners in health, education, commercial and the voluntary sector. Engagement helps to foster a sense of ownership of the plan both within the local authority, with users and the wider community.
- 10.1.7 The ATNM is critical to the later more detailed design of route sections by providing the designer with an understanding of the context of a link or junction and its function with respect to the overall network.
- 10.1.8 The ATNM enables future improvement programmes to be planned, prioritised and managed. This represents a shift from ad-hoc opportunistic provision for cycling and walking, instead working towards the development of a logical and comprehensive network for active travel.
- 10.1.9 Local user knowledge is a key source of information and inputs from relevant stakeholders should be sought at all stages of the process using the techniques described in chapter 8 and the processes described in chapter 5.
- 10.1.10 Welsh Government provides a mapping system which local authorities must use to plot and show their ATNMs. The system also facilitates the process of submitting maps for Ministerial approval as described in chapter 4 and within this section. The mapping system is hosted on [DataMapWales](#)
- 10.1.11 Figure 10.1 highlights the key stages and processes that are required to develop an active travel network and the processes involved to get the maps approved.

Figure 10.1 – Network planning and map preparation flowchart

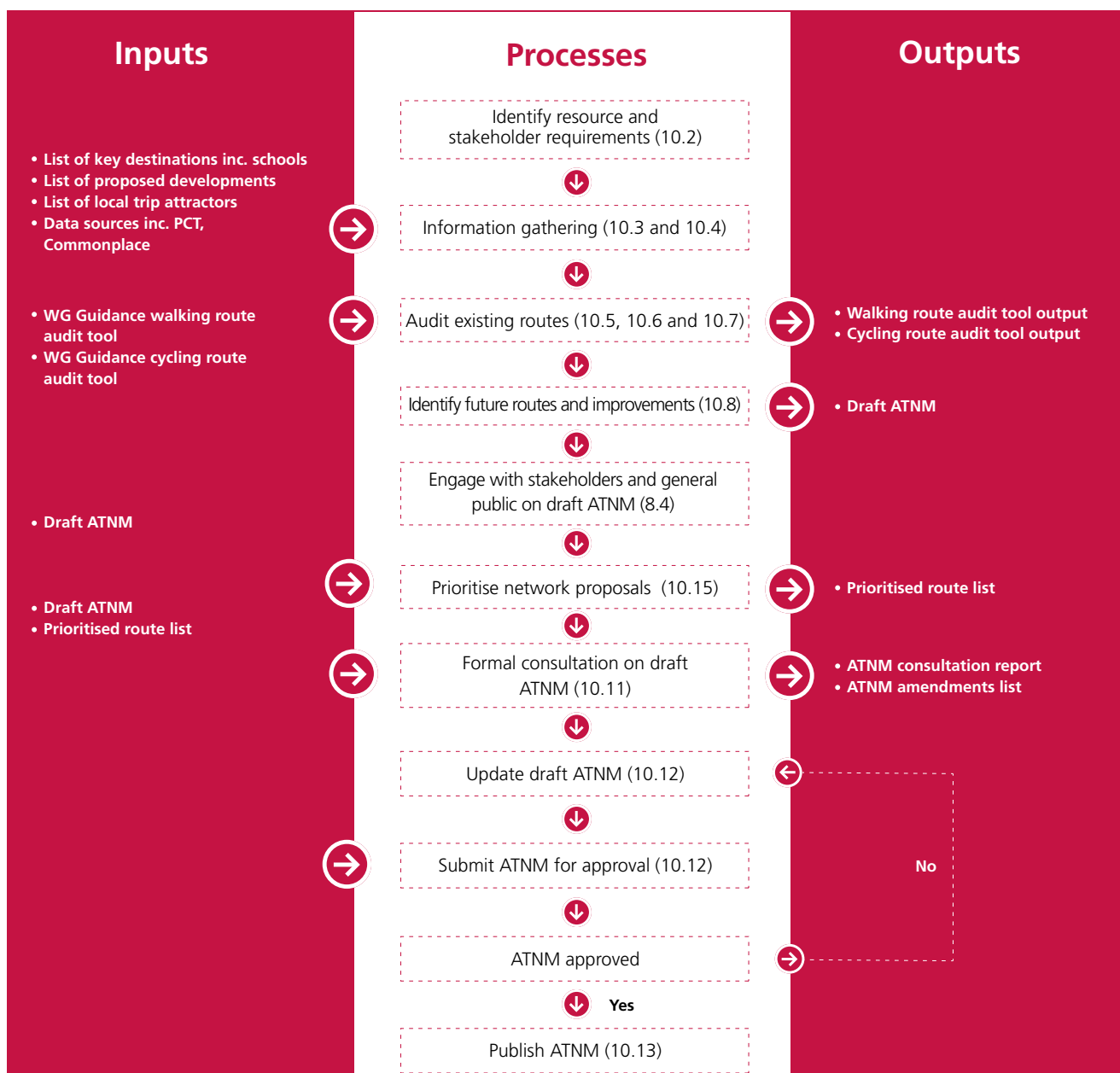

10.2 Information gathering and ATNM integration with policies, plans, programmes and infrastructure

10.2.1 Integration is key to the successful delivery of active travel networks. The programme of active travel infrastructure improvements needs to be integrated with existing functions of the urban network, and with other strategic plans and traffic management measures. The ATNMs are intended to form part of strategic local transport and land use plans, and to provide evidence for funding applications and for developing work programmes.

- 10.2.2 Research has shown that good quality routes, “complemented by other measures such as ample cycle parking, integration with public transport, the education and training of cyclists and motorists, and a wide range of promotional events intended to generate enthusiasm and wide public support for cycling” are integral to achieving high levels of walking and cycling¹. The most successful infrastructure is delivered within a wider programme that includes political commitment, skilled delivery teams, engagement, encouragement, monitoring and promotion.
- 10.2.3 This is an opportunity to consider all relevant local authority plans, and how they will come together to improve rates of walking and cycling across the county. Individual projects that were intended for delivery along the same route could be rationalised into a single scheme. The ATNM can then indicate where planned interventions might contradict each other or render schemes obsolete (for example, plans to restore gates on a footpath, which is also targeted to be turned into a cycle path with no gates). Particular attention should be paid to plans that will lead to changes in travel patterns, such changes afford significant opportunities for modal shift if appropriate infrastructure is available.
- 10.2.4 Local authorities shall highlight key destination points on their ATNM as this provides a focus for the network mapping with the aim of facilitating journeys to these locations. These also provide reference points for map users, an outline list of destinations to be considered is included within Appendix J.
- 10.2.5 Plans for new schools, new housing developments and/or new workplaces need to be a major consideration in creating and reviewing the ATNM, and evidence of this having been done should be provided when the ATNM is submitted for approval by Ministers.
- 10.2.6 The documents, plans, audits and other sources of information to consider in this process should as a minimum include:
- strategic development plans
 - local development plans (and supplementary planning guidance)
 - local or regional transport plans
 - rights of way improvement plans; and
 - Wales Transport Strategy and National Transport Finance Plan
- 10.2.7 It could also include other appropriate sources such as:
- local road safety plans and strategies
 - local and adjacent counties well-being plans
 - additional proposals for land-use, including housing/regeneration/commercial/industrial/education/green spaces and other relevant developments
 - For local authorities which border England, neighbouring authorities’ Local Cycling and Walking Infrastructure Plans may also be a useful source.

1

Pucher & Buehler, 2008, pp 495

- 10.2.8 This list is not exhaustive, and some of the plans mentioned above will not be relevant for all local authorities. The key point integration, is to draw together existing plans and look for ways to maximise benefits across different policy objectives and to minimise duplication of effort where work has already been undertaken, including:
- Modal integration: When measures have been considered for one transport mode, the consequences for other transport modes may become clearer. This integration is of most relevance where the different transport modes interact with one another such as at junctions and interchanges.
 - Land use integration: The effectiveness of the ATNM can be reinforced through integration with land use policy that creates developments that are conducive to active travel, and through a range of measures to encourage active travel as part of healthy lifestyles.
- 10.2.9 In the majority of designated localities under the act, local authorities will be able to use previous iterations of their ATNM as a starting point for the next 3-yearly review process. Any review must still consider relevant processes outlined within this chapter, and should be particularly mindful of:
- Emerging transport research and recommendations that have been introduced since the previous iteration of the network review (e.g. updates to design standards)
 - built environment changes that directly influence the design of the route, e.g. highway infrastructure implemented since the previous iteration along the alignment
 - local context changes that have indirectly influenced route usage along the alignment (e.g. a nearby supermarket or modal filter that has significantly increased or reduced flows)
 - updates to planned future developments that may influence uptake of active travel, for example a new housing development identified on an updated Local Development Plan
 - updates to any other national, regional or local plans, policies, programmes and infrastructure
 - any issues/suggestions highlighted via the engagement process
- 10.2.10 The ATNM enables authorities to consider potential sources of funds and make efficiencies by using overlaps with programmes across departments. For example, new pedestrian and cycle crossings could be installed as part of a road safety junction improvement scheme.
- 10.2.11 The ATNM may also highlight potential for delivery of active travel schemes through non-highway functions, such as economic development schemes, public realm and environmental management projects and new developments, including developer contributions (S278, S106 agreements and Community Infrastructure Levy funding).
- 10.2.12 Planning and Development Control officers should take the ATNM into account when considering planning applications, where existing or future routes pass through the site, see Planning sections in chapter 4 and chapter 7 for further details.

10.2.13 Whilst the focus of the ATNM is on designated settlements within a local authority, as required by the Active Travel Act, the principles underpinning active travel route planning are also relevant and applicable in smaller towns and villages. Planning Policy Wales 11 states, “in rural areas most new development should be located in settlements which have relatively good accessibility by non-car modes when compared to the rural area as a whole. Development in these areas should embrace the national sustainable placemaking outcomes, and, where possible, offer good active travel connections to the centres of settlements to reduce the need to travel by car for local journeys”.

10.3 Network planning for walking

Overview

10.3.1 There is usually already an extensive network of routes to accommodate most pedestrian journeys and the process starts by engaging with stakeholders and the public and reviewing existing routes. The role of pedestrian network planning for utility trips in built-up areas is to identify and prioritise improvements to make walking easier, safer and more attractive. An overview of the process is summarised in the flow chart in figure 10.2.

Walking networks stage 1 – Information gathering

10.3.2 This process starts by identifying where local short trips are taking place, and to gather and analyse any data that is available about the pattern and frequency of the trips. The initial analysis and local engagement undertaken when looking at existing routes may help to identify local barriers to walking. Although specific data on pedestrian journeys may be scant, there may be more general information about local trip patterns such as Census Journey to Work data and school travel plan data, as well as cordon counts.

Walking networks stage 2 – Identify and map key walking trip attractors

10.3.3 This stage aids the further development of ideas through mapping the location of local trip attractors and considering their catchments, including the potential impact of new development proposals on local travel patterns. It must include all schools and other examples of destination points that may be considered key walking trip attractors (town centre, stadia, rail stations etc.) are described within chapter 12.

Walking networks stage 3 – Identify and map key barriers to walking

10.3.4 By mapping the main barriers to walking, such as main roads, rivers or railways, this stage then involves the identification of ‘funnel routes’ which are key locations where pedestrian movements become concentrated.

Walking networks stage 4a – Identify and map potential linear walking routes

10.3.5 Three main types of linear routes:

- Type A – Routes to key clusters of destinations (i.e. town or city centres or major public transport interchanges)

Step A1 – Identify clusters of key destinations

Step A2 – identify key routes to these key clusters

Figure 10.2 – Network planning for walking



- Type B – funnel routes

Step B1 – identify key funnel routes (i.e. across or under railway) where there is likely to be high concentrations of users in a confined area and it's the only route available (although a review should be undertaken to assess if additional crossings or routes are needed)

- Type C – other linear routes

Step C1 – identify other key linear routes, such as high streets, district centres and routes to schools and public transport facilities (bus stops)

Walking Networks Stage 4b – Identify and map area based walking treatments

10.3.6 Areas include:

- identify schools within residential areas which are bounded by barriers, eg. main roads/railway lines
- map the residential areas as area based treatments so that area looked at a whole rather than just one or two key routes – potential interventions could be Low traffic neighbourhoods, modal filters, filtered permeability etc
- identify key connections between area based treatments to reduce severance of the barrier and to provide connections between areas

Walking networks stage 4c – Identify and map new walking links

10.3.7 A further consideration at this stage is whether there are existing desire lines with no formal provision at all (e.g. shortcuts across wasteland or car parks), and any forthcoming new developments that might alter local travel patterns and require new routes.

10.3.8 Pedestrian desire lines that are not facilitated by a suitable pedestrian facility can be identified from several sources, including:

- holding community workshops and requests from the public, local elected members and key stakeholders; Undertaking video monitoring to track pedestrian movements away from dedicated facilities
- evidence of worn pathways across grassed areas (desire lines), which may be noted from the on-site auditing of existing pedestrian routes; and
- analysis of barriers can highlight where facilities such as new crossing points and bridges could potentially accommodate a high number of pedestrian trips, with demand currently suppressed by the limited number of route options

10.3.9 Overlay mapping for Stages 2-4, this involves overlaying all the information gathered onto a map. GIS provides one of the easiest ways to combine the various data sources and present the spatial information. This stage is critical and involves translating the information above into actual routes. Local authorities should aim to make as much use as possible of existing infrastructure and any new infrastructure that is planned.

Stage 5 – Audit the routes

- 10.3.10 The next stages on route audit and assessment are included in section 10.5 following the network planning for cycling stages. Further details on the process for auditing the routes can be found in Appendix H.
- 10.3.11 Public and stakeholder engagement (see chapter 8) is an important element throughout these stages, enabling planners and route auditors to benefit from local knowledge about barriers and opportunities, and to get an understanding of the relative importance of different issues and potential support/opposition for interventions.

10.4 Network planning for cycling

Overview

- 10.4.1 The principles of network planning for cycling are to plan for routes which are continuous and cohesive, linking all key destinations within the locality as a complete journey so that cyclists can travel seamlessly on good quality infrastructure. Figure 10.4 outlines the process for creating the cycle network.

Mesh density

- 10.4.2 If a cycle network is viewed as a grid or mesh that is laid across an area, and the existing and future routes are the lines of the mesh, then the density can be measured by the distance (typically direct alignment) between those routes. This distance between routes is referred to as the “mesh width” for the basis of network planning.
- 10.4.3 Mesh density (as shown in figure 10.3) can be used to analyse the coverage of existing (and future) cycle routes in order to help identify where there are gaps. It is a simple analysis of the length of cycle route within each kilometre square.

Figure 10.3 – Example of mesh density analysis from [DataMapWales](#)

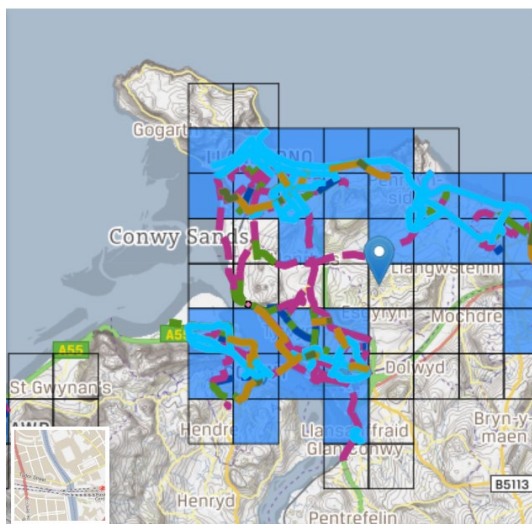

10.4.4 Cycling networks should ultimately be designed to have a mesh width of around 250m in central areas, with a wider mesh width of 500m in outer suburbs where the density of development is lower. It is accepted that this will require more than one planning cycle and shall be achieved by the third time the maps are submitted to Welsh Ministers, with clear progress evidenced at the interim cycle (2021). Physical barriers such as hills, rivers and railway lines may affect the overall mesh density but the ATNM should include any viable opportunities to address these.

Basic network

- 10.4.5 These existing and planned routes will also be supported by a basic network made up of the existing roads within a settlement, i.e. residential access roads and quieter streets where the speed and volume of traffic allows active travellers to share space with motor vehicles without fear of collision (see table 11.2 in chapter 11).
- 10.4.6 The basic network consists of not only designated cycle routes but also the local road network where conditions meet the standards set out in this guidance as being suitable for cycling. Local authorities shall make use of the cycle route audit tool (Appendix H) to assess the appropriateness of designating infrastructure as part of the basic network.

Figure 10.4 – Network planning for cycling

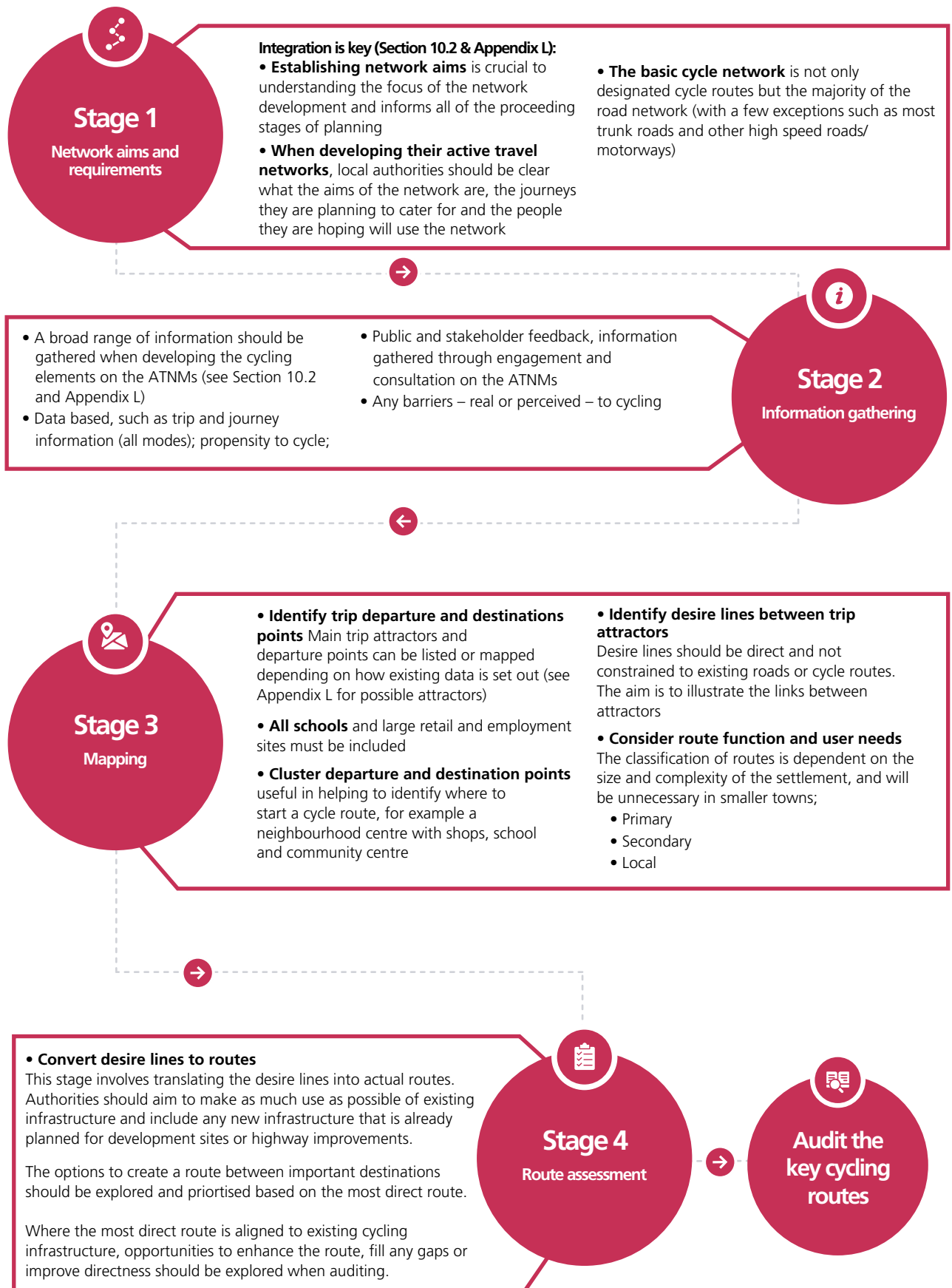

Cycling networks stage 1 – Network aims and requirements

- 10.4.7 Establishing aims for the network provides a focus for the network development and informs the following stages. Networks must aim to displace car journeys to achieve modal shift (see Llwybr Newydd in chapter 3) and include connections to schools, major retail and employment sites along with links to the nearest residential area. Beyond this, local authorities may wish to focus initially on serving key areas (such as links to a town centre) or types of journeys, such as commuting as a stepping stone towards achieving an overall network within 15 years. Being explicit about these aims will be useful for explaining to the public why some routes may have been prioritised over others that have popular appeal but do not serve a strategic aim, for example.
- 10.4.8 The five core principles to creating cycle networks are introduced and described in chapter 9. Routes should be:
- coherent
 - direct
 - safe
 - comfortable
 - attractive
- 10.4.9 The first two of these factors (i.e. coherence, directness) are of importance in the planning of the overall cycle network, whereas safety, comfort and attractiveness are particularly important in scheme design. Safety and attractiveness are relevant in network planning, but many safety, attractiveness and comfort issues can be addressed in detail through careful considered design.
- 10.4.10 The relevance of each of these factors in network planning is set out in table 10.2. Further details of appropriate design solutions can be found in chapter 11 and chapter 12.

Table 10.2 – Principle and key requirement

Principle	Key requirement
Coherent	<ul style="list-style-type: none"> • users should be able to start their journey where they live and reach their destination, whilst easily being able to join other routes on the network • routes should be easy to navigate for non-local users • routes should provide a mesh-density width of 250m in central areas
Direct	<ul style="list-style-type: none"> • routes should be as direct as possible between start and end points • the number of times an active user has to stop or give way should be minimised • time delay at junctions should be minimised • where possible, routes should avoid steep gradients
Safe	<ul style="list-style-type: none"> • routes should reduce the risk of conflict with crossing or adjacent traffic (e.g. via separation of users) • routes should avoid the need to share the carriageway with high volumes of motor traffic • routes should be easy to follow • routes should consider and reduce risk from kerbside activity • routes should include evasion room and avoid any unnecessary hazards • routes must consider all user demands
Comfortable	<ul style="list-style-type: none"> • routes must provide effective width without conflict with other users or modes • routes should provide separation from traffic, fumes and noise
Attractive	<ul style="list-style-type: none"> • routes should be overlooked and not isolated • appropriate related facilities (e.g. cycle parking, charging locations) should be provided at key destination points along the route during the planning stage

10.4.11 Different levels of provision would be expected on primary routes compared to the routes which typically make up the basic network (section 10.4.5 and 11.6) but the principle means that authorities should consider the safety of cyclists on most streets with regard to meeting the conditions for safe and comfortable cycling described in table 11.2. On trunk and other main roads, additional measures will be needed on links and junctions to make them safe enough to be included in the ATNM.

Cycling network stage 2 – Information gathering

10.4.12 A broad range of information should be gathered when developing the cycling elements on the ATNM, including data based and public engagement and stakeholder feedback. The level for this will depend to some extent on the size of the settlement, but collecting quality information is likely to increase the quality of the final network and therefore the take-up of active travel.

10.4.13 Public and stakeholder information should be obtained on:

- the journeys that people currently make (by all modes of transport)
- their trip departure and destination points
- the barriers they perceive to cycling or cycling more often
- their views on existing routes; and
- their requests for improvements and potential new routes

- 10.4.14 This information can be gathered through a variety of means including surveys, workshops, social media and exhibitions, both online and in-person. Further details and recommendations for engagement can be found in chapter 8.
- 10.4.15 There is a broad range of publicly available data which can usefully input into the development of an ATNM, the key data sets are included in section 10.2 above with further details in Appendix J. Launched in Wales in Spring 2018, the Propensity to Cycle Tool offers an easy way to look at local commuter trip patterns and also includes an assignment function that maps the trips to the local network (see www.pct.bike/). The tool also considers the propensity of cross-border trips between local authorities and to/from neighbouring English counties.
- 10.4.16 Where necessary local authorities may need to carry out additional cycle and traffic counts or speed surveys on specific streets or routes where no data already exists. This needs to be used in the context of the existing and envisaged use by motor vehicles and cyclists and can also be used for future monitoring of the impact of improvements (see chapter 16).
- 10.4.17 Collision data can be used, however, care needs to be taken to ensure that seemingly 'safe' routes with low casualty levels are not actually heavily trafficked routes that most cyclists avoid.

Cycling Network Stage 3 – Mapping

- 10.4.18 Once the relevant information has been gathered the mapping stage can be undertaken. The mapping stage should be developed through a process of layering relevant information from various sources as listed in Appendix J (including reference to other key policies and programmes) and is most easily done using GIS.
- 10.4.19 The mapping stage involves the following steps:
- map existing and future departure
 - plot links between them
 - designate route type

Map trip departure and destination points

- 10.4.20 Trip origin points are usually the main residential areas of the settlement. Depending on its size and the required density of the network, the departure points can be clustered – see below.
- 10.4.21 Trip destination points generally cover all of the buildings and amenities that might attract existing and potential cyclists and the routes to/from them must connect to a suitable location at the destination, e.g. front entrance or suitable cycle parking provision, so a whole journey can be made.
- 10.4.22 For the Active Travel Act the identification of important local departure and destination points will need to be completed as part of the production of the ATNM and should include all schools, town centres, public transport interchanges, major employment sites and others as described in 10.2 and Appendix J. New developments should also be considered.

10.4.23 Local authorities shall also consider destination and departure points in neighbouring local authorities where active travel is a viable transport option between different local authority areas. Wherever possible settlements in neighbouring local authorities should be connected through the active travel networks, which should be developed through collaborative working.

Clustering of departure and destination points

10.4.24 Once all existing and proposed departure and destination points have been mapped they will usually need to be clustered to reduce the complexity of identifying desire lines. The clustering will depend on the size of the settlement and the density of the network being developed. For larger towns and cities this clustering might be done by only including larger employment sites (e.g. where more than 100 people are employed) or only the larger shopping areas.

Identify desire lines

10.4.25 Once trip destination and departure points have been mapped, the next step involves plotting the desire lines between them. The desire lines should be direct and should not follow existing roads or cycle routes – all that is needed at this stage is to identify the corridors along which people want to travel.

10.4.26 The identification of the desire lines should be based on the data, research and local knowledge collected in the information gathering stages. This methodology is scalable – a considerable amount of analysis may be appropriate to identify a complex cycle route network in a city but in smaller towns and villages the desire lines and improvement options may be obvious.

Consider route function and user needs

10.4.27 Prior to converting the desire lines into actual routes, the importance of the route needs to be understood, in terms of the numbers and types of cyclists it will need to cater for (e.g. links to schools will need to cater for younger people's needs which may differ to a primary commuter route). This process informs the designation of route type. The route types are similar to the hierarchies used to identify different levels of service for motor traffic that would be expected on trunk roads, distributor roads and residential streets.

10.4.28 The following classification of cycle routes is recommended. The routes are designated by the importance of the connections they make within the network, not by whether they are a cycle track, cycle lane, shared carriageway or greenway:

- primary routes: The key connections between neighbourhoods/residential areas and a town or city centre; routes between districts and neighbourhoods; links to main public transport interchanges; other cycle routes which are (or which have the potential to be) used by many cyclists
- secondary routes: The links between the primary routes; links to trip attractors such as schools, colleges, employment sites; cycle routes which are an attractor for a more limited range of users; links to local public transport interchanges and stops; other routes which may cater for fewer cycle journeys than the primary routes but are still of strategic importance within the network

- local routes: All other all-purpose roads, greenways and bridleways that are not necessarily part of a designated route (e.g. many residential streets). This basic network of local routes, although lower in the hierarchy, forms an important part of the cycle network

10.4.29 Different thicknesses of line can be used to show the relative importance of the connections as in figure 10.5.

Figure 10.5 – Illustrative demand lines diagram

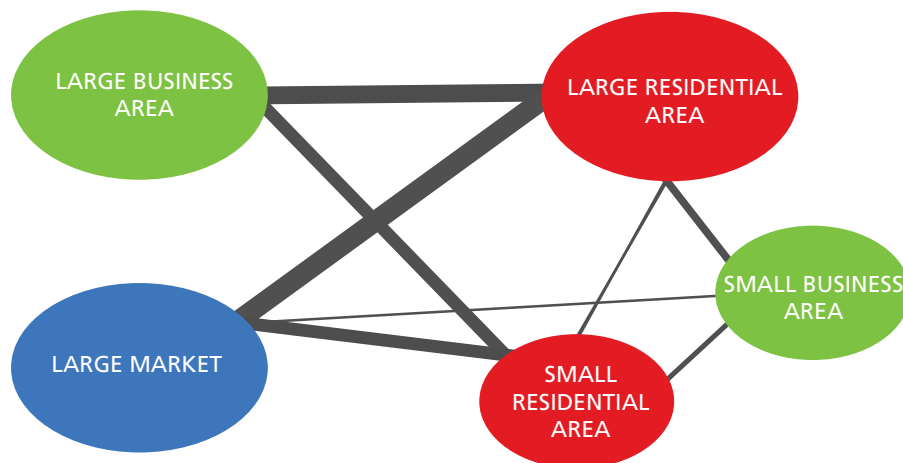

Stage 4: Assessment – Convert desire lines to routes

10.4.30 This stage is critical and involves translating the desire lines into actual routes. Local authorities should make these as direct as possible and make as much use as possible of existing infrastructure and any new infrastructure that is planned, including new roads and streets being provided by new housing and commercial development sites. This can be done initially via desktop study, though the second stage of this will require an on-site audit, described within the next section of this chapter.

10.5 Route auditing and assessment

- 10.5.1 Findings from Stages 1 to 4 (Walking) and Stages 1 to 4 (Cycling) will have provided a network of desire lines or area based treatments for active travel, applicable to either, or both modes.
- 10.5.2 Figure 10.6 shows how to convert these desire lines appropriately as an Existing Route or a Future Route. Further details regarding the design standard scores are described in the section relating to the audit tools in and section 10.6.

Figure 10.6 – Process flowchart for identifying routes to be added to the ATNM

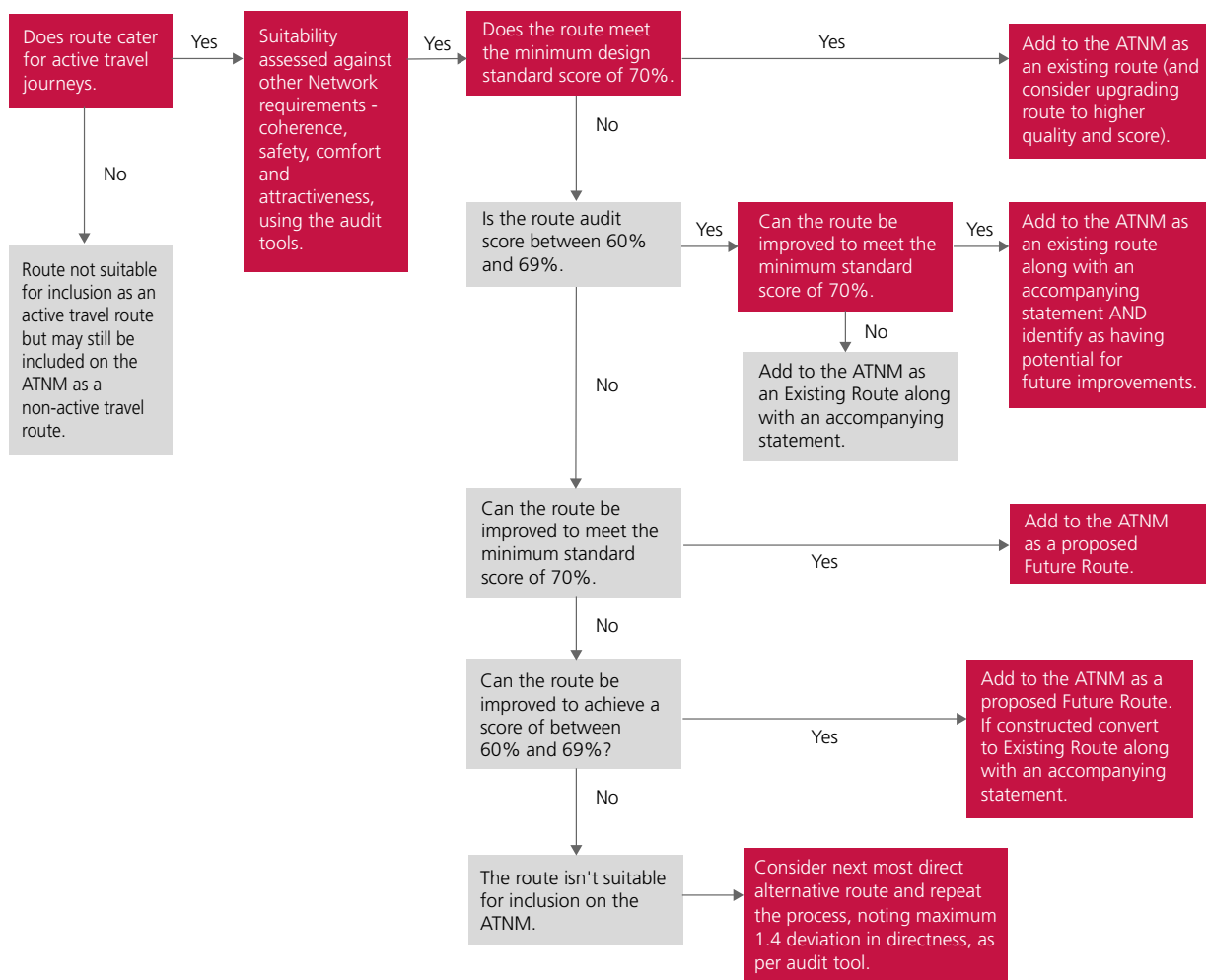

- 10.5.3 Step 1. Check route function and identify most direct route. If there are several optional routes between points, they will all need to be assessed to determine which is the most suitable. Reference should also be made to the basic user needs given in chapter 9.
- 10.5.4 Step 2. Check suitability of route. The most direct route should then be assessed in terms of the other key requirements of coherence, safety, comfort and attractiveness given in table 10.2 and the design guidance and standards set out in chapter 11 and chapter 12.
- 10.5.5 Once appropriate alignment options are agreed, the routes should be audited. Appendix H provides the walking and cycling audit tools and associated directions for use. The tools are intended to be used in conjunction with a site visit, and provide a means of ensuring that all factors which make up the key requirements are considered.
- 10.5.6 Sections 10.6 – 10.8 outline in detail the process for auditing routes and determining their status as Existing Routes, Existing Route with Statement, or Future Route.

- 10.5.7 Step 3. Even if a route has passed the audit process it could still be improved to raise the standards. If the route is not suitable in its current condition, an assessment should be undertaken to identify the works or measures that would enable it to fulfil the network requirements and the design standards. The audits for Future Routes are primarily concerned with identifying the nature of the issue and likely feasibility or scale of works required to meet the active travel design standard.
- 10.5.8 The audit process could then be repeated on the proposed design to see whether the improvements will ensure the route meets the minimum design standard. Feasibility of route options should involve the following considerations:
- there is often more than one solution – options should be considered (and consulted on) to identify the best solution for all road users, including engaging with users or key stakeholders
 - work towards the optimum solution for active travel, in line with the design principles – the aim is to make cycling and walking on active travel routes more inviting than using motor vehicles
 - the existing motor traffic situation must be considered – this should be based on actual surveys and observations (of speed, volume, parking and loading demand, turning movements as applicable). It should not be assumed that traffic speeds and volumes are low in all residential streets. In congested situations or where there is kerbside activity, segregation may be required despite low speeds
 - speeds and volumes of motor traffic on any route are not fixed – can one or both can be reduced?
- 10.5.9 A high proportion of collisions involving pedestrians and cyclists occur at junctions. Active travel networks should ensure that there are no gaps in provision along any part of a route. Junctions should be given particular attention, as they often ‘unlock’ areas of quiet streets and connections to greenways. The following should be considered at junctions during the assessment stage:
- speed reduction through the junction and legibility of use are crucial factors in improving safety for all users;
 - junctions should be designed such that all users are aware of the potential positioning and movements of other users;
 - visibility and eye contact can help different road users to communicate and improves safety
 - pedestrians and cyclists wherever possible should be given equal status and priority with motor traffic through priority over quieter side roads and other considerations, such as increased green time at traffic signals (particularly on uphill routes).
 - conventional roundabouts often pose a high risk to active travel users, for cyclists due to the speed differential and difficulty in road positioning, and pedestrians as

desire-line crossing points are often on entry/exit arms, which, depending on the geometry, may have high traffic speeds

- multi-disciplinary design input – the best designs, particularly for complex transport problems are often identified through interactive sessions involving user groups, stakeholders and designers

10.5.10 Step 4 (if applicable). Reconsider options. If the preferred route cannot be brought up to an acceptable standard, or if the impacts on other road users are considered too onerous, what other route options are available?

10.6 Audit and mapping process for existing routes

10.6.1 The act requires that Existing Routes which already meet or exceed criteria must be mapped. These show the current network of routes suitable for making active travel journeys, and highlight gaps to help develop the network of future routes.

10.6.2 If a route is to be included on the ATNM as an Existing Route, it must be audited and scored using the Audit Tool, with the audit score and associated description documented for future reference. An initial desktop study of routes identified at the network planning stage can help to establish which routes are likely to meet existing standards and 'pass' the audit.

10.6.3 The desirable audit score is 80% or above, with a minimum score of 70% being required to pass, to confirm the route is suitable for active travel (and justified for inclusion on the map as an Existing Route).

Critical fail

10.6.4 A route that has any element that is marked as 'Critical' is not deemed suitable for active travel and cannot be included as an Existing Route. However if the route can be improved to address the 'Critical' element then it can be included as a Future Route on the ATNM.

10.6.5 Critical elements for walking include if the route is missing drop kerbs, thus rendering the route inaccessible for some users. For cycling, critical elements include if more than 50% of the route includes cycle provision with widths which are more than 25% below desirable or if the route is on-carriageway and has higher than acceptable traffic flows and speeds.

Audit review

10.6.6 When reviewing the map every three years, routes that have already passed are not necessarily required to be re-audited, though the previous audits should be reviewed against any changes to the design guidance or the route itself, to ensure the classification is still applicable.

10.6.7 Routes that have failed with an accompanying statement (see below) should be re-audited to ensure the statement is still applicable. Where this is the case, the statement will need to be re-accepted by Welsh Government.

10.7 Existing Routes - Pass with Statement

- 10.7.1 Where a route falls short of acceptable design standards, or where a route loses percentage points during the audit, because of a factor that cannot reasonably be modified, it may be eligible to be included as an Existing Route with an accompanying statement - a 'Pass with Statement' route should have a score between 60% and 69%. This statement must be included on the mapping system when the ATNM is submitted for approval by the Welsh Ministers.
- 10.7.2 Statements must contain sufficient detail about the shortfall of the route for an assessment to be made of its impact on the route's usability. For example, where a path is below the width recommended within this guidance, the statement must indicate the actual width and the length of the route affected by this. Where a shortfall is likely to be permanent in nature, for example a route passing through a narrow bridge opening, an explanation should be given why an alternative route is not being used. Mitigating factors may also be included in the statement, for example where an unlit path is only likely to be used during daylight hours, or where a narrow path will have only light usage. The information used in the statement will normally be derived from the audit process. Some examples are included below:
- this important primary route to the high school from the town centre is constrained by the narrow footways (1.0m wide for approx. 90m) and the speed of traffic in this area
 - this route is a key link between the retail park, residential areas, schools and the industrial estate area. The route can have relatively high traffic flows and lacks a suitable connection to the retail park at the southern end
 - this route is a key link between the rail and bus stations as well as a central connection between the town centre and the riverside path. There is no dedicated cycle crossing at New Road, limited signage and a lack of priority crossings for cyclists

10.8 Future Routes

- 10.8.1 Routes that the act previously referred to as to being shown on the Integrated Network Map shall now be referred to as the Future Routes, on the ATNM. Future Routes to improve conditions for active travel can include both existing route upgrades and new-build alignments as well as modifications to the existing highway network and Public Rights of Way.
- 10.8.2 Future Routes on the ATNM are intended to show plans for the development of the network over the next fifteen years. The routes shown on the map must be based on an analysis of where people are likely (or could be expected) to make active travel journeys.
- 10.8.3 The future routes identified on the ATNM do not need to be highly detailed, at least in the initial stages, some routes will be shown simply as desire lines. To be included on the ATNM, the siting of a desire line must have followed the processes set out in this chapter.

- 10.8.4 Desktop studies may identify Future Route alignments that will not yet be able to be reasonably audited (for example, a proposed new river crossing), though where possible, it is a useful exercise to audit Future Route alignments to identify where improvements need to be made.
- 10.8.5 Where funding is being sought from Welsh Government for a new route or improvements, a current and potential audit score must be provided to accompany a funding application.
- 10.8.6 At this stage, the audits for Future Routes are primarily concerned with identifying the nature of the issue and likely feasibility or scale of works required to meet the active travel standards. Detailed design solutions do not need to be proposed.
- 10.8.7 Additional auditing tools could be used where appropriate to provide context and to take account of stakeholder views during scheme specific designs. There are several other methods for auditing infrastructure, ranging from detailed street audits, to surveys that only consider specific aspects of the infrastructure (such as footway condition surveys).

10.9 Active travel network map

- 10.9.1 As outlined within chapter 1, the purpose of mapping Existing Routes and Related Facilities is to communicate where walking and/or cycling routes within a proposed network are already available and suitable for active travel. This also helps to illustrate the context and justification of Future Route alignments and/or Related Facilities.

Presentation of routes

- 10.9.2 Routes agreed as part of the network development process to be included on the ATNM include the alignments of both Existing and Future Routes, as outlined within the steps taken above. For Future Routes where exact alignments are yet to be decided, these can be illustrated as point to point desire lines. The map markings should illustrate the type of route in place or proposed (for example, whether a route is on a footpath away from a highway, or adjacent to a highway on a footway), and this will be achieved by selecting the appropriate attribute when inputting the route on the Welsh Government provided mapping system.
- 10.9.3 Related Facilities, both existing and planned future facilities (where known) should also be shown on the ATNM. Depending on the local context, this may include:
- cycle parking/storage/maintenance facilities
 - e-cycle or electric mobility aid charging facilities
 - public cycle–hire docking or hire facilities
 - public mobility aid docking or hire facilities (e.g. Shopmobility)
 - public toilets and/or washing facilities

- 10.9.4 Potential barriers or considerations walkers and cyclists may need to be aware of, should be shown on the ATNM and could include:
- access barriers which prevent infrastructure being fully accessible (including steps without adjacent ramped provision)
 - level crossings
 - one-way streets
 - places that are not accessible at all times (e.g. gated at night)
 - routes or sections that have no streetlights
 - routes or sections where widths are less than the minimum specified in the design guidance
 - roads where walking or cycling is not permitted
 - roads without pavements
 - steps and/or steep gradients (e.g. above 1 in 12)
- 10.9.5 Other walking and cycling routes, including Public Rights of Way, that do not meet the design standard (and cannot be modified) or whose purpose is primarily for leisure, may be shown on the ATNM for completeness but cannot be classed as active travel routes and should be differentiated in terms of how they are represented. On [DataMapWales](#) they are shown as 'Other' routes and can be useful for identifying additional walking and cycling provision such as the Wales Coast Path or sections of the National Cycle Network.
- 10.9.6 Each route shown on the Map must have a Route ID number and it is recommended that a simple identification system is used across the authority area for consistency. An example could include: Local Authority – Settlement – User Type – Number E.g.
- Wrex-Llay-W (or C or SUP)-001
 - NPT-Neath-SUP-004
- 10.9.7 Routes should connect key destinations or connect a key destination to a junction with another route on the active travel network and a title can be included alongside the Route ID. If a longer route is required it may need to be split along infrastructure or delivery options and a sufficient section reference should be included at the end. E.g.
- Wrex-Llay-W (or C or SUP)-001-A
 - Wrex-Llay-W (or C or SUP)-001-B
 - Wrex-Llay-W (or C or SUP)-001-C

10.9.8 Short sections of route should be avoided where possible. For example using separate route numbers for different sections of infrastructure between key destinations is not recommended. It is preferable to use the same route ID to be used for the entire route as this demonstrates coherence and continuity, two key features of route planning.

10.10 Routes on land not owned by a local authority

- 10.10.1 The agreement of landowners to showing active travel routes on the ATNM is not required where the route is an existing right of way, and of the appropriate classification for the use specified in the map (i.e. accessible to walkers if shown as a footpath). However, efforts should be made to bring the ATNM to the landowner's attention.
- 10.10.2 If the route is a permissive route, then the landowner's agreement must be sought. In many cases a note to confirm agreement will be sufficient. This should be undertaken during the compilation of the map, before the public consultation on the Map begins. If there are time restrictions on when a permissive route can be used this should be noted on the Map.
- 10.10.3 Consent is not required to show possible future routes on the ATNMs, but reasonable effort should be made to notify and consult with landowners wherever possible. Depicting a route on a map does not negate the need to follow due process for route enhancements and creation (such as traffic regulation orders or path creation orders) and landowners who are unwilling to have these plans enacted on their land will have opportunities to object at the appropriate stages.

10.11 Validation of active travel network maps

- 10.11.1 Once the draft ATNMs have been produced, before submission to Welsh Ministers, they must be validated through a statutory consultation process that must last at least 12 weeks and should be as extensive as possible to help ensure all those who may be affected by the proposals have a chance to input. General advice on consultation techniques and parameters is included in chapter 8.
- 10.11.2 Prior to this statutory consultation period a local authority may want to carry out interim engagement with internal and external stakeholders to shape the proposals.
- 10.11.3 It is important to be clear in any statutory public consultation that the ATNMs show longer term aims and outline ideas. Engagement on the maps does not replace the need for formal consultation and negotiation on individual schemes as and when specific proposals for delivery/implementation are taken forward, as highlighted in chapter 8.

10.12 Submitting the active travel network map

- 10.12.1 Following the statutory consultation, any required amendments should be made to the ATNMs (for both walking and cycling improvements) prior to submission to the Welsh Ministers for approval. Chapter 4 provides details of the factors Welsh Ministers will be considering for approval of the map(s).
- 10.12.2 Welsh Government's active travel mapping system on [DataMapWales](#) provides the functionality for maps to be submitted automatically. Detailed instructions will be provided to Authorities at the time when ATNMs are due for submission.

10.13 Publishing the map

- 10.13.1 The act requires that local authorities publish the Map, and any statement and explanation of routes that do not meet the design standard. Key requirements for publishing the map are provided within chapter 4. Local authorities are encouraged to bring the Map to the attention of the local population in an appropriate way for their area.
- 10.13.2 [DataMapWales](#) will include functionality for public viewing of the ATNM. Consideration should be given to whether the technical nature of this resource is the most appropriate method for publishing active travel route information for all public audiences. Holding the map digitally allows local authorities to share information which is up to date and to provide features such as layered maps for different kinds of uses.
- 10.13.3 However, even in areas with high rates of internet use, there are still many people who cannot or choose not to use the internet. Local authorities are encouraged to publish maps of local walking and cycling routes in their communities to help encourage more people to use these modes, both online and as hard copies and so they should therefore be available on request as a minimum. An example of a published map is provided in Appendix C.
- 10.13.4 The Map may also be used to inform other projects such as personalised travel planning and the development of apps and websites. The Map and underpinning data, where possible, should be made freely available to bodies undertaking this work to enable them to improve their provision of information. Consideration should be given to the technical complexity of the ATNM in its original format on Welsh Government's mapping system, and that local authorities may wish to simplify when making the maps available for specific public facing purposes.
- 10.13.5 Local authorities could also consider specific formats for specific purposes, for example, to aid a large employer's work-based travel planning, or to promote a new section of route. Local authorities might want to use the information in the ATNM to create maps for walkers only, cyclists only, or mixed categories of the two.
- 10.13.6 Local authorities may wish to explore advertising opportunities, such as sponsorship, when publishing their maps. This may help further promote active travel and could help offset some of the publication costs.

10.14 Partial review of the map

- 10.14.1 Chapter 4 describes the option for local authorities to review their map within the 3 year review period, this section outlines the process required for this to take place.
- 10.14.2 Local authorities should ensure that all the organisations involved in the last full consultation process and all the individuals who have requested that they be consulted about the Map are informed of the intention to conduct a partial review, and that they are provided with an opportunity to comment. Local authorities should also ensure that any ongoing engagement mechanisms they have in place are made aware of the intention to conduct a partial review, so that all stakeholders have the opportunity to be involved.
- 10.14.3 At least one public consultation event must be held in each of the settlements affected by the revision. Those events should be fully accessible, as advised in chapter 8.
- 10.14.4 The consultation process should run for a minimum of 12 weeks.
- 10.14.5 Submitting a partial review will not affect the three-year timetable for submitting the authority's full review of the map.

10.15 Prioritising the active travel routes

- 10.15.1 Local authorities shall have a clear plan for the delivery of their Active Travel upgrades over a fifteen year period. The parts of the network that potentially offer the greatest impact on increasing rates of active travel should be prioritised, but other local priorities may also be considered such as targeting areas of deprivation or poor public health and these priorities should be established by setting network aims. Local authorities should also be mindful of their duty to contribute to the achievement of the goals of the Well-being of Future Generations Act.
- 10.15.2 A data led approach should be used for prioritisation analysis and decision making about which routes are most important to achieving the network aims or offer the best value for money. The validation stage may also prove a useful source for assistance in deciding priorities.
- 10.15.3 Where several small schemes have been identified within the same area, or on the same route, it may be appropriate to merge the schemes into a package of works, to help ensure that individual measures are implemented together and achieve complementary benefits and synergies.
- 10.15.4 The advantage of using a prioritisation framework is that it brings some consistency to the assessment of schemes across a local authority area. A methodical scoring system also ensures that consideration is given to important aspects such as the impact of schemes for increasing active travel so that deliverability does not take precedence as the main factor determining prioritisation. Local authorities should consider how they make the public aware of the prioritisation to raise awareness on why certain routes are being developed before others.

- 10.15.5 Some local authorities may have existing prioritisation tools in place for aiding the decision making process regarding infrastructure projects, including specific active travel tools. A scoring matrix to assist prioritisation of schemes identified in the ATNM, together with the associated scoring criteria, is included at Appendix K.
- 10.15.6 Factors such as the level of available funding and the opportunities for 'quick wins' that demonstrate progress are also important in considering which schemes to take forward. Whilst larger and more complex routes may have a long lead in due to the complexity of planning and design required, where they are prioritised these proposals should be designed and developed in parallel with the delivery of less complex routes.
- 10.15.7 One of the advantages of the prioritised ATNM is the ability to deliver the network through a broader range of funding sources and not just through budgets specific to active travel. This includes opportunities to gain new routes and improvements through planning gain, developer contributions or associated conditions, but this will introduce dependencies on the timeline of the development to deliver network elements. It may also allow ways for more ambitious long-term schemes to be planned and delivered as part of major highway or redevelopment schemes.
- 10.15.8 There are a number of modelling tools that use transport and demographic data to help to indicate potential impact and, with data to estimate the typical costs of construction, it is possible to arrive at a Benefit:Cost Ratio. For future ATNMs, this data could be used to inform the network planning stages outlined above. This is a rapidly developing area as more data becomes available from mobile phones and fitness apps, and with better monitoring of actual scheme costs and usage, these tools will become more refined in the future. This information, along with the additional factors that are set out in table 10.3 below, can also be used to inform the decision making process.

Table 10.3 – Additional factors that could be considered during scheme prioritisation

Criterion	Method	Source of data
Access to jobs	Higher priority for routes that serve areas of high employment density	Census – Workplace population
Air quality	Higher priority for routes that offer mode choice in areas of poor air quality	AQMA or local AQ monitoring stations
Congestion	Higher priority for routes that offer mode choice in areas of high congestion	Traffic flow data or local transport model
Deliverability	Higher priority for routes that are most deliverable, e.g. availability of funding or complementary schemes	Local authority knowledge
Deprivation	Higher priority for routes that serve areas of multiple or specific indices of deprivation (NB: be mindful that multiple indices potentially double-count other criteria in this table)	Indices of multiple deprivation or specific sub-domains
Growth	Higher priority for routes that connect to sites earmarked for development	Local plan, Strategic Housing Land Availability Assessment (SHLAA) etc.
Local safety	Higher priority for routes in areas with a high rate of cycle collisions per cyclist or per km – cycled Cycle collision needs to also consider pedestrian collision data	Stats 19 collision data; DfT or local traffic counts
Pinchpoint/severance	Higher priority for routes that overcome significant barriers in the network, i.e. waterways, railways or major highways	Local authority knowledge
Propensity to cycle	Higher priority for routes in areas where propensity for short trips is highest (number of short, cycleable trips as a ratio of all trips)	www.pct.bike , Census – JTW or local transport model
Public health	Higher priority for routes that serve areas with high rates of inactivity-related health complications, e.g. obesity, diabetes	Locally available public health data, e.g. obesity rates
Transport inequality	Higher priority for routes that serve communities with low car ownership and/or low accessibility to public transport	Census – household car ownership; public transport accessibility



Chapter 11: Designing for active travel routes and links

This chapter provides guidance on the design of active travel routes for walking and cycling. Section 2(6) of the Active Travel Act requires local authorities to have regard to this guidance when determining whether a route is suitable to be designated as an active travel route.

Key areas of consideration include:

- status of the design elements
- design considerations, such as separating cycle and pedestrian surfaces, allowing sharing to take place only where there is sufficient width
- suitability of provision depending on traffic speeds and flows (Table 11.1)

11.1 Introduction

- 11.1.1 This chapter provides advice on design of active travel routes and links, which meet the needs of pedestrians and cyclists, in urban and rural situations. A link can be the section of route between junctions and crossings, or a dedicated link onto an active travel route.
- 11.1.2 It builds on guidance on the User Needs (chapter 9:) and Network Planning for walking and cycling (chapter 10). It should be read in conjunction with chapter 14 on Related Facilities, which covers direction signing, cycle parking and features of value to pedestrians, such as benches; as well as chapter 15 on construction, maintenance and management, which includes details on drainage, fencing, tactile paving, lighting and access controls.
- 11.1.3 Appendix G provides more detailed design guidance on specific measures combining advice on key design features with other considerations, alongside a drawing for each of a series of Design Elements. Where the text refers to a Design Element in Appendix G it is noted with a reference, e.g. DE205. The Design Elements are grouped into related series.

11.1.4 Each Design Element (DE) is given a status as described below, defined as:



Standard details

Details that are well understood and should be applied as shown, as a minimum, unless there are particular reasons for local variation.



Suggested details

Details that have not been widely applied in Wales but should be considered appropriate for use in the circumstances as advised.



Possible details

Details that are uncommon in Wales but have been used successfully in other places and may be considered for use in schemes to gain further experience.

11.1.5 Elements denoted as Standard Details shall be regarded as “standards” for the purposes of chapter 3(6)(a) of the Active Travel Act. When modifying existing local highways and other Public Rights of Way it may not always be possible to meet the ideal dimensions set out in the Guidance, and the constraints that lead to a departure from such standards should be noted. As stated in chapter 7, authorities should provide justification to Welsh Government where a scheme included in an ATNM cannot meet the desired standard due to localised constraints. This can be undertaken in the form of a simple note to accompany the ATNM. Local authorities should contact the Active Travel team at Welsh Government if they need further advice on an individual scheme.

11.1.6 Where designs categorised as Suggested Details or Possible Details are used they will require monitoring and evaluation by the organisations that implement them to ensure they perform as expected. Welsh Government would like to be kept informed about any lessons learnt as new designs evolve so that they can be cited as good practice in future. There is no requirement for formal approval from Welsh Government to use Suggested or Possible details – the decision to introduce these layouts is a matter for the individual highway authority. Welsh Government may however be able to provide advice or cite examples of similar schemes elsewhere to assist designers.

11.1.7 The terms ‘absolute minimum’ and ‘desirable minimum’ are used throughout this technical guidance. Desirable minimum is the best practice provision which should be provided whenever possible. If the lesser standard absolute minimum is used then the designer shall keep an audit trail of decisions made to justify why the best practice level of provision can not be provided. Any proposed infrastructure below absolute minimum should not be developed or constructed.

11.2 General design considerations

11.2.1 Important design factors for routes and link sections include:

- design context and relative importance of movement and place functions
- physical dimensions of the highway, including available widths and gradients
- connections with adjacent routes
- be inclusive to meet the needs of all users (see chapter 9)

- active travel routes need to form a coherent network (see chapter 10)
- expected future growth of pedestrian and cycle traffic
- the type of route (Primary, Secondary or Local – chapter 10)
- motor traffic speeds, volumes and proportion of HGVs
- kerbside activity, such as parking, loading and bus stops
- construction, maintenance and enforcement requirements; and
- scheme cost and available budget

11.2.2 Active travel routes may be delivered by:

- providing separated infrastructure along busy roads
- following low speed and traffic volume roads or traffic-free paths (whilst still being as direct as possible)
- using measures to reduce motor traffic speeds and volumes and the maximum size of vehicles where routes are also open to motor traffic
- reallocating space from traffic lanes or car parking to use for pedestrian and cycle traffic

11.3 Link design considerations

11.3.1 A link is defined as a section of route between junctions or a stand alone section of route connecting to another active travel route. Link design should be considered alongside junction design, which is covered in chapter 12, and the five design principles should be followed.

Direct

11.3.2 Pedestrians and cyclists prefer to follow natural desire lines which avoid deviations. Where pedestrian routes are indirect many users will take the shortest available desire line, away from the formal footway or footpath. Routes for cyclists should be as least as direct as those for motor traffic.

11.3.3 Directness in terms of time is important. Having to slow down or stop imposes a substantial time penalty and wasted effort. Cycle tracks should be of adequate width for the expected flows to enable overtaking amongst cyclists.

Safe

11.3.4 To minimise risk of collisions and injury to pedestrians and cyclists attention should be given to:

- providing sufficient width so that pedestrians are not required to step into the paths of motor vehicles or cyclists due to crowding
- providing adequate geometry, visibility and space for cyclists, allowing for user errors and evasive manoeuvres

- separating cycle and pedestrian surfaces, allowing sharing to take place only where there is sufficient width
- reducing the volumes and/or speeds of motor traffic to a level which allows people of all ages and abilities to cycle in comfort and safety – or, where this cannot be achieved physically separating cyclists from motorised traffic
- ensuring that the design of any infrastructure for cyclists reflects how cyclists are trained through National Standards Cycle Training

Comfortable

11.3.5 In addition to the principles above, comfortable walking and cycling routes will help to attract new users and this can be achieved by:

- minimising gradients and keeping slopes as short as possible
- providing good lighting, smooth and well-maintained surfaces (including regular clearance of vegetation and debris)
- avoiding placing obstructions in a route and removing existing ones
- providing adequate width for the volume of pedestrian and cycle traffic
- minimising effort by avoiding cyclists having to slow down or stop on links
- minimising nuisance from motor traffic, through reduced speeds and greater separation
- minimising conflict between pedestrians and cyclists

Attractive

11.3.6 Pedestrians and cyclists are much more exposed to their environment than people in motor vehicles, so are more sensitive to the quality of experience when using a route. Routes should:

- look attractive and be interesting
- integrate with and complement their surroundings
- contribute to good urban design
- feel secure, be well overlooked and lit
- be well maintained

11.4 Cycling routes and links

11.4.1 Table 11.1 shows what conditions most people will find acceptable for cycling (in green) while conditions that will exclude some people are shown in amber and red. The existing amount of motor traffic and speed limits offer a starting point to consider whether to separate cyclists from motor traffic, or to reduce traffic speed and volume to a level that is acceptable to most people. Streets that already have low motor traffic speeds and volumes help to make up the basic network. The basic network, also referred to

as local network, refers to all local quiet streets where low speeds and volumes of traffic make them suitable for walking and cycling, without need for designated cycling infrastructure.

Table 11.1 – Cycle provision on links

Speed Limit ¹	Motor Traffic Flow (AADT) ²	Protected Space for Cycling			Cycle lane (mandatory/ advisory)	Mixed Traffic
		Fully Kerbed Cycle Track	Stepped Cycle Track	Light Separation		
20mph ³	0	Green	Green	Green	Green	Green
	2000	Green	Green	Green	Green	Green
	4000	Green	Green	Green	Yellow	Yellow
	6000+	Green	Green	Green	Yellow	Yellow
30mph	0	Green	Green	Green	Yellow	Yellow
	2000	Green	Green	Green	Yellow	Yellow
	4000	Green	Green	Green	Yellow	Yellow
	6000+	Green	Green	Green	Yellow	Yellow
40mph	Any	Green	Yellow	Yellow	Pink	Pink
50+mph	Any	Green	Pink	Pink	Pink	Pink

- Provision suitable for most people.
- Provision not suitable for all people and will exclude some potential users and/ or have safety concerns.
- Provision suitable for few people and will exclude most potential users and/ or have safety concerns.

Notes:

1. If the 85th percentile speed is more than 10% above the speed limit the next highest speed limit should be applied.
2. The recommended provision assumes that the peak hour motor traffic flow is no more than 10% of the 24 hour flow.
3. In rural areas achieving speeds of 20mph may be difficult, and so shared routes with speeds of up to 30mph will be generally acceptable with motor vehicle flows of up to 1,000 AADT per day.

11.4.2 In practice, a cycle route from one place to another will often involve sections of different types of provision: shared roads, cycle lanes, cycle tracks alongside the carriageway and cycle tracks away from the road. A safe and convenient transition between different forms of provision is critical to ensure route coherence.

11.4.3 Separation from motor traffic may be done by:

- light separation – intermittent physical separation from motor vehicles (e.g. use of refuges, planters, bollards, or other features)

- continuous physical separation that can be crossed by cyclists (e.g. stepped track)
- continuous physical separation that can only be crossed at designated locations (e.g. full height kerb, verge)

Coloured surfaces

- 11.4.4 Coloured surfaces are not prescribed by TSRGD and have no legal meaning. There is no obligation to use them and they should be used sparingly to minimise maintenance costs.
- 11.4.5 Locations where properly maintained coloured surfacing may be appropriate for safety reasons are:
- advanced stop line reservoirs and their feeder lanes (DE614)
 - cycle lanes across the mouth of junctions (DE306)
 - routes through complex junctions (DE616-620)
 - cycle lanes alongside on-street car parking (in addition to the buffer strip – DE305)
 - any other areas of potential conflict
- 11.4.6 Colour choice is a matter for the local highway authority, but a single colour should be used within a highway authority for consistency and to simplify maintenance. Green, red or blue surfaces are most commonly used.

Tactile paving

- 11.4.7 Tactile paving is provided on both links and at junctions and crossings to assist visually impaired people in moving around an area. The use of tactile paving should be considered at the design stage to ensure it is fully integrated.
- 11.4.8 Common types of tactile paving and their uses are described in chapter 15, as well as being shown in context on the design element diagrams.

11.5 Co-design

- 11.5.1 Stakeholder participation through consultation and engagement in planning and design is fundamental to the process of developing an active travel strategy and network plan (see chapter 5 and chapter 8). In many cases, a deeper level of engagement, which is guided by the local community, can improve scheme design and acceptability. This is often referred to as 'co-production' or 'co-design'.
- 11.5.2 In a community-led initiative resident groups contribute detailed knowledge of local issues (often assisted by engagement specialists) to work with the highway authority and other partners to create local infrastructure improvements for active travel.
- 11.5.3 Co-design can be applied to any street to help residents, businesses and other stakeholders directly address the local issues and opportunities to improve their street or neighbourhood. The aim is to create streets that can become spaces for a wider variety of community activity, using pedestrian crossings, benches, planting and other features to restore the balance between traffic and people. This can help make streets into safer and more attractive places to live, work or visit.

11.5.4 Chapter 8 recommends that co-design should mainly be applied to the development of significant schemes. For example, for bigger developments or across an existing neighbourhood, engagement is best carried out at several stages throughout the project. For minor works, e.g. provision of a drop kerb crossing, statutory processes will be sufficient, but stakeholders may be approached for their local knowledge.

Figure 11.1 – Co-design process being undertaken as part of a scheme



11.5.5 Home Zones are residential streets in which the design speed is set very low, at less than 20mph and maximum motor traffic flows of 100 vehicles per hour are the norm. Often, the whole highway is shared between all road users, although it can include pedestrian-only spaces for vulnerable users. Co-design of the space is key to making the scheme work and to change the behavior of residents and other street users. See 11.8 for other area wide schemes where engagement and co-design are also key.

11.5.6 Home Zones are legally designated under the Transport Act 2000. Designers should follow the principles set out in the Manual for Streets and Manual for Streets 2.

11.6 Reducing the speed and volume of motor vehicles DE201, DE202, DE203 and DE204

11.6.1 Where traffic volumes and speeds exceed the values for a mixed traffic link (table 11.1) consideration should be given to reducing traffic flows and speeds so that cycling can be accommodated on the carriageway. Table 11.2 provides a list of techniques that can be used to create suitable mixed traffic routes and links and assist in creating a basic network, mainly for cyclists but which also enhance the environment for pedestrians.

11.6.2 Pedestrian and cycle traffic will usually benefit in terms of safety, comfort and attractiveness from a reduction in the speed and volume of motor traffic along links and at junctions. The range of measures used to achieve this to help create the basic network described previously in section 10.4.5.

Table 11.2 - Creating the basic cycle network by managing traffic speed and volume

Measure	Description
On-carriageway	Advisory cycle lanes and removal of centre lines as an aid to speed reduction. Signed routes on quieter roads and streets. Modifications to junctions such as advanced stop lines, or altered priority for the cycle route
Filtered permeability	This technique involves the 'filtering out' of motor vehicles (sometimes of only private traffic, with bus access retained) from parts of a network. Cycling and walking permeability, i.e. providing a choice of routes through a network, is retained. If access for motor vehicles in one direction only is removed, cycling should be permitted in both directions (contraflow cycling)
20mph limits and zones	Vehicle speeds are reduced, ideally with physical measures, to create a lower speed environment
Physical traffic calming	A range of options exist for reducing traffic speeds through physical measures, such as road humps and carriageway narrowing. Any traffic calming devices should be designed to be safe and comfortable for cyclists
Changes in road geometry and layout	Manual for Streets provides guidance on how road geometry and layout can be used to reduce motor traffic speeds such as reducing carriageway width, reducing forward visibility and using sharp changes in direction. Reallocating carriageway width to widen footways and/or to enable dedicated space for cycling will tend to reduce speeds and provide additional safety and comfort for active travel. Quiet Streets and Cycle Streets involve the introduction of features to the carriageway layout which show that the route is intended to be used as an important cycle route
Low traffic neighborhoods (LTNs)	LTNs are an area wide approach to reduce the volume of motor traffic and can give active travel modes an advantage through exemptions to the restrictions applied to motor traffic, usually using a mixture of the options above
Home zones and DIY streets	Home zones comprise residential streets in which the whole of the road space is shared between all road users, although it will often include a pedestrian-only space for vulnerable users. Design speed is set very low, at less than 20mph. Home zones enhance streets so that they are not just traffic routes but spaces for community activity. DIY streets use a similar approach but in a low-cost way, with the design and implementation of the scheme being led by the local community
Quiet lanes	Quiet lanes are the rural equivalent of home zones. These are aimed at making country lanes more attractive for walking, cycling and horse riding

- 11.6.3 Cyclists should be exempted from restrictions applied to motor traffic on links or at junctions where safe to do so, or through the creation of short connections which are only available to cyclists and pedestrians, to give them time and distance advantages. DE204 shows how a cycle-only access can be provided which includes a central lane to assist right-turning cyclists, while an unsegregated contraflow is illustrated in figure 11.2.

Figure 11.2 – Contraflow cycle lane, Penarth



11.7 Speed reduction - traffic calming DE201, DE202 and DE203

- 11.7.1 Traffic calming measures reduce motor vehicle speeds thereby improving safety for pedestrians, cyclists and residents living along traffic calmed routes. Designs must take particular account of feedback from the emergency services and bus operators.

Figure 11.3 – Example of a raised table with tactile crossing point in Cardigan, Ceredigion



- 11.7.2 Poorly designed vertical features, such as speed humps and tables, can be uncomfortable for cyclists and horizontal deflections, such as build-outs or chicanes and pinch points can feel hazardous if vehicles attempt to overtake.
- 11.7.3 Sinusoidal humps are more comfortable for cyclists – see DE202 for details and cycle bypasses should ideally be provided at pinch points – see DE203.
- 11.7.4 Changes in basic road geometry and appearance, such as using narrower carriageways, removing centre line markings, reducing forward visibility, sharp changes in direction or changes in priority at junctions can all contribute to speed reduction.

11.8 Filtered permeability and low traffic neighbourhoods

- 11.8.1 Filtered permeability uses traffic management techniques to reduce the volume of motor traffic and can give active travel modes an advantage through exemptions to the restrictions applied to motor traffic. This simple technique can significantly reduce through-traffic to make areas safer and more pleasant for walking and cycling without major infrastructure investments.
- 11.8.2 Area wide engagement is key for the success of these measures and extensive filtering schemes such as in Waltham Forest have seen significant changes in travel behaviour and improvements in air quality¹.
- 11.8.3 Filtered permeability uses Traffic Regulation Orders (TROs), typically:
- road closures for motor traffic
 - point closures at one end of a street
 - banned turns
 - one-way streets
- 11.8.4 There should be a presumption to exempt cyclists from any such TROs unless there are overriding safety reasons for not doing so, which could include an unacceptable impact on pedestrians. Residents and businesses are usually concerned about the impacts of restricted access or displaced traffic and should be consulted at all stages of the development. Experimental or temporary TROs and removable features can be used so that schemes can be trialled and monitored prior to construction, thereby helping to address local concerns while allowing sufficient time for people to adjust to the new infrastructure, and for schemes to be modified.
- 11.8.5 Figure 11.4 shows how access to a side street has been provided for cycles only, similar to that shown on DE204 and this type of facility is often known as a modal filter.

1

<https://www.enjoywalthamforest.co.uk/wp-content/uploads/2015/01/Waltham-Forest-Mini-Holland-Design-Guide.pdf>

Figure 11.4 – Modal filter allowing pedestrian and cyclist access through an area restricted to motor vehicles



- 11.8.6 It is important when designing modal filters that access for people walking and cycling is maintained and improved. Gaps for clear spacing between features of at least 1500mm should be provided to enable all types of cycle to use them. Pedestrian routes and footways should also provide clear, easy to navigate routes and where possible the opportunity should be taken to provide an at grade crossing point. The transition from any adjoining cycle networks should be seamless with no sharp corners and free of any kerb upstands.
- 11.8.7 Further information on low traffic neighbourhoods is available from [Living Streets: A Guide to Low Traffic Neighbourhoods](#).

11.9 Quiet streets DE205

- 11.9.1 Urban cycling routes on streets with low traffic speed and volume are generally suitable for new and less confident cyclists. Routes should maintain continuity for cycling and tackle barriers such as junctions and crossings at main roads that provide access to otherwise quiet streets.
- 11.9.2 Cycle symbols to Diagram 1057 can be used to sign cycle routes and indicate the correct positioning for cycling within the carriageway.

Figure 11.5 – Diagram 1057 painted onto carriageway



11.10 Cycle streets DE206

11.10.1 A cycle street is a quiet street which also serves as a primary cycle route. To succeed it should carry low volumes of motor traffic (under 2,500 AADT), and high volumes of cycling that significantly exceed motor traffic levels, to provide cyclists with a level of comfort comparable to that provided by a traffic free route.

11.10.2 The objectives of a cycle street are to:

- Present a legible design recognisable to all types of user as a main cycle route
- influence behaviour so that cyclists assume priority with drivers of motor vehicles behaving as 'guests', travelling at low speeds
- maintain priority for cyclists, so that drivers do not overtake them until they leave the cycle street
- be attractive to experienced cyclists and less confident cyclists

11.10.3 Cycle streets are not recognised within TSRGD but the Department for Transport previously indicated that cycle streets could be subject to:

- a ban on motor vehicles overtaking cyclists
- an advisory speed limit of 15mph

11.10.4 Signs and orders to support these restrictions would therefore require special authorisation from Welsh Ministers and authorities should seek advice from Welsh Government.

Figure 11.6 – Cycle street, Cardiff



11.11 Pedestrian prioritised and informal streets

11.11.1 These streets reduce the dominance of motor vehicles with design features that enhance the status of pedestrians and cyclists. The designs usually involve significant improvements to the public realm such as high-quality surface materials, street trees, planting and seating.

Figure 11.7 – Informal street with heavy pedestrian footfall (Note the cycle parking and on-street seating)



- 11.11.2 A review undertaken in 2018 by Institute of Highway Engineers has identified two types of approach; Pedestrian Prioritised Streets with very low volumes of motor traffic where the whole street surface is primarily for pedestrians; and Informal Streets where volumes are higher and designated space for walking and cycling is required, as well as defined pedestrian crossing points. The specific issues for blind and partially sighted people are described in more detail in the National Federation of the Blind (2013) Access for Blind People in Towns.
- 11.11.3 A level surface is a form of shared space, where the street is not physically divided by kerbs or a level difference indicating areas for particular modes. These streets need careful design if they are to work for all users.
- 11.11.4 Blind and partially sighted people find shared space difficult to use and may avoid such areas due to fear of road danger and difficulty in navigating through the space. Such issues apply mainly within town centres and high streets that blind people visit rather than within lightly trafficked residential access streets.
- 11.11.5 Guidance paving can help to provide a distinct, detectable route for blind and partially sighted pedestrians to follow along the sides of a shared space and does not prevent other pedestrians from sharing the central part of the space. Currently the only confirmed demarcation fully detectable to most blind people and recognised by guide dogs is a footway raised above the carriageway with at least 60mm kerb upstand. Colour, texture and tonal contrast between the carriageway and the footway areas will also help.

11.12 Vehicle restricted areas

- 11.12.1 Commonly used in the centre of towns and cities, Vehicle Restricted Areas (VRAs) are places where motor vehicles are restricted for some or all of the time, often referred to as 'pedestrianised' streets. The main purpose of VRAs is to provide an environment where pedestrians can move around freely without fear and intimidation from vehicles. They are marked by entrance signs which denote either 'Pedestrian Zone' or 'Pedestrian and Cycle Zone' as appropriate as shown in figure 11.8.
- 11.12.2 VRAs will usually be included in active travel route networks, either only for walking, or for both walking and cycling. Because most VRAs are in town centres, they usually serve important destinations and provide one or more direct routes between different parts of the town or city.
- 11.12.3 VRAs may have a level surface to enable pedestrians to use the whole of the street, which is particularly beneficial to people using wheelchairs and mobility scooters. Some vehicular access is usually necessary at certain times, typically for servicing and sometimes for access to car parking spaces for disabled people, or for taxis and/or private vehicles in the evening to support the night-time economy.
- 11.12.4 Larger VRAs can present access problems for older and disabled people if they have to walk long distances from public transport stops or car and cycle parking. Allowing access to disabled car parking spaces or offering mobility scooter hire within the VRA can improve accessibility.

Figure 11.8 – Pedestrian zone signage, Cardiff City Centre



- 11.12.5 Depending on the type and volume of vehicle movements, it may be necessary to denote a vehicle track through the street using a different surface material or planters/bollards. Using kerbs to define the route may restrict pedestrian movements and will suggest that vehicles have priority at the times they do have access. If kerbs are used, regular dropped kerb crossing points should be provided to help visually impaired people.

- 11.12.6 Seating, lighting and litter bins will normally be required. Convenient cycle parking is important, particularly for disabled cyclists, who need to park close to shops and other facilities. All street furniture should be located so that it does not interfere with pedestrian desire lines and is able to accommodate servicing and maintenance vehicles where applicable. Street furniture should contrast with background materials to increase its visibility.
- 11.12.7 Cycling in VRAs can cause concerns to pedestrians, particularly to people with physical, sensory and cognitive disabilities who may not expect cyclists to be present, and this issue can therefore be contentious. Central streets are often prime destinations where shops and services are located. Alternative routes often include heavily trafficked gyratory systems or roads used by HGVs servicing shopping areas, and may pose a greater risk to cyclists. Where cyclists are required to travel longer distances via more heavily trafficked routes around the VRA this will suppress cycle trips and reduce cycle safety. Consideration should therefore always be given to allowing cycling within VRAs (including options for time-restricted access) unless suitable conditions cannot be achieved.
- 11.12.8 Both pedestrians and cyclists may express a preference for clearly-defined cycle routes. However, this can lead to higher cycle speed and greater potential for conflict with pedestrians. Careful urban design can help to create an attractive and functional environment in which cycle speed is low and pedestrians clearly have priority. The positioning of features such as trees and benches and the use of surfacing materials can suggest a preferred route for cyclists. This approach can help keep cyclists away from areas where pedestrians are likely to be moving across their path, such as near shop doorways, seating areas and children's play areas. Street furniture within VRAs should not compromise visibility to the extent that it becomes hazardous for pedestrians and cyclists.
- 11.12.9 Research into the level of conflict between cyclists and pedestrians was carried out in London in 2014². This study found that cyclists alter their behaviour according to the density of pedestrian traffic and extent of the conflicting movements – as pedestrian flows rise, and where the direction of movement is most varied, the incidence of cyclists choosing to dismount also rises and those cyclists who continue to ride do so at a lower speed.
- 11.12.10 If cycling is prohibited within a VRA for all or part of the day the alternative routes for cyclists should offer equivalent coherence, directness, safety, comfort and attractiveness and meet the minimum design requirements for an active travel route.
- 11.12.11 Restrictions on cycling may only be required at certain times of day. Permitting cycling before 10am and after 4pm allows commuter cycling while avoiding the busiest periods of pedestrian activity. A period when no cycling is permitted is also beneficial to people who wish to be certain of a vehicle-free space for their personal safety. Cycling should not be restricted during times when motor vehicles are permitted even if only for deliveries.

11.13 Reallocation of road space

- 11.13.1 The reallocation of road space from motor vehicles to active travel modes not only creates better conditions for walking and cycling but also makes a statement that active travel is considered to be at least as important as motorised travel. Typically this will involve one or more of the following:

- removal of one or more general traffic lanes
- reduced width of general traffic lanes
- removal of centre line
- removal or relocation of car parking
- pedestrian-friendly streets with wider footways or informal footway areas protected by features such as planters and bollards within a level surface

Figure 11.9 – Reallocation of road space using light separation features, Ystrad Mynach



11.13.2 Significant kerb line changes may require costly alterations to drainage arrangements, but will sometimes be necessary to properly reallocate road space so that the needs of pedestrians and cyclists are met. Early engagement with statutory undertakers can help reveal potential issues or opportunities.

11.14 Separation of cyclists and pedestrians

11.14.1 Cyclists using off-carriageway tracks, in green spaces and alongside highways, will usually need to interact with pedestrians. The two possible approaches to the design of links where pedestrians and cyclists are using the same route are:

- cyclists and pedestrians each have their own separate space
- cyclists and pedestrians share the same surface

11.14.2 Early consultation with relevant interested parties, such as those representing disabled people, walkers and cyclists, should form part of the development process to inform design decisions. Schemes should also be monitored post-installation, including contact with user groups who may have opposed the scheme to see whether their concerns have been addressed, or whether some additional mitigation is required.

Table 11.3 – Advantages and disadvantages of separation

Advantages of effective separation	Disadvantages of separation include
Cyclists can maintain a consistent and comfortable speed	Territorial behaviour by users may increase conflict
Cyclists less likely to encounter pedestrians engaged on 'exchange' activities – e.g. playing, shopping	Pedestrians walking in groups (especially at weekends and school journeys) are likely to ignore separation unless widths are adequate
More comfortable for pedestrians who may not expect the presence of cyclists	More expensive to construct and require more land
Less intimidation for vulnerable pedestrians, particularly the visually impaired	May be more visually intrusive in sensitive areas
Reduced perception of conflict by both groups	
Keeps cyclists away from driveways as the cycle track is usually located next to the carriageway	

11.14.3 For separate paths to operate effectively, there must be adequate width for each user group, and the means of separation should be effective. If levels of non-compliance are anticipated to be high due to inadequate space for effective separation, options include:

- Increasing the path width
- providing a shared track
- providing an alternative route for cycling

11.14.4 The following should be considered with regard to the need for separation:

- Pedestrian and cycle flow (both the volume and any conflicting directions of movement)
- cycle speed
- cycle journey purpose
- visibility
- whether significant numbers of vulnerable users are expected – elderly, disabled, children
- available width and any pinch points e.g. bridges
- adjacent activity – shopping, playing etc

11.15 Type of separation

- 11.15.1 Design features such as contrasting materials, a grass verge (see figure 11.11), or a change in level can be used but consideration of how pedestrians may need to cross the cycle track should be taken into account. Materials that provide good tonal and texture contrast will help users to differentiate the cycle and pedestrian surfaces and are valuable for visually impaired pedestrians. This could, for example, be using asphalt for cyclists and light coloured pavements for pedestrians.

Figure 11.10 – Separated pedestrian and cycle provision. (Note also the use of 45 degree kerbs to extend the useable width of the cycle track).



- 11.15.2 Separation using a raised white line marking to TSRGD diagram 1049B to separate pedestrians and cyclists is not well observed, and therefore not recommended.
- 11.15.3 Where cycle tracks are provided at the same level as a pedestrian route, they should be clearly designed and marked as cycle tracks.

11.16 Shared use

- 11.16.1 For the purpose of this document shared use is defined as a route or surface which is available for use by both pedestrians and cyclists, without any physical separating features or markings. Within the highway, it is normally created by converting the footway using the power in section 65 of the Highways Act 1980.

Table 11.4 – Advantages and disadvantages of shared use

Advantages of shared routes	Disadvantages of shared routes include
More flexible use – for example, cyclists may be the majority group during the weekday peak, and pedestrians in groups during weekend	Potentially intimidating for pedestrians, particularly visually impaired people, and especially with high volumes of cyclists
Routes with a wide single surface are better able to accommodate larger cycles, such as those used by disabled people, and people in wheelchairs	Can be frustrating for cyclists who have to limit their speed to accommodate pedestrians
Routes may be cheaper to construct and maintain due to less complex engineering and a narrower overall width	Normal ‘rules of the road’ such as keep left are not observed so it can be hard to predict others behaviour during interactions
Routes may require fewer signs and markings, thereby reducing visual intrusion and maintenance costs	
Can be a useful way of accommodating many different movement types especially at crossings, bus stops and complex junctions	

11.16.2 In urban areas, the conversion of a footway to shared use should be regarded as a last resort. Shared use facilities are generally not favoured by either pedestrians or cyclists, particularly when flows are high. It can create particular difficulties for visually impaired people. Actual conflict may be rare, but the interactions between people moving at different speeds can be perceived to be unsafe and inaccessible, particularly by vulnerable pedestrians. This adversely affects the comfort of both types of user, as well as directness for the cyclist.

11.16.3 Where a shared use facility is being considered, early engagement with relevant interested parties should be undertaken, particularly those representing disabled people, and pedestrians and cyclists generally. Engaging with such groups is an important step towards the scheme meeting the authority’s Public Sector Equality Duty.

11.16.4 Shared use may be appropriate in some situations, if well-designed and implemented and some examples include:

- alongside inter-urban and arterial roads where there are few pedestrians
- at and around junctions where cyclists are generally moving at a slow speed, including in association with Toucan facilities
- in situations where a length of shared use may be acceptable to achieve continuity of a cycle route
- in situations where high cycle and high pedestrian flows occur at different times

11.16.5 Recommended minimum widths of shared use routes carrying up to 300 pedestrians per hour are given in table 11.5. Wherever possible, and where pedestrian flows are higher, greater widths should be used to reduce conflict where full separation can't be provided.

Table 11.5 – Recommended minimum widths for shared use routes carrying up to 300 pedestrians per hour

Up to 300 cyclists per hour	3.0m
Over 300 cyclists per hour	4.5m

11.16.6 Designers should be realistic about cyclists wanting to make adequate progress. The preferred approach for shared use routes is therefore to provide sufficient space so that cyclists can comfortably overtake groups of pedestrians and slower cyclists.

11.16.7 Research shows that cyclists alter their behaviour according to the density of pedestrians – as pedestrian flows rise, cyclists tend to ride more slowly and where they become very high cyclists typically dismount. It should therefore rarely be necessary to provide physical calming features to slow cyclists down on shared use routes.

11.17 Pedestrian routes and links DE101 and DE102

11.17.1 Pedestrian routes include footways adjacent to carriageways (DE101), footpaths away from roads, such as paths through housing estates, parks and alongside waterways (DE102) and other elements of Public Rights of Way. Where footways or footpaths are being designed as a shared use path for pedestrians and cyclists (separated or unseparated) refer to DE401, DE402 and DE403.

11.17.2 Walking routes should follow direct desire lines as closely as possible, be of sufficient width for the level of use, and gradients should be accessible to all users.

Widths

11.17.3 The required width of a footway or footpath will depend on the pedestrian flows and whether a separating margin is needed due to high traffic speed or large vehicles on the adjacent carriageway.

11.17.4 Minimum widths are given in chapter 9 and summarised in DE101 and DE102. Where pedestrian flows are very high, a detailed assessment of pedestrian capacity and comfort should be made (see TfL Pedestrian Comfort Guidelines, summarised in chapter 10). If there are high levels of static pedestrian activity such as near tourist attractions, high streets and public spaces additional space will be needed.

11.17.5 Footway widths may be increased by reallocating carriageway space and/or removing or rationalising street clutter. Removing unnecessary street furniture and locating remaining furniture in an area out of the main pedestrian flow helps remove hazards for visually impaired people and can improve the street appearance.

11.17.6 Litter bins and other potential obstructions should have a minimum height of 1.0m and be continuous to the ground rather than sited on posts. DE101 provides guidance on the need for hazard protection to isolated objects.

- 11.17.7 Footway parking can be prohibited with a TRO to enable enforcement if necessary. Physical measures, such as bollards, raised planters or other street furniture along the edge of the footway can prevent unlawful access, while positive provision of marked parking bays can encourage compliance. Additional width of the footway may be required to take into account the lost space used by the physical measures.

Figure 11.11 - Cycle track and pedestrian footway alongside road, separated by grass verge



Build-outs

- 11.17.8 Build-outs can provide additional footway width at particular features such as bus stops, and may also provide a traffic calming effect. Build-outs at pedestrian crossings reduce the crossing width and enable pedestrians to wait in a more visible position.
- 11.17.9 Build-outs should not create the critical carriageway width for cyclists as defined in chapter 9, section 9.21. Consideration should be given to the provision of cycle bypasses, as shown on DE203. If no bypass is provided, the angle taper for a build-out will gradually force a cyclist out into the primary position in the path of other vehicles and should be no greater than 1 in 10.
- 11.17.10 A build-out should be conspicuous in both daylight and darkness, using a reflective or illuminated bollard.

11.18 Gradients, ramps and steps DE103 and DE104

- 11.18.1 The longitudinal profile of a footway adjacent to a carriageway should generally follow its vertical alignment, although there may be situations where a footway can usefully be maintained on a steady vertical profile while the carriageway goes through a sharp dip or crest. In these situations, a retaining wall or slope between the carriageway and the footway will be necessary.

- 11.18.2 The gradients of footways, footpaths and shared use routes should accord with the guidance given in chapter 9, summarised on DE103.
- 11.18.3 Ramps and steps to facilitate a sharp change in level or grade should not be used on a walking route unless it cannot be avoided. The design of ramps and steps is shown in DE103 and DE104.
- 11.18.4 Steps should normally be provided in conjunction with a ramp to provide accessibility for mobility impaired pedestrians. Steps can offer a useful shortcut to maintain desire lines to accommodate a change in level or grade. Steps should have clearly visible nosings/edges, handrails to both sides, and corduroy warning paving to the top and bottom. Visual contrast between elements will help highlight features such as edges and handrails.
- 11.18.5 Existing steps on active travel routes should be assessed against DE104, with improvements made if necessary.

11.19 Wheeling ramps DE105

- 11.19.1 Flights of steps are sometimes unavoidable where a cycle route has been introduced on a historic path, or where cycle access is needed over a bridge, for example at a station. Wheeling ramps should be added to one or both sides of the flights using steel sections or by forming them in concrete. These facilities will be inaccessible to some cycle users and an alternative route avoiding the steps should be signed where available.
- 11.19.2 Care should be taken in positioning the wheeling ramp. The ramp should be far enough away from the side-wall to allow cyclists to use it without the side-wall snagging their handlebars (including cycles with wide handlebars), but not so far out as to impede pedestrians from using the hand-rail. In practice, the wheeling ramp should normally be directly below the hand-rail, with enough height difference between them for a bicycle, angled slightly outwards, to fit beneath the hand-rail.

11.20 Traffic lane widths and car parking

- 11.20.1 Designers will need to consider the widths of general traffic lanes and parking spaces when designing active travel routes and reallocating space. Designers will need to assess the minimum width requirements of moving and stationary vehicles, and when cyclists are sharing the carriageway, how the lane widths relate to the recommended riding positions.

Lane Widths

- 11.20.2 Traffic lane widths of 3.65m (metrication of 12 feet) have often been provided as standard in the United Kingdom, but lane widths of 3.0 metres have been used in many parts of the country on urban roads for some time, and can accommodate most typical vehicles (including HGVs) at speeds up to 40mph.
- 11.20.3 Widths for trunk roads are given in DMRB CD127, although it should be noted that CD224 permits lane widths as narrow as 2.25m in certain circumstances on the approaches to traffic signal stop lines. Further guidance on traffic lane widths is given in Manual for Streets 2. Care must be taken where a high proportion of HGV traffic is expected to allow sufficient space for cornering and for oncoming HGVs to pass one

another. It should also be noted that the mirrors on modern HGVs now extend further out from the vehicle so the minimum lane widths should not be used on roads where oncoming HGVs will meet frequently.

- 11.20.4 Streets where large vehicles are uncommon and speeds are modest (less than 35mph) can accommodate car traffic comfortably within a 2.75m lane. Larger vehicles can pass each other at this width at lower speed with care, but drivers may need to encroach slightly outside of lanes to pass.
- 11.20.5 Where lane widths are in the critical range of 3.2m to 3.9m given in chapter 9, conditions will be unsuitable for cycling on the carriageway unless traffic speeds and volumes are low enough that drivers can usually cross easily into the opposing lane to pass a cyclist comfortably.

Car Parking Width

- 11.20.6 Parked vehicles ideally require a standard width of 2.4m for a parking space but in practice this is often difficult to accommodate in existing streets. 2.0m is the preferred minimum – this still provides a margin of error for poorly parked vehicles. Widths between 1.8m and 2.0m are only recommended if space constraints require such narrow widths.
- 11.20.7 Cyclists are taught to ride well clear of parked cars to avoid collisions with opening car doors, and cycle lanes should be separated from car parking by a buffer zone (at least 500mm) for that reason.

11.21 Contraflow cycling DE301 and DE302

- 11.21.1 One-way streets and gyratory systems for traffic management are commonplace. One-way streets can significantly reduce the density of the cycling network and some cyclists may then elect to travel illegally against the flow of traffic, or do this on the footway.

Figure 11.12 – Light separated cycle contraflow



11.21.2 The permeability for cyclists can be greatly enhanced by exempting them from one-way restrictions, and encourages active travel with connections unavailable to motorised traffic. Retaining two-way cycling should be considered if it is proposed to introduce one-way working for general traffic. The operation of existing one-way streets should be reviewed with a view to permitting two-way cycling wherever safe and practicable. The design should consider the possible impact on pedestrians and whether they can anticipate that cyclists will be travelling in both directions or whether additional signs are needed at crossing locations.

11.22 Cycle lanes DE303 and DE304

11.22.1 Cycle lanes on the carriageway are reserved either exclusively or primarily for the passage of cyclists. Many people feel uncomfortable sharing the road with motor traffic and table 11.1 provides guidance on when cycle lanes may be suitable.

11.22.2 The design of cycle lanes requires attention to the turning movements of cycle traffic and other traffic:

- cyclists are not physically protected, and it is important that traffic speed and volume is appropriate for cyclists to use the carriageway
- cycle lanes may conflict with other kerbside activities such as parking bays, loading bays, taxi ranks and bus stops. Attention to these design issues (such as inset parking and loading bays, and bus stop bypasses) will help minimise conflicts and hazards

11.22.3 Mandatory lanes are marked with a continuous white line which must be supported by a TRO to enforce restrictions on parking in the lane. There can be exceptions, such as for emergency service vehicles and access to private driveways, and time limits.

11.22.4 Advisory lanes are marked with a broken white line that indicates motor vehicles should not enter unless it is safe to do so. Mandatory lanes should be used instead of advisory lanes except where the narrowness of the road makes it impossible to install a cycle lane without allowing vehicles to encroach into it when no cyclists are present. Parking restrictions should apply at all times unless there are clearly justified reasons not to do so.

11.22.5 Raised thermoplastic markings can be used to help deter incursion by motor vehicles.

11.22.6 Cycle lanes are an integral part of active travel networks, but due to the limited protection which they offer, highway authorities are encouraged to consider light separation features in the design of new schemes to offer greater physical protection to cyclists, in line with the core design principles.

11.23 Car parking/loading and cycle lanes DE305

11.23.1 Kerbside vehicle parking or loading can often be dangerous for cyclists especially in a street with high vehicle turnover rates as there is a high risk of vehicle doors being opened into the path of cyclists within the cycle lane. It is therefore necessary that any cycle lane must pass parking areas with a sufficient dividing strip (buffer zone) or else be of sufficient width to enable cyclists to travel in the cycle lane away from the parking. Inset bays or build-outs may help protect space for cyclists.

11.24 Cycle lanes at side roads DE306

- 11.24.1 Cycle lanes across side road junctions ensure continuity and help improve cycle safety. Continuous mandatory cycle lanes across side road junctions are not permitted. A road marking to diagram 1010 can be used to mark the lane at the junction mouth (1m line, 1m gap) as in TSRGD 2016. A cycle symbol to diagram 1057 may also be placed within the lane at the junction mouth.
- 11.24.2 Increasing the cycle lane width at side roads can help encourage cyclists to position themselves further from the kerb to avoid vehicles nosing into the main road, or turning left across the cyclist. Side road entry treatments help reduce the speeds of vehicles turning in and out of the junction.

11.25 Cycle lanes with removal of centre lines DE307

- 11.25.1 The removal of centre lines is useful where carriageway widths would not otherwise permit the introduction of cycle lanes, and as a speed reduction measure.
- 11.25.2 Where on-coming motor vehicles have to pass each other, both vehicles momentarily pulling over into their respective near-side advisory cycle lanes, having first checked to see they are clear of cyclists. For this reason a maximum two-way flow of around 4500 motor vehicles a day, or 500 per hour at peak times is recommended. With more traffic there is higher risk of conflict with cyclists

Figure 11.13 – Centre line removal to allow advisory cycle lanes, Penarth



11.26 Cycle lanes with light separation DE308, DE309 and DE310

- 11.26.1 A mandatory cycle lane along the side of a road may be reinforced by light separation from the main carriageway, using a variety of intermittent low-level physical features such as planters, wands (retro reflective collapsible bollards), and other features usually constructed from PVC or recycled rubber. The intermittent obstacles enable cyclists to pass between the cycle track and the carriageway as necessary, to turn right for example. Existing drainage can still be used so the installation cost is minimal compared to conventional kerbed facilities. The creation of any potential trip hazards for pedestrians should be avoided and sufficient space should be allowed for around formal crossing points and at junctions.
- 11.26.2 The features are not road markings and therefore no authorisation is needed from Welsh Ministers. They are bounded by the solid white line of a mandatory cycle lane, and should be marked with a broken white line at junctions. A vertical feature such as a bollard or wand should be used at the beginning and end of each run to ensure they are visible to road users and to help avoid damage to the separators.

Figure 11.14 – Two-way cycle lane using light separation



11.27 Stepped cycle lanes or tracks DE311 and DE312

- 11.27.1 Stepped cycle tracks have a cycle facility raised slightly above the carriageway surface but sitting below the level of the footway. This type of solution is common in Copenhagen, and it has been used in Brighton, Cambridge, London, Newcastle and Salford in England.

Figure 11.15 – Stepped cycle track, Cardiff



11.27.2 The position of the track immediately next to the main carriageway means that transitions between a cycle lane and a stepped cycle track (and vice versa) are simple and comfortable for the user.

11.28 Cycle tracks alongside the carriageway DE313

11.28.1 Table 11.1 illustrates where separation from motor traffic is necessary to provide cyclists with safe and comfortable conditions.

11.28.2 Cycle tracks by the carriageway should be of adequate width, comfortable, continuous and link into surrounding cycling infrastructure. In most urban locations the conversion of footways to shared use should be the last resort, but this may be appropriate in suburban and rural areas with few pedestrians or adjacent building entrances.

Figure 11.16 – Cycle track adjacent to the carriageway, separated from pedestrians



11.28.3 Cycle tracks alongside the carriageway can be either be two-way or one-way. Two-way tracks are usually provided only on one side of the road, unless it is difficult for cyclists to cross major highways. One-way tracks are usually provided on both sides of the road in the same direction as adjacent traffic lanes. Most cycle tracks in the UK have been built as two-way, but in busier locations this can create some difficulties for users:

- retaining priority over side roads/busy accesses is more difficult and it is hard for all drivers and cyclists to see one another
- greater conflict with vehicles at private accesses
- complexity of design of crossings at traffic signal junctions and roundabouts
- difficulty of linking with adjoining cycle network at each end of the scheme
- poor accessibility to development along the route on the opposite side
- conflict with pedestrians crossing the carriageway

11.28.4 One-way cycle tracks on each side of the road address many of the above issues.

11.28.5 The recommended widths for two-way cycle tracks are the same as for cycle tracks away from the road, including the extra width where there are kerb edges, sign poles, lamp columns, walls, fences and upstands. A 500mm clear space should be provided on either side of the track to allow the whole width of the route to be used.

11.29 Cycle tracks in centre of carriageway DE314

11.29.1 An option which has been little used in the UK yet is to place two-way cycle tracks in the centre of single carriageway streets, or one way tracks alongside central reservations. This can provide a good facility for cycling along busy highways without encountering obstructions such as bus stops and driveways. Access to and from the central track is critical, and is typically achieved via controlled crossings and at signalised junctions. It will be necessary to ban turns across the central track at side roads, if it is not possible to create a suitable junction. Regular pedestrian crossing facilities will also be necessary.

Figure 11.17 – Cycle track in centre of carriageway, Birmingham



11.30 Transitions between cycle tracks and the carriageway DE315

11.30.1 The transition for cyclists between a cycle track (including a shared use path) and the carriageway should be safe and comfortable. Where the transition is on a link, cyclists should be able to continue along their direction of travel without bumping up and down kerbs, without having to turn sideways to look behind them and without giving way to vehicles on the carriageway. The design of the transition point must ensure that cyclists are clearly visible so that motorists are aware that cyclists are likely to be re-joining the carriageway ahead of them. Some example layouts are illustrated below in figure 11.18.

Figure 11.18 – Example layouts of cycle lane transitions

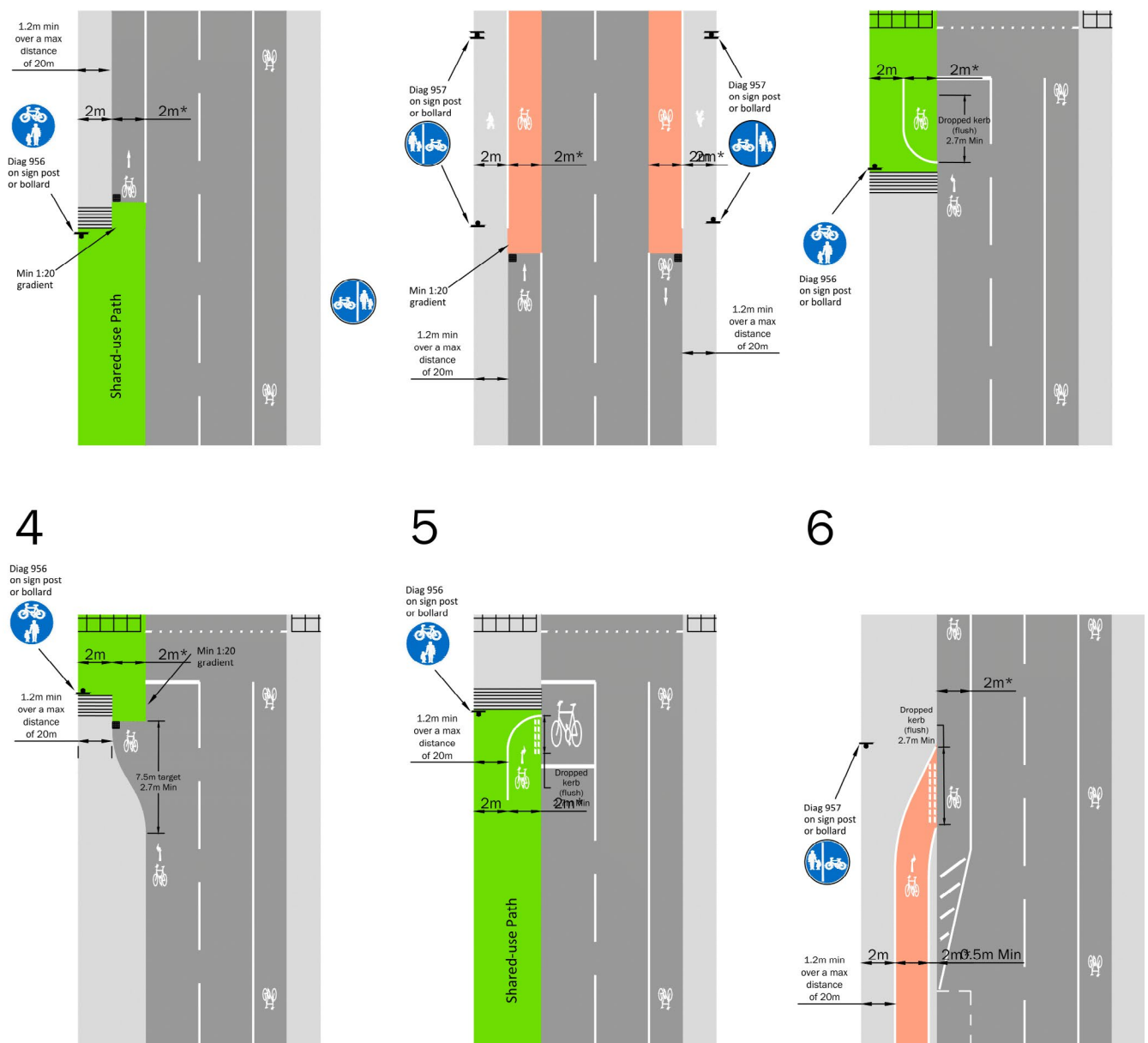

11.30.2 It is preferable to continue the cycle lane with light segregation, even if only for a short section, not least because this prevents the exit-point from the cycle track from being blocked by parked vehicles.

11.30.3 Transitions from a carriageway to a cycle track usually present fewer safety problems for cyclists but should still enable cyclists to continue in a direct line, crossing any (flush) kerbs at right angles.

Figure 11.19 – Transition from cycle track to cycle lane, Liverpool



Figure 11.20 – Flush kerb



11.30.4 The type and quality of construction of the kerbs is particularly important if the kerb is to be crossed at a shallow angle, although designs should aim to modify kerb lines so that cyclists cross them at 90 degrees. Figure 11.20 show examples of a flush kerb. Alternatively, a smooth tarmacadam ramp may be used to create a seamless transition without kerbs.

11.31 Cycle lanes/tracks at bus stops DE501, DE502, DE503 and DE504

11.31.1 People using cycle lanes and cycle tracks adjacent to the carriageway will either pass a bus on the off-side, with potential conflict with buses and passing traffic, or on the footway side, with potential obstructions by street furniture and conflict with waiting/alighting pedestrians at the bus stop.

11.31.2 No standard layout for cycle lanes/tracks at bus stops can address all considerations but there is a wide range of possible layouts. Each site will need considering on its own merits taking the following points into consideration:

- ensuring there is available space for cyclists to pass a stationary bus (either in the carriageway or to the footway side of the bus stop) so that momentum is maintained
- making it clear that cyclists must adjust their behaviour and speed to avoid conflict with pedestrians around bus stops
- adequate space for pedestrians to wait for the bus where they do not pose an obstruction to any cycle bypass

- sufficient safe space within a bus stop island for a wheelchair and helper to alight and turn
- good intervisibility between pedestrians (those waiting for a bus as well as those passing) and cyclists, to minimise potential for conflict
- clear routes to and across the cycle track crossing for visually impaired pedestrians
- the number of passengers waiting/alighting, frequency of bus service and flows of cyclists, traffic conditions and available space will determine the best design solution

11.31.3 The five possible options covered on the Design Elements sheets for minimising conflict with pedestrians and buses are:

- cycle lane terminates at bus cage (on road bus stop markings), with alternative route past stop highlighted
- cycle lane continues around bus stop, possibly in conjunction with a bus bay
- cycle lane/track runs across bus boarder
- cycle track bypass to rear of bus stop
- separate cycle and pedestrian paths terminate to become a shared use area at the bus stop, with cyclists giving informal priority to pedestrians

Figure 11.21 – Bus stop bypass



11.32 Pedestrian and cycle tracks, away from road DE402 and DE403

11.32.1 Routes away from motorised traffic are referred to as traffic-free routes or greenways. They are usually shared surface but may be separated where the space and budget is available. Routes can be developed in urban, urban fringe and rural areas in a wide range of linear corridors but should offer good connectivity to other parts of the network to achieve high usage.

11.32.2 Common types of traffic free routes include:

- urban parks
- disused railway alignments
- seaside promenades
- canal and riverside tracks
- river and coastal flood banks
- footpaths and bridleways
- amenity spaces such as golf course, racecourses, stately homes
- abandoned road alignments
- public open spaces within existing and new developments

11.32.3 Key elements of successful traffic-free routes include:

- routes should be direct and follow desire lines wherever possible, avoiding steep gradients
- route capacity and widths should be adequate for peak forecast demand conditions
- minimum visibility and corner radii should be provided, based on the appropriate design speed
- good quality surface materials should be used
- routes should have good lighting, drainage and be maintained well, including vegetation clearance

11.32.4 Restrictive access controls, vegetation growth that encroaches on the track surface, poor or inadequate lighting, poor sightlines or poorly maintained track surfaces will deter users.

11.32.5 Equestrians should not be denied access to routes that they currently have the right to use by changing the classification of the rights of way. There needs to be clear signing of which routes are intended for use by equestrians. If widths permit, a separate unsealed surface may be preferable for equestrians.

Design and construction of routes away from the highway

11.32.6 Traffic-free routes and greenways are popular active travel and leisure routes and the design and construction process should consider:

Design

- the connections between the corridor and the wider network;
- the types, journey purpose and future volumes of users
- the available track width and any constraints
- the horizontal track alignment and any visibility constraints; and
- gradients and accessibility

Construction

- formation and sub-base
- surface dressings suitable for utility cycling
- edges and verge treatments
- drainage
- lighting
- ancillary works

Widths

11.32.7 The track width should be able to comfortably accommodate the current, forecast and any target increase in users, including from planned land-use development. A width greater than the minimum will increase the level of service, permit sociable (side by side) cycling and walking, and accommodate future growth in active travel.

11.32.8 Cycle tracks should include additional width where they are bounded by vertical features because it is only practical to use the whole track width to cycle where there is open space alongside.

Junctions between traffic free routes

11.32.9 Speed control measures should be avoided where possible through careful design as they can be a barrier to users.

11.32.10 Cycles cannot turn right angles, and pedestrians will usually cut a corner, so providing a radius that enables cycling speed to be maintained and accommodates the track of larger cycles will also help prevent erosion of 'desire lines' in adjacent grassed areas. Blind and partially sighted pedestrians use the path edges and turns to aid navigation so additional guidance may be needed to help them at junctions. Junctions between cycle tracks should normally have a minimum 2.0m curve radius or 45° chamfer.

Speed control measures

11.32.11 Speed control measures should be avoided where possible through careful design as they can be a disincentive to users.

11.32.12 Excessive speed by cyclists can be an issue on downhill gradients and on bends where constraints prevent minimum stopping sight distances being provided. Warning signs may have some effect but may need to be complemented by physical measures.

11.32.13 Away from the carriageway, speed control may be integrated into public art using sculptures or landforms to create horizontal and vertical features. Speed control options include:

- speed humps
- bollards, including staggered layouts
- chicane-type deviations
- rumble strips
- signs/markings

11.32.14 The design considerations for speed control measures on cycle tracks also effect pedestrians and section 15.3 must be considered, specific issues include:

- Accessibility
 - » accessibility must be maintained for all legitimate users, including all types of cycle, pedestrians and wheelchair/mobility scooters
 - » a restriction in track width will slow down users as they negotiate it but also introduces a different type of potential conflict point where users have to give way to one another
 - » barriers often cause access problems for people with disabilities and should generally be introduced as a last resort
- Siting of speed control measures
 - » careful consideration should be given to the location and distance between speed control measures so that they do not impede progress or create additional conflicts between users.
- Visibility
 - » the feature may present a hazard to users and should be clearly visible in daylight and darkness.
- Maintenance vehicle access
 - » does the track require vehicular access for maintenance?
 - » can any locking mechanisms be suitably managed and maintained?
- Prevention of bypassing
 - » bypassing must be prevented or at least not be easier than passing through the speed control measure.
- Speed humps
 - » speed humps profiles must be constructed to acceptable tolerance. DE202 provides details of the preferred sinusoidal hump profile

- » precast concrete products are available but may be prohibitively expensive, and without a flat base they can also rock and create a trip hazard
- » speed humps on slopes should not increase the gradient of the hump beyond the absolute maximum 1 in 12

11.32.15 Further information on traffic-free routes is available from [Sustrans: Traffic-Free Routes and Greenways Design Guide](#).

11.33 Cycling on rural roads

- 11.33.1 Most cycling takes place in urban areas, but roads outside built-up areas provide key links for cyclists who live in rural areas making journeys to local destinations or nearby urban areas, as well as leisure cycling.
- 11.33.2 Cycling on rural roads can feel hazardous due to higher traffic speeds, restricted visibility and narrow carriageways. Measures to reduce motor traffic speeds and volumes may be implemented to help reduce the risks to cyclists and pedestrians.
- 11.33.3 On-carriageway active travel cycle routes in rural areas should generally follow roads with low traffic flows, preferably below 1,000 vehicles AADT and with actual traffic speeds no greater than 30mph (see table 11.1). The design of cycle routes should be sympathetic to the local environment with limited use of intrusive signing and road markings.

Figure 11.22 – Quiet lane signage Figure 11.23 – Speed control measure at quiet lane



- 11.33.4 The rural active travel experience can be improved with design features that aim to make rural roads safer and more pleasant places to travel by foot and cycle.

Gated closures/restrictions

- 11.33.5 Closing or restricting access to motor traffic on minor roads is an effective way of improving conditions for walkers and cyclists. Simple measures can be introduced, such as a mode-filter with a cycle gap, or direction signs leading through traffic away from minor roads used by the active travel routes. Local engagement and consultation on TROs will be required and the maintenance of these routes should also be considered.

Changed priorities – junction redesign

11.33.6 Where two minor roads intersect (i.e. with two-way traffic flows less than 1,000 vehicles per day on each arm), the road with the major cycle flow can be given priority. This can often be achieved simply by relocating give-way markings and signs, but it may be necessary to undertake works to improve or maintain the visibility splays.

Reduced speed limits

11.33.7 Most of the rural road network is subject to the national speed limit of 60mph. The geometry of many rural roads is inadequate for this speed, and where an active travel route is being promoted, speed limits should be reduced.

11.33.8 Speed limit reductions alone are unlikely to substantially reduce average speeds without additional physical measures, especially at approaches to isolated hazards, junctions and bends.

Centre line removal

11.33.9 Centre lines can increase traffic speeds since they help guide motorists and give them greater confidence to negotiate oncoming traffic. Removing centrelines on lightly trafficked roads can typically help reduce average speeds by up to 3mph, and may form part of an overall strategy to improve safety.

11.33.10 The introduction of motor traffic restrictions (e.g. signed HGV alternative routes, and/or weight & width restrictions) can help reduce traffic volume to create suitable conditions for centre line removal.

Gateway treatment

11.33.11 Gateways (usually a vertical sign or gate on each side of the road) are used at a village boundary to raise driver awareness of an approaching settlement where drivers are expected to reduce speed. Lower speed limits and physical traffic calming are often used to help enforce this measure.

11.33.12 Gateways can sometimes form pinch points for cyclists, especially hazardous if traffic speeds are still above 30mph. Where pinch points are intentionally created, cycle bypasses should be provided, see DE203.

11.33.13 Gateways do not have to take the form of a pinch point as they can be subtly created by using planting, different road colours/materials and other visual changes that mark the contrast between high speed roads and low speed villages.

11.34 Temporary infrastructure

11.34.1 During 2020 the Covid-19 pandemic highlighted how quickly the transport environment can change and using temporary infrastructure allows local authorities to introduce measures to improve the safety and conditions for sustainable and active travel modes in their area to achieve sustained changes in travel behaviour in the future.

11.34.2 Introducing temporary measures to protect public health and safety and to enable people to choose the healthiest and most sustainable transport modes for shorter everyday journeys now and in the future can be a useful tool to test new infrastructure prior to re-designing whole streetscapes. Engagement and monitoring should be included from the concept stage of any project and be a key part of any development opportunity, temporary schemes should follow the same principles of permanent schemes, see chapter 8 (Engagement) and chapter 16 (M&E).

11.34.3 Engagement is also needed to ensure that effective consideration is undertaken and provision for protected groups maintained (and improved). Early engagement should be a priority to assist with any TROs that may be required as part of the scheme and will allow local communities to get involved in the early stage designs.

11.34.4 Street design plays a key role in enabling people with protected characteristics to get around with confidence and local groups and representatives should be involved from the early design stage.

11.34.5 General design approaches to consider when designing for temporary infrastructure are the same as more permanent approaches.

Table 11.6 – Examples of temporary Covid-19 infrastructure



Reducing speed and volume of motor vehicles



Filtered permeability



Reallocation of road space



Vehicle restricted areas



Temporary pedestrian priority

11.35 Cyclists and public transport routes

11.35.1 Chapter 13 focuses on the opportunities and benefits of integrating active travel modes with public transport operations. The design considerations to address where cycle routes interface with public transport routes are discussed below.

Mixed cycle traffic on bus routes

11.35.2 Table 11.1 illustrates where traffic speeds and volumes are sufficiently low to permit cyclists to share the carriageway with general traffic. Sharing space with buses will not normally be a problem for confident cyclists, subject to appropriate lane widths. Where bus flows are high and form a large proportion of the traffic volume, it is preferable to separate cyclists from buses.

11.35.3 Cyclists are at risk when passing buses at bus stops, from the buses themselves and from other traffic in the adjacent lane. Various measures to assist cyclists are shown in DE501, DE502, DE503 and DE504.

11.36 Bus lanes and bus-only streets DE505

11.36.1 Cyclists are permitted to use with-flow bus lanes unless there is a TRO to restrict them. Whilst not specifically a cycle facility, bus lanes can at least provide separation from vehicles other than buses. Taxis and other vehicles (e.g. motorcycles, goods vehicles) are sometimes permitted in bus lanes which can increase traffic flows and risks to cyclists because other vehicles accelerate and travel more quickly than buses.

11.36.2 In order to be considered suitable to be an designated active travel route, the bus lane should still meet the criteria given in table 11.1 – i.e. a separate cycle lane (and potentially a light segregated track) will be needed in some circumstances for the route to be considered suitable for inclusion on the ATNM Existing Routes map.

11.36.3 Where bus lanes are provided, care should be taken to ensure that provision for cyclists in the opposite direction is not compromised.

11.36.4 Contraflow bus lanes should be of sufficient width to accommodate cyclists. The widths referred to in DE505 for with-flow bus lanes apply. However, for short stretches, or where flows are low, narrower lanes may be acceptable, which will mean that buses will not be able to pass cyclists.

11.36.5 Where bus-only links are provided, for example between two residential neighbourhoods, the design should normally include provision for cyclists as well (either within the busway or adjacent to it).

11.37 Cycling and trams

11.37.1 Only one mile of operational tramway currently operates in Wales. It is important to ensure that any potential future light rail schemes do not compromise the needs of cyclists. There are also a few situations where narrow-gauge railway lines cross or travel along the carriageway.

Figure 11.24 – Cycle route crossing heritage railway tracks which run along the carriageway



11.37.2 Cyclists and trams can share the same carriageway but this requires extra care during the design phase, principally to make sure cyclists do not cross the rails at too shallow an angle (on links and at junctions); typically the approach angle should be at least 45 degrees, preferably 60 degrees. Rails embedded in the carriageway contribute indirectly to hazards including:

- cyclists may be concentrating on avoiding the rails and fail to notice other hazards
- cyclists are not always able to choose a safe path
- rails restrict the scope for evasive manoeuvres to avoid other traffic danger

11.37.3 A mix of tram, car and cycle in the carriageway is not appropriate for active travel routes unless there are no alternative route alignments.



Chapter 12: Designing for active travel junctions and crossings

This chapter provides guidance on the design of junctions and crossings. Section 9 (1) of the act means that highway authorities need to consider how they can improve the conditions for walkers and cyclists when they construct or change junctions. Section 2(6) of the act requires local authorities to have regard to this guidance when determining whether a junction or crossing is suitable to be designated as part of an active travel route.

Key areas of consideration include:

- on active travel routes, junctions and crossing design should favour priority for pedestrians and cyclists over vehicles
- the key principles of directness, safety and comfort should guide the design of new junctions
- reducing vehicle speed and capacity (for example by reducing the number of lanes) at junctions should be considered as well as the provision of well designed active travel crossings and facilities
- early engagement with groups representing people with sight loss and other disabilities is essential, particularly where unusual or uncontrolled crossings are proposed

12.1 Introduction

12.1.1 This chapter provides advice on the design of junctions and crossings which meet the needs of pedestrians and cyclists, in urban and in rural situations. As with route and link design (chapter 11), it should be considered in conjunction with the information in chapter 13, 14 and 15. References to the relevant design elements in Appendix G are included.

12.1.2 A junction is where two or more roads or active travel routes meet, with a crossing provided to give pedestrians and cyclists safe passage across the carriageway. The type of junction or crossing provided will need to be appropriate to the circumstances of the site and the behaviour and needs of the users.

12.2 Crossing and junction design – general principles

12.2.1 The design of junctions and crossings must be comprehensible to people walking, cycling, riding or driving. Directness, safety and comfort are significant for active travel at junctions and crossings. For many potential users, their willingness to use the entire route will be determined by an assessment of whether they feel safe using the junction or crossing. Designers must therefore give considerable thought to ensuring the best layout is achieved or the entire route risks failing to convert new users.

Directness

- 12.2.2 Directness at junctions involves both distance and time delay. There is a trade-off in separating pedestrian and cycle movements from other traffic for safety reasons which may introduce additional delay for everybody.
- 12.2.3 Where possible pedestrian and cycle route design should avoid arrangements that require frequent stopping and starting.
- 12.2.4 Delay at a junction or crossing increases journey time for pedestrian and cycle traffic, by both real and perceived inconvenience of stopping. Setting the timings of signal-controlled junctions and crossings to reduce delay for pedestrian and cycle traffic may be criticised as reducing capacity for motor traffic but this can be justified within the aim of providing advantage to active travel modes. A balance will need to be struck to optimise performance for all users as far as possible.
- 12.2.5 Routes through junctions that follow natural desire lines will minimise the effort required for walkers and cyclists. Where the provided route is indirect, many users may choose a shorter route rather than the intended formal crossing points, potentially putting themselves at risk and also devaluing the new facility. Understanding desire lines from the outset is therefore very important for achieving a successful design.
- 12.2.6 At side road junctions, deviations from the desire line can be minimised with the use of small corner radii. This also has the benefit of helping reduce vehicle speeds (see figure 12.1).

Figure 12.1 – The effect of corner radii on pedestrians (from Manual for Streets)

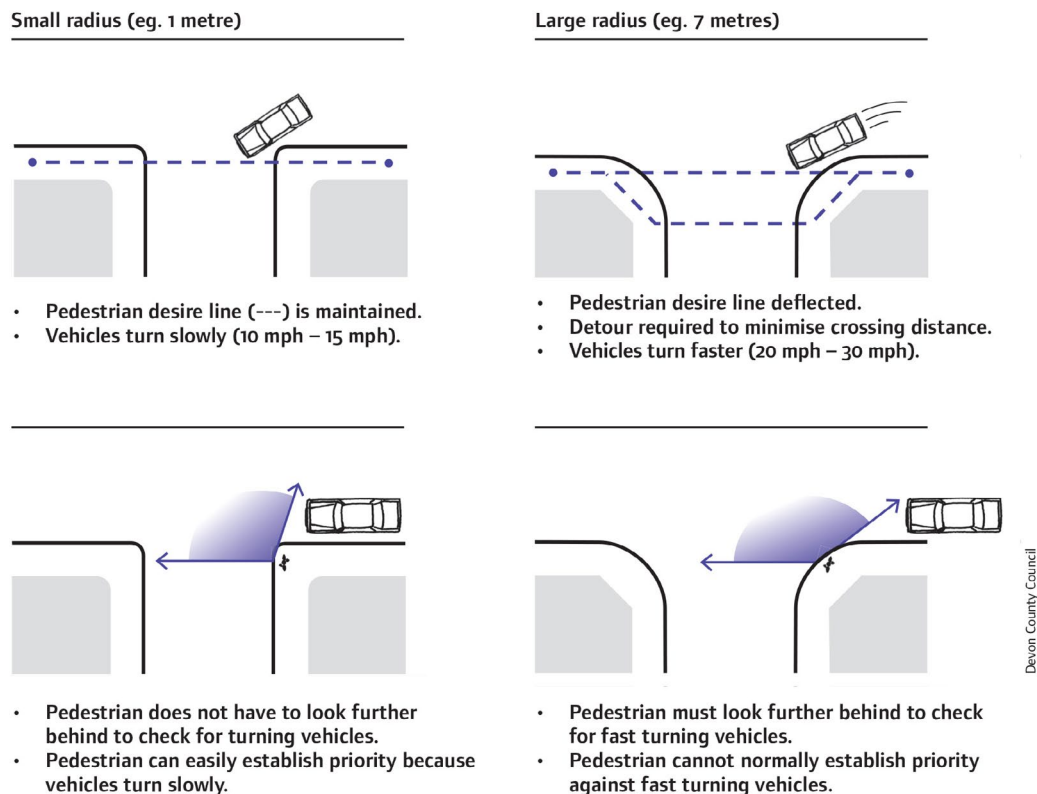

Safety

- 12.2.7 Safe, well designed crossings can help reduce the community severance created by busy roads. Safety is a key consideration because junctions and crossings are a frequent location for accidents and collisions.
- 12.2.8 Cyclists going ahead on a major arm are at risk from vehicles turning in and out of side roads, and some of these risks can be reduced through good junction design.
- 12.2.9 Good design reduces the risk of injury to pedestrians and cyclists by:
- minimising the number of conflicting movements
 - minimising the number of traffic lanes through the junction
 - reducing motor vehicle speeds at potential conflict points – to reduce the number and severity of casualties
 - ensuring good visibility between all road users
 - allowing sufficient signal time for pedestrians and cyclists to complete their movements when they are separated from opposing traffic
- 12.2.10 Signal-controlled crossings and junctions provide safety benefits for pedestrians and cyclists by separating opposing movements in time, further details of which are explained within this chapter.

Comfort

- 12.2.11 Junction and crossing layouts should provide:
- a smooth surface with flush dropped kerbs and appropriate tactile paving
 - careful location of street furniture away from desire lines
 - sufficient space for pedestrians and cyclists waiting to cross
 - minimal need to stop and start at side roads and crossings
 - adequate visibility splays and visibility between users

12.3 Considerations for pedestrian and cycle crossings

- 12.3.1 The ability to cross the road safely has a major impact on people's ability to undertake active travel. Pedestrian and cycle crossings should always be provided where an active travel route crosses a major road, and be located as close to the desire line as possible. Crossings may be placed at junctions or mid-way between other junction arrangements. Active travel crossings are usually incorporated into the traffic signals at signal controlled junctions.
- 12.3.2 Pedestrians may want to cross the road at any point along a shopping street due to the way they interact with the retail services. Consideration should be given to providing informal crossings at additional regular intervals to supplement the provision of signal-controlled crossings.

- 12.3.3 Delays to pedestrians and cyclists on active travel routes should be minimised using measures to give them priority, such as direct routes to keep cycle times as short as possible, providing maximum signal green times and setting signals to respond quickly either when users pass over detection systems or when the control push button is pressed.
- 12.3.4 Table 12.1 suggests appropriate treatments for a stand-alone crossing of a two-way carriageway. It is a guide only, and individual locations should be assessed on a case by case basis. Reducing the speed or volume of traffic using the carriageway will enable a wider range of options for the crossing design to be considered.
- 12.3.5 Where there was no previous provision, suppressed demand may mean that crossing flows are higher than anticipated, especially in residential areas.
- 12.3.6 Crossings should be wide enough to cater for current demand, and projected increases in use. Catering for higher numbers at the design stage will avoid a route becoming compromised because dimensions were set at the minimum required. Once installed, it can be difficult to justify further expense if a crossing needs widening.
- 12.3.7 All crossings should be at least the width of the approach paths. Therefore, if the approach path is a cycle track, or shared use path 3.5m wide then the crossing should also provide a facility that is 3.5m wide. Formal crossings must never be less than 2.7m wide (3 x dropped kerb width).
- 12.3.8 The highway authority shall consult with the police and give public notice of a proposal to implement a new controlled crossing.
- 12.3.9 Crossing safety is enhanced by using kerb build-outs to reduce the width of the crossing, and/or by placing the crossing on a raised table to reduce vehicle speeds. Care should be taken to ensure that build-outs do not result in a pinch point for cyclists using the road.
- 12.3.10 The length of high friction (anti-skid) surfacing on the approaches to a controlled crossing should be determined based on the vehicle approach speeds. The surfacing should continue past the stop or give-way line for at least one metre.

12.4 Crossing types

- 12.4.1 The options for crossing roads shown in table 12.1 are relevant for:
- uncontrolled at-grade crossings (informal, buff tactile, pedestrian refuges)
 - unsignalised controlled crossings (Zebra or Parallel crossings)
 - traffic signals (Puffin or Ped X crossings, Toucan crossings, Pegasus crossings, signal controlled junctions)
 - grade-separation (bridges and subways)

12.4.2 At-grade crossings are relatively low cost and can usually be placed on or near to the desire line. Grade separated crossings provide a high-quality route over or under a road or other physical barrier, and are the safest solution for crossing busy roads with speed limits of 50mph and above.

12.4.3 The assessment of the need for, and design of, a pedestrian or cycle crossing shall refer to table 12.1 and Traffic Signs Manual chapter 6: Traffic Control, 2019.

Table 12.1 – Suitable crossings for speed/vehicle flows

Speed Limit	Total traffic flow to be crossed (AADT)	Maximum number of lanes to be crossed in one movement	Uncontrolled	Pedestrian Entry Treatment or Cycle Priority	Zebra or Parallel	Signal Control	Grade separated
≥ 60mph	Any	Any					
40 mph and 50 mph	> 10000	Any					
	6000 to 10000	2 or more					
	0-6000	2					
	0-10000	1					
≤ 30mph	> 8000	> 2					
	> 8000	2					
	4000-8000	2					
	0-4000	2					
	0-4000	1					

- Provision suitable for most people.
- Provision not suitable for all people and will exclude some potential users and/or have safety concerns.
- Provision suitable for few people and will exclude most potential users and/or have safety concerns.

Notes:

1. Table suggests appropriate treatments for a stand-alone crossing of a two-way carriageway. It is a guide only, and individual locations should be assessed on a case by case basis.
2. If the actual 85th percentile speed is more than 10% above the speed limit the next highest speed limit should be applied.
3. The recommended provision assumes that the peak hour motor traffic flow is no more than 10% of the 24 hour flow.

12.5 Priority junctions

12.5.1 The number of active journeys people will make will depend on how comprehensive the network of safe routes is and how well the routes connect with each other at junctions and crossings. If pedestrians and cyclists are required to stop and start their journey at every junction, unlike motor vehicles, then we may not see the change in behaviour that the act aims for. Providing priority junctions and crossings is key to that aim and highlights to other road users that walking and cycling are the priority form of transport in that area.

Figure 12.2 – Informal junction with no road markings. The uncertainty from the lack of defined priority has been found to be effective in requiring road users to slow down and engage with other users.



- 12.5.2 The rules for priority at major/minor arm junctions are indicated by the use of traffic signs and road markings. Priority is normally given to the dominant traffic flow. The dominant flow for pedestrians and cyclists may be different from that of motor traffic.
- 12.5.3 Four overriding principles underpin the design of priority junctions that are safe and suitable for cyclists using the carriageway:
- low speeds – on approaches and through the junction
 - good intervisibility
 - single lane approaches
 - designs that facilitate correct positioning and offer protection for right turns from the major arm
- 12.5.4 In several of the following design examples, reference is made to cyclists adopting the primary position. See glossary and chapter 9, 9.20.3 for an explanation of the primary position for cyclists.
- 12.5.5 When considering these options and any other significant changes to the layout of junctions, it is important to engage early on in the process with blind and partially sighted people to ensure that they can navigate the junction confidently and safely.

Unmarked informal junctions DE601

- 12.5.6 Junctions in urban areas, even on relatively busy routes, can be designed without defined priority as this feature is an effective method of requiring road users to slow down and engage with other road users. The application of these principles is becoming increasingly common and has been demonstrated in a range of scenarios without negatively impacting on traffic capacity or safety. Even complex four-arm junctions with peak period flows in excess of 2500 vehicles/hour can be suitable for this arrangement.

Examples include junctions in the centre of Coventry, in Poynton in Cheshire (figure 12.2) and in Fishergate in Preston.

12.5.7 Informal junctions can also use circular paving patterns to indicate roundabout-type priority without the use of road markings and signs. These informal roundabouts are discussed in 12.10.

12.5.8 This type of junction can work for cyclists on streets with 20mph speed limits as long as care is taken to ensure that the paths of motor vehicles through the junction are limited to one lane, so that cyclists can adopt a primary position.

Shared or separated pedestrian and cycle track crossing of side roads DE602 and DE603

12.5.9 Footways and cycle tracks should give priority to users crossing the side road on the major arm unless this is unsafe. Giving users priority over the side road enables them to continue without loss of momentum and contributes to the directness of a route.

12.5.10 Figure 12.3 shows a number of options for providing for cycle priority at side roads in urban areas. These have been classified by position of the cycle facility relative to the major road kerbline. Options also show how priority markings and the use of surfacing materials can combine to help achieve the desired behaviour:

- full set back – at least a car length (5m) from the kerbline
- partial set back – less than a car length from the kerbline
- no set back – at the kerbline

Figure 12.3 – Priority cycle track and side road crossing arrangement options

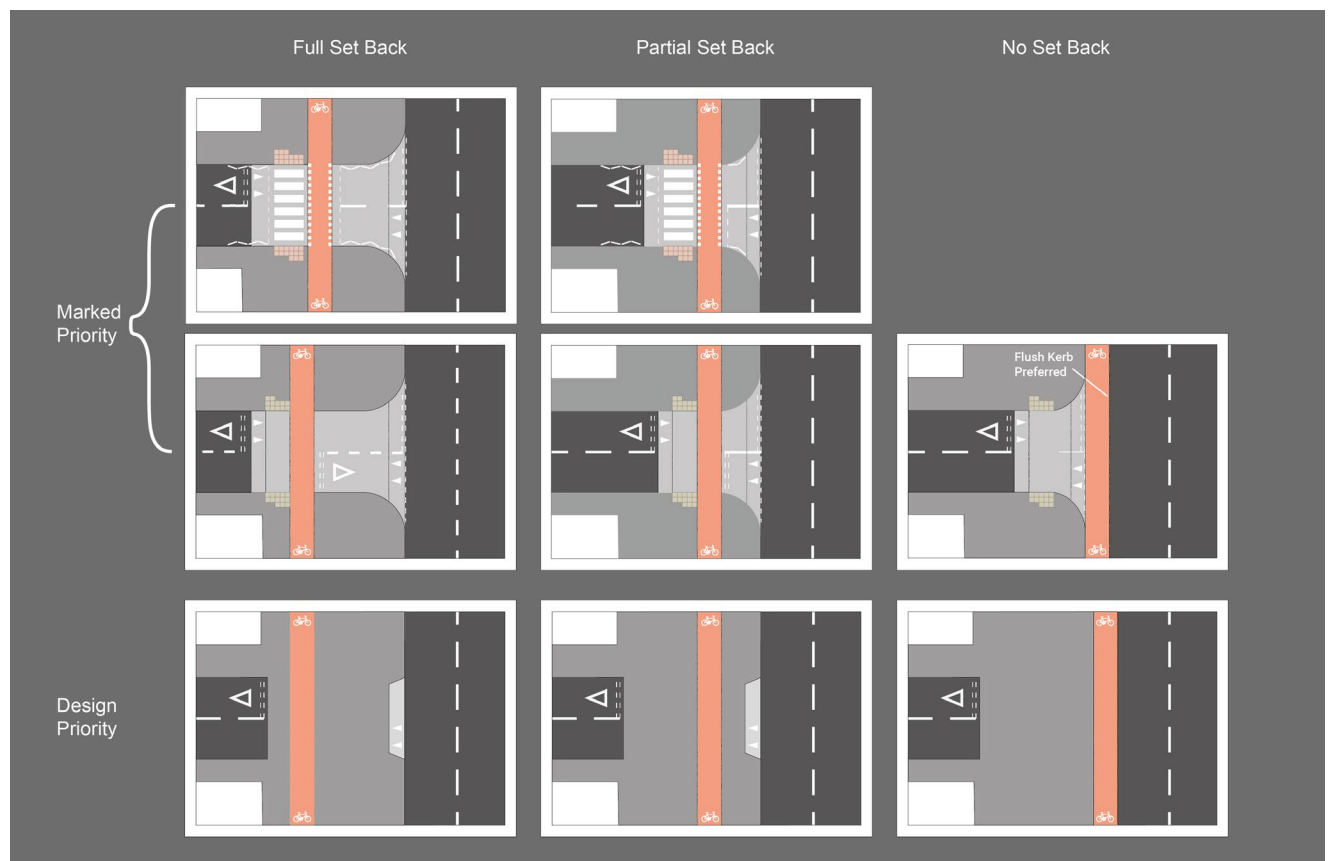

- 12.5.11 Factors to be considered when determining priority include: location, vehicle speed limit and actual speeds, visibility, number of pedestrian and cycle movements, number of vehicle turning movements, collision statistics and the feasibility of providing similar priority at nearby side road crossings (to provide greater consistency along a route).
- 12.5.12 Figure 12.3 also shows how priority road markings should be combined with layout and materials. In the top line priority is very prominently marked. The bottom arrangement shows continuation of the footway and cycle track surfacing across the junction mouth, and this reinforces the idea that turning traffic at the minor arm is crossing the active travel traffic along the major arm.
- 12.5.13 Side roads and accesses where vehicle speeds are less than 30mph and volume is less than 2000 vehicles per day will normally be suitable for priority crossings.
- 12.5.14 Where the cyclist is expected to give way, half-size give way markings on the cycle track will be necessary at road junctions (but not at private drives and field entrances).
- 12.5.15 In figure 12.4 the crossing is set back from the junction mouth by one car length and is on a flat top hump. This arrangement (DE602) helps to avoid the crossing being blocked by drivers waiting to turn out of the side road and offers more deceleration space for drivers turning in. Consideration of the lead in geometry is key and this alignment of the cycle track enables cyclists to proceed in a fairly straight line rather than have to make a sharp turn away from the mouth of the junction.

Figure 12.4 – Priority crossing of pedestrian and cycle track over side road, Ruthin



Side road entry treatments and blended junctions DE604 and DE605

- 12.5.16 In this arrangement the mouth of the side road junction is raised to footway level on a flat topped road hump. This makes it easier and safer for pedestrians to cross – particularly disabled people – by eliminating the height difference to the carriageway and slowing down turning traffic.

12.5.17 The speed reduction effect of side road entry treatments helps cycle safety by reducing the speed of turning traffic at the side road.

Figure 12.5 – Semi blended footway at side road with kerb line and tactiles retained, Clapham



12.5.18 At a 'blended' junction (bottom row of figure 12.3) there is no change in the footway material and no flush kerbs. Vehicles in this arrangement are effectively crossing a widened footway. Blind and partially sighted people have some concerns about this layout as they cannot easily detect that they are crossing a side road. Therefore local engagement with users should take place before considering a design of this type.

12.6 Uncontrolled crossings

12.6.1 An uncontrolled or informal crossing involves the provision of dropped or flush kerbs and tactile paving to enable people to cross to and from the carriageway. Blind and partially sighted people generally prefer signal-controlled crossings as they cannot easily tell whether traffic is approaching or how quickly.

12.6.2 Types of uncontrolled crossing include:

- mid link crossing
- crossing side road junctions
- informal crossing with a central median

12.6.3 Care should be taken over the siting of informal pedestrian crossing points in relation to vehicle crossovers so as not to cause confusion for blind and partially sighted people. Parking and loading restrictions may be needed to ensure visibility is adequate at the crossing.

Simple uncontrolled crossings DE606

- 12.6.4 Pedestrian and cycle traffic will generally be able to cross conveniently in a single movement with traffic volumes up to around 6000 vehicles per day, though the speed of vehicle traffic should be considered at the design stage.
- 12.6.5 Uncontrolled crossings can be highlighted with a different coloured surface or textured material such as imprint paving, and by changes in carriageway width such as build-outs. On low-speed streets such as 20mph zones the effect can be that drivers will often give way to pedestrians.
- 12.6.6 Uncontrolled crossings are usually provided across the minor arm at side road junctions for footways or shared surface cycle track/footways. Flush kerbs, perpendicular to the carriageway, should be inset into the side road approximately one metre beyond the end of the radii to ensure that blind people are not led into the main carriageway. Tighter radii will enable the set-back to be reduced so that pedestrians are not diverted from their desire line and will help reduce the speed of vehicles turning into the junction. Alternatively, a side road entry treatment may be appropriate to enable the crossing to be located closer to the pedestrian desire line – section 12.5.

Simple cycle priority crossing DE607

- 12.6.7 Where a cycle route crosses a relatively lightly trafficked slow speed urban street it should normally be given priority over the road. It should be clear to motorists that they must give way, and there must be sufficient visibility between the cycle track and carriageway.
- 12.6.8 A raised crossing is recommended to reduce traffic speeds locally and encourage drivers to give way and a coloured surface may be useful to highlight the presence of the crossing to motor traffic.

Figure 12.6 – Uncontrolled crossing with central refuge, Ruthin



Uncontrolled crossing with central refuge DE608

12.6.9 A refuge in the centre of the carriageway enables users to negotiate one lane of traffic at a time, which can be helpful on wider roads. Refuges are usually kerbed and fitted with bollards facing approaching traffic to provide protection. Flush kerbs and tactile paving should be provided on the footways and refuge in line with the crossing area.

12.6.10 A central refuge allows a cycle crossing to be undertaken in two easier movements, but the arrangement needs to avoid creating pinch points that can disadvantage cyclists using the carriageway, and the refuge must be wide enough to ensure that wheelchairs, mobility scooters, pushchair and cycles do not overhang into the carriageway.

Priority junction on opposite side of the road to the cycle track DE609

12.6.11 Where a two way cycle track is on the opposite side of the road to a priority junction a simple arrangement can be used where the cycle track access forms a fourth arm at the junction to create a cross roads arrangement.

Central median strips DE207

12.6.12 Central median strips provide space for pedestrians to wait while crossing a road in two stages using an area of different coloured or textured surfacing in the centre of a road. Central medians can encourage drivers to give priority to pedestrians at informal crossings.

12.6.13 This type of facility should be in addition to controlled crossings. Central medians can be kerbed, raised or flush with the carriageway surface – see figure 12.7 and because of these features can be more suitable than uncontrolled crossings for disabled or pedestrians with sight loss. As with other facilities it is important to engage with disabled people as early in the design process.

Figure 12.7 – Informal median strip, Poynton, Cheshire



12.7 Unsignalised controlled crossings

12.7.1 Unsignalised controlled crossings give pedestrians and cyclists priority over other traffic. They provide a more demand responsive and lower cost solution compared to signalised facilities.

Zebra crossings DE610

12.7.2 Zebra crossings are unsignalised crossings with transverse white bars painted onto the road surface and yellow flashing globes (belisha beacons) on black and white striped poles at each side of the crossing.

12.7.3 A driver or rider is required to stop at a zebra crossing when a pedestrian starts to cross. A blind or partially sighted person may not be able to detect whether a vehicle is going to stop to give way to them and therefore may be hesitant about using the crossing. People with learning disabilities and older people may also feel safer and more comfortable using signalised crossings.

12.7.4 Longer length zebra crossings may be divided into two parts by a central refuge or median, which will improve the quality of provision for slower pedestrians who will still have the priority to cross.

12.7.5 The signing and marking arrangements for controlled and uncontrolled crossings is prescribed in TSRGD. For zebra crossings the regulations require the installation of a minimum of two zig-zag markings on the approach to and exit from the crossing, to prohibit vehicles waiting or overtaking on the immediate approach.

12.7.6 The zig zag markings should be placed up to 2.0m from the kerblines, so that the zig zag markings can effectively form a continuation of the protected cycle lane, light separation or stepped track on the approach to a crossing.

12.7.7 TSRGD allows the zig-zag markings and yellow globes to be omitted at zebra crossings placed across cycle tracks – see figure 12.8. Humps may be placed in the cycle track to slow cyclists at or on the approach to the crossing.

Figure 12.8 – Zebra crossing of cycle track, Cardiff



Parallel crossing for pedestrians and cyclists DE611

- 12.7.8 This type of crossing provides a more demand responsive and lower cost solution to accommodate cycle and pedestrian crossing movements next to each other, compared to signalised facilities (see figure 12.8).
- 12.7.9 The crossing is similar to a zebra crossing, but with a separate cycle crossing indicated by TSRGD diagram 1055.3 'Elephants Footprint' markings and TSRGD diagram 1057 cycle symbols located between the zebra stripes and the give way line.
- 12.7.10 The parallel crossing is visually stronger than a cycle priority crossing (DE607) and drivers are more likely to respect the legal requirement to give way. It is therefore suitable for sites with higher traffic flows and speeds (table 12.1). It can also be used close to junctions, for example on the entries/exits to roundabouts.
- 12.7.11 As with zebra crossings, parallel pedestrian and cycle crossings may be divided into two parts by a central refuge or median, which will improve the quality of the crossing for both pedestrians and cyclists.

Figure 12.9 – Parallel crossing for pedestrians and cyclists, Cardiff



12.8 Signalised crossings away from junctions

Puffin crossings DE612 and DE613

- 12.8.1 Puffin crossings have nearside pedestrian red and green symbols located as part of or above the push button unit so that they can be seen at the same time as approaching traffic. Puffin crossings replace pelican crossings which are no longer authorised for new installations. Puffin crossings incorporate detection technology which allows cancellation of the pedestrian demand if a pedestrian crosses after pressing the button, but before the green man has activated. Additionally, the detectors are used to measure the speed at which pedestrians are crossing and can automatically adjust the time allowed to cross the road. A puffin crossing has the same light sequence as traffic signal junctions (i.e. no flashing amber road traffic signal/flashing green man, as was the case with Pelican crossings).

12.8.2 Touchless crossing control buttons are being trialled. Instead of pressing a button, users can wave their hand in front of the button with an additional benefit being to reduce exposure to viruses commonly found on push buttons.

Ped-X crossings DE612 and DE613

12.8.3 A Ped-X crossing is similar to a Puffin crossing in terms of signal sequence and detection, but uses farside pedestrian signal aspects. 'Countdown' displays which show the time in seconds to the end of the crossing period, can be used with Ped-X crossings. Ped-X crossings are more suited to busy locations where pedestrians may have difficulty seeing the nearside indicators due to crowding.

Toucan crossings DE612 and DE613

12.8.4 Toucan crossings are shared pedestrian and cycle crossings, and operate in a similar way to Puffin crossings, but with additional red and green cycle symbols. Toucan crossings may have either nearside or farside aspects and may also include countdown displays.

12.8.5 Consideration should be made for additional push buttons located back from the crossing position to aid those with mobility issues who need additional space or may not be able to dismount. Detection systems should be considered that identify approaching pedestrians and cyclists and can speed up the countdown timer and reduce waiting times.

12.9 Crossings at signal-controlled junctions

12.9.1 Pedestrian and cycle crossing facilities can be incorporated into signal controlled junctions. Crossings within signalised junctions may have nearside or far side aspects, countdown timers, and combined pedestrian and cycle signals.

12.9.2 Crossing facilities should normally be provided on all arms of a junction. The number of separate crossing stages that a pedestrian or cyclist has to use to cross should be kept to a minimum.

12.9.3 The crossing times should enable all pedestrians (particularly older people) to cross the road in an unhurried manner. Research by University College London has revealed that the walking speed of 1.2m/s, which is often used to set the length of pedestrian stages, is too fast for 85% of women and 76% of men aged 65 and over. The use of detectors and timing extensions can be used to accommodate slower pedestrians. Where signal stage timings are fixed, slower walking speeds should be considered if there are significant numbers of elderly or other people who may require longer to cross in the locality.

12.9.4 Straight ahead crossings are more convenient for pedestrians and cyclists and should be used wherever possible. Signalised crossings may be divided into discrete sections using refuges, with each part of the crossing operating on different stages of the signals for traffic capacity reasons. In the past, such crossings have often been staggered, with pedestrians having to cross each carriageway separately. There are an increasing number of examples of straight-ahead signalised crossings with wide central refuges that operate under separate stages. Staggered crossings involve additional delay and deviation from the desire line, particularly where the stagger is large.

- 12.9.5 Audible and tactile signals must be provided as these are essential for deaf, blind and partially sighted pedestrians. The volume of an audible signal can be manually adjusted to suit the environment. Where there are several crossings in proximity, standard audible signals may cause confusion. Bleep and sweep audible signals can be provided. These use a directional speaker and an adjustable volume to assist pedestrians in the vicinity of the crossing.
- 12.9.6 Tactile signals are rotating cones located on the underside of the push button unit. Rotating cones are always placed on the right-hand side of a crossing and must not be obscured by guard rail.

Cycle facilities at signal-controlled junctions

- 12.9.7 Signal-controlled junctions help cyclists and pedestrians during peak traffic periods by enabling them to make turning or crossing movements which would be difficult where the priority is left uncontrolled. When designing signalised junctions all movements and potential conflicts by all types of user must be analysed. This will help reduce journey times and improve safety for pedestrians and cyclists. Separation of movement for each user type may be deemed necessary on safety grounds but can add significant delays for all and so should not be the first choice for the design of signal-controlled crossings.
- 12.9.8 Minor timing changes to existing signal junction operation and lane markings can provide advantages to cyclists at some junctions without complex re-signalling works. Traffic modelling and simulation help determine how signal timing changes might operate and should be used during the design process.

Intergreen times

- 12.9.9 Cycle traffic coming through a signal-controlled junction at the end of the green phase may be travelling significantly slower than motor traffic, due to an uphill gradient for example. Intergreen times should be adjusted to ensure that cyclists can clear the junction before opposing traffic movement is started. Alternately an all-red phase can be triggered when a cyclist is detected.

Advanced Stop Lines (ASLs) DE614

- 12.9.10 An Advanced Stop Line (ASL) enables cyclists to take up the appropriate position in the 'reservoir', or waiting area between the two stop lines, ahead of general traffic, before the signals change to green. A cycle feeder lane is normally provided which will enable cyclists to pass queuing motor traffic on the approach to the stop line. ASLs are widely used and some local highway authorities now have a presumption to install ASLs at all signalled junctions.
- 12.9.11 ASLs will not resolve all problems for cyclists at traffic signals. ASLs provide benefit to cyclists on an approach when the traffic signals are on red. They have little value on approaches that are free-flowing, and/or approaches with multiple lanes, as cyclists will find it difficult to manoeuvre themselves into an offside lane to make a right turn. In these situations, alternative solutions should be considered.
- 12.9.12 Feeder lanes are usually provided on the nearside, but where there are high numbers of left turning vehicles crossing cyclists going ahead or right, central or offside feeder lanes between general traffic lanes should be considered.

12.9.13 'Gate' entries to ASLs are an option which allows legal entry to the reservoir where a lead-in lane cannot be achieved. However, a lead-in lane is preferable and gates represent a lower level of service for cyclists.

12.9.14 ASLs are not permitted at non-signalised junctions, or toucan/puffin crossings.

Cycle signals

12.9.15 An 'early start' signal phase for cyclists (also known as a 'cycle filter') in conjunction with an ASL enables cyclists to start ahead of other traffic (at the start of the green stage) to avoid potential conflict with traffic on the same arm (e.g. overtaking and turning left) or opposing traffic streams. Under this arrangement a green light for cyclists is illuminated for a few seconds at the start of the stage and is followed by the green signal for all traffic.

12.9.16 Including early start cycle signals in a junction design does not require any form of authorisation.

Figure 12.10 – Early start low level cycle specific light, Cardiff



Figure 12.11 – Separate cycle stage with high and low level cycle signals



12.9.17 Low level cycle signals may be used instead of, or as a repeater, to high level cycle advance signals. Low-level signals are easier for cyclists to see when at a stop line, though if there are several cyclists waiting at the lights, those to the right of the group cannot always see the low-level signal on the left hand side of the road. It is therefore important to also provide a far-side repeater at any junction with significant cycle flows.

12.9.18 A dedicated signal stage for cyclists can be used where a cycle-only arm joins a signalised junction. Cycle signals enable cycle and motor traffic movements to be separated in time. The signals can operate on demand, using detector loops or push buttons, or included within fixed staging.

12.9.19 Cycle-only signals are illustrated in figures 12.10 and 12.11 and can be useful, for example:

- hold the left turn (DE618) where cyclists using a nearside cycle track are given a dedicated green signal while the left turn across the track for general traffic is held on red
- where cyclists undertake a manoeuvre not permitted for other traffic, including pedestrians, such as travelling between the carriageway and a cycle track, or making a turn that is banned to other traffic

Permanent green cycle signal on bus gate

12.9.20 Traffic signals can be used at bus gates to provide queue relocation on the approach to a signalled junction. Several cities, including Cambridge, have incorporated a permanent green cycle aspect on the bus gate signal as there is no need to stop cyclists when other traffic has a green signal.

Figure 12.12 – Permanent green signal at bus gate



Diagonal pedestrian and cycle crossing stage during all red

12.9.21 A direct diagonal crossing at a signalled cross-roads may be preferable to directing cyclists or pedestrians across one arm at a time. Diagonal crossings will increase the overall crossing distance that a pedestrian or cyclist is required to make in one movement – therefore increasing the length of the red stage for other traffic – but it allows users to replace a “two stage” crossing movement with a “single stage”, reducing their journey times and therefore providing a desirable advantage to active travel modes. An example from Cardiff is shown in figure 12.13.

12.9.22 At junctions where pedestrians cross on an all red stage, it may also be feasible to install a diagonal crossing for cyclists without increasing the duration of the vehicle all-red stage, because cyclists are travelling more quickly and take less time to cross.

Figure 12.13 – Signalised diagonal pedestrian and cycle crossing, Cardiff



Cycle bypass at traffic signals DE615

12.9.23 Where there is space and relatively low levels of pedestrian use, a slip off in advance of a signalised junction, leading to a short section of cycle track, will enable cyclists to bypass a red signal (see figure 12.14 and 12.15).

12.9.24 This is commonly used:

- to turn left
- to continue straight ahead across the head of a T junction

Figure 12.14 – Ahead-only cycle bypass



Uncontrolled cycle crossing at signalised junction

12.9.25 Operational considerations may make it difficult to justify a separately controlled crossing for cyclists. In such cases it may be appropriate to consider an uncontrolled cycle crossing on an arm of the junction, with give way markings on the cycle track, as it approaches the junction. This also has the advantage that cyclists are not faced with a full red signal at a time when it is safe for them to proceed at caution.

Guiding cyclists through signalised junctions DE616

12.9.26 A cycle lane marked through a signalised junction provides a visible indication of route continuity and can increase the drivers' awareness of key cycle movements (see figure 12.16). They are commonly used in two situations:

- to indicate route continuity and protect space for cyclist desire lines on important cycle routes
- to mark out cyclist turning manoeuvres where these are different to the path of other vehicles

12.9.27 A road marking (TSRGD Diagram 1010, 1m line, 1m gap) should be used for the cycle lane within the junction. This is a more prominent marking than an advisory lane marking (TSRGD Diagram 1004).

12.9.28 Route markings through junctions will be subject to high levels of wear and will require maintenance.

12.9.29 Where it is necessary to indicate a less obvious cycle-only route for cyclists through the carriageway at a signalised junction it may be marked using "Elephants Footprints" markings (figure 12.17).

Figure 12.15 – Left slip bypass at signals



Figure 12.16 – Cycle lane through signalised junction



Figure 12.17 – Elephant footprint markings through junction



Two stage right turn at traffic signals DE617

12.9.30 When cyclists approach a junction on a nearside cycle track, advanced stop lines are impractical for turning right. A two-stage turn arrangement provides a right turn facility for cyclists at a signalised crossroads as an alternative to an ASL. It can be of particular benefit on a multi-lane approach where speed and volume of motor traffic makes the execution of a conventional right turn manoeuvre hazardous and unpleasant for cyclists, even with an ASL.

- 12.9.31 The cyclist wishing to turn right at a crossroads is able to pull-in to a waiting area in the exit mouth of the road on their left and wait there until that road has a green signal, at which point cyclists can complete their right turn (see figure 12.18).
- 12.9.32 Cyclists waiting to complete the right turn in advance of the stop line must be able to see a secondary signal on the far side of the junction in order to know when it is safe to proceed.
- 12.9.33 An 'early start' signal phase for cyclists using low level signals can be used to reduce conflict with left turning traffic.

Figure 12.18 – Two stage right turn signalised junction



Hold the left turn DE618

- 12.9.34 A short section of cycle track can be introduced on the approach to a signalised junction so that cyclists can be held while the traffic is turning left, and vice-versa the left turning traffic can be held while the cyclists are going ahead.

Protected junctions and cyclops junctions DE619

- 12.9.35 Where further protection above a hold-the-left-turn arrangement is required, a fully protected junction or cyclops can be considered. In this configuration cycle tracks either side of the carriageway feed into parallel pedestrian-cycle crossings (signalised) that operate during an all-red phase of the junction. Designers should appropriately consider the potential issue of the cycle track being crossed by pedestrians without a signalised control when considering this arrangement. In the cyclops variant that has been installed at locations in Greater Manchester, the pedestrian crossings are on the inside and the cycle tracks on the outside. This means that the uncontrolled pedestrian crossing of the cycle track is not directly in line with the controlled crossing of the carriageway.

Figure 12.19 – Four way signal controlled junction with pedestrian and cycle provision. Commonly referred to as a cyclops junction.



Trixi mirrors (blind spot mirrors)

12.9.36 Blind spot roadside mirrors are large convex mirrors installed at signalised junctions to enable drivers of large vehicles (buses and HGVs) to see down the nearside of their vehicles. They are intended to help address the significant proportion of serious casualties caused when large vehicles turning left cut across cyclists on their nearside. When retrofitting Trixi mirrors as a safety measure at an existing junction it is also worth considering whether guard rails can be removed as some fatal collisions have involved cyclists being crushed between the HGV and the guard rail.

Figure 12.20 – Trixi mirror on cycle superhighway 7, London



Cycle track alongside one-way carriageway at cross-roads DE620

12.9.37 Where a cycle track provides a two-way cycling facility alongside a one-way carriageway and intersects with a minor road where there is on-carriageway cycling, this signalised layout can be used which allows pedestrians to cross in a single controlled phase. The junction is fully signal controlled, with advanced stop lines for cyclists on the minor arms and signal control of the cycle track.

Parallel signalled controlled crossing DE621

12.9.38 When a two way cycle track swaps from one side of the road to the other then this signal controlled crossing arrangement enables pedestrian and cycle traffic to cross in the same stage, but with physical separation from each other.

Figure 12.21 - Parallel signal controlled crossing, Stockport



Two-way cycle track as larger cross-roads DE622

12.9.39 Where a two-way cycle track along a main road intersects with a minor road where there is on-carriageway cycling then this potential arrangement can be used to accommodate all movements. The junction is signal controlled, with advanced stop lines for cyclists on the minor arms and signal control of the cycle track. Pedestrian crossing areas are also signal controlled.

12.10 Roundabouts

12.10.1 Roundabouts offer vehicle capacity advantages over other forms of junction but can be hazardous for pedestrians and cyclists when designed in accordance with typical UK practice. Conventional roundabouts have entries and exits that are flared, with two or more lanes to increase vehicle capacity, and wide circulatory carriageways which are often unmarked. Deflection may be less than desirable because of the constraints on the space available. The relatively smooth path for motor vehicles can result in high traffic speeds through the junction and on the exit, particularly on large diameter roundabouts and should therefore be avoided for active travel routes.

12.10.2 Active travel routes can also avoid large roundabouts via grade separated facilities or a completely separate route away from the junction.

Provision at signalised roundabouts

12.10.3 Signalising larger roundabouts can assist pedestrians and cyclists by controlling conflicting traffic movements. Many of the measures described below can be applied at the individual arms around a signalised roundabout.

12.10.4 Many people will not feel comfortable using a large roundabout and are likely to prefer an off-carriageway route, directly through the centre or with signal control across the busier entries and exits, see figure 12.22.

Figure 12.22 – Signalised roundabout at Temple Quay, Bristol. Provision on and off carriageway



12.10.5 ASLs should normally be considered for each entry arm and if stacking space permits ASLs may also benefit cyclists on the circulatory carriageway. Providing an early start signal for cyclists may also be beneficial.

Provision at unsignalised roundabouts

12.10.6 For slow-moving cyclists, finding a safe position to occupy in a wide circulatory carriageway is difficult, and cyclists are at risk of not being noticed by drivers entering or leaving the junction.

12.10.7 Roundabouts with a dedicated left turn slip lane to increase vehicle capacity pose an additional hazard for cyclists, where the lane diverges and where a cyclist travelling straight ahead will leave the roundabout with fast moving traffic coming up on the nearside. They are not recommended for active travel routes wherever on-carriageway cycling can be expected.

12.10.8 Two ways to provide active travel infrastructure at roundabouts are:

- mini or compact roundabouts where traffic volume and speed is relatively low, and the lane width relatively narrow so that cyclists can occupy lane entries, exits and the circulatory carriageway in the primary/follow me position

- at larger roundabouts, where traffic volumes and speeds are higher (see table 12.1), provide an off-carriageway track around the junction, with parallel crossings or signal-controlled crossings of the entries and exits

12.10.9 The following design approaches will help make roundabouts safer for active travel:

- control vehicle speeds to around 20mph through the junction
- reduce the amount of space for motor traffic
- raise driver awareness of cyclists
- provide unobstructed passage for cyclists through or around the junction

12.10.10 Cycle lanes on the outside of the circulatory carriageway are not normally recommended, even on compact roundabouts, since cyclists using them are vulnerable to 'left hook' collisions with motor vehicles exiting the junction.

Mini roundabout DE623

12.10.11 A mini roundabout, where the external diameter is not greater than 15m, can be an alternative to a priority junction. The design of mini roundabouts is included in CD116 of the DMRB. By providing tighter radii, mini roundabouts help reduce vehicle speeds, and can be included in traffic calming schemes. Single lane approaches mean that cyclists and motor traffic pass through the roundabout in a single stream. The equal priority to all arms can help cyclists who might otherwise struggle to turn across moving traffic. Mini roundabouts can be a low-cost measure to improve junction capacity compared to traffic signals.

12.10.12 Three-arm, and quieter four-arm, roundabouts are relatively safe for cycling, but busier four arm, and combinations of double roundabouts may be uncomfortable and less safe from a cyclist's perspective and so should be avoided on active travel routes.

Compact (or "continental") roundabouts DE624

12.10.13 Compact (or continental style) roundabouts are included in CD116 of the DMRB and have tighter geometry that is more cycle friendly than conventional UK roundabouts. The geometry encourages lower vehicle speeds, enabling cyclists in the primary/follow me position to pass through the roundabout with other traffic. Compact roundabouts are therefore appropriate where cycle routes are within the carriageway.

12.10.14 Compact roundabouts have arms that are aligned in a radial pattern, with unflared, single lane, entries and exits, and a single lane circulatory carriageway. Deflection is greater, meaning that the roundabout can be an effective speed reducing feature. Compact roundabouts are suitable for speed limits up to 40mph. Compact roundabouts will usually have a lower traffic capacity than conventional roundabouts, but performance can still be assessed using standard traffic analysis tools such as Arcady.

Figure 12.23 – Compact roundabout, Waltham Forest, London



Conventional unsignalised roundabouts

12.10.15 Conventional geometry roundabouts (referred to in DMRB CD116 as Normal Roundabouts) with multi-lane flared approaches and wide circulatory carriageways are generally unsuitable for on-carriageway cycling and so no Design Element has been provided. Conventional roundabouts of this type should not feature on active travel routes unless suitable modifications are made.

12.10.16 The options to consider where a cycle route runs through a conventional roundabout are:

- redesign with compact geometry (see DE624)
- provide segregated cycle tracks with toucan, or parallel pedestrian/cycle crossings on each arm
- introduce signal controls to the roundabout, with appropriate cycle facilities
- replace roundabout with a signalised junction and cycle facilities

Figure 12.24 – Design for the conversion of existing conventional roundabout to compact roundabout, Cambridge

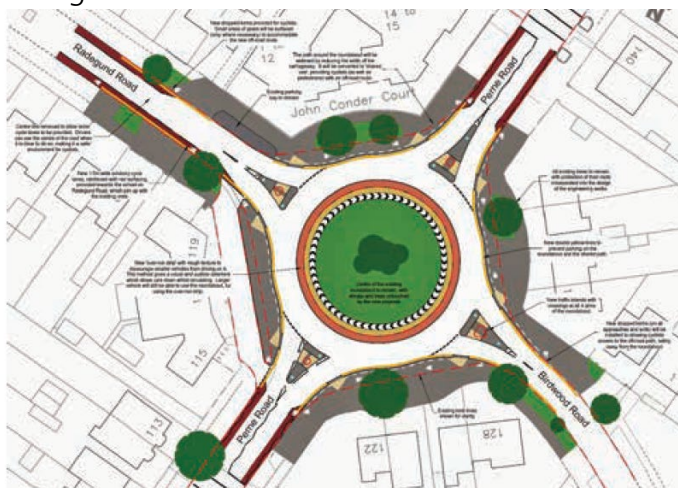

Dutch style roundabout DE625

12.10.17 The parallel zebra crossing facility introduced in TSRGD 2016 offers the opportunity to construct a 'Dutch Style' roundabout with full priority crossings for cyclists and pedestrians. It has the continental geometry with arms that are aligned in a radial pattern, with unflared, single lane entries and exits, and a single lane circulatory carriageway.

Figure 12.25 – Dutch style roundabout in Cambridge



Informal roundabouts at unmarked junctions

12.10.18 Some authorities have installed unmarked junctions that are designed to encourage drivers to adopt circulatory priority, but they are in fact uncontrolled junctions, with no formal road markings or signs. Some informal junctions are designed with circular paving patterns to operate this way.

12.10.19 These have been found to work well in capacity and road safety terms at relatively high flows, of up to around 2500 vehicles per hour. The use of circulatory patterns is appropriate where there is a high proportion of turning traffic, which would otherwise tend to give way to oncoming traffic in the centre of the unmarked space.

12.10.20 This type of junction can work well for cyclists as long as care is taken to ensure that vehicles only circulate in one traffic stream and travel slowly, so that cyclists can adopt a primary/follow me position when passing through the junction, in a similar way to the compact roundabout.

12.11 Grade separated crossings

12.11.1 Separating pedestrian and cycle movements vertically across links and at junctions, as well as at barriers such as rivers and railways, can provide a high level of service because users are removed from any conflict with motor vehicles and are not required to stop or give way. This approach is more likely to be suitable on larger roads with higher speeds.

Pedestrian and cycle bridges DE626

12.11.2 Well-designed bridges enable pedestrians and cyclists to cross major roads or other barriers without conflict or delay. New bridges can be designed as attractive features along a route and help to highlight how important active travel is as a mode of transport. Bridges are usually cheaper to install than new subways. Separation between pedestrians and cyclists is preferred in busy locations.

Figure 12.26 – Separated cycle track on Cardiff Bridge



12.11.3 Where the topography is favourable the need for approach ramps can be minimised. Ramp design should be considered at an early stage with approaches to the deck straight or nearly straight, as right-angled turns are difficult for cyclists to negotiate, as seen on the example from Conwy in figure 12.27. Additional stepped provision should also be considered for direct access where long ramps are required.

12.11.4 Good natural surveillance improves personal security and sloping sides are preferred to increase natural light and as well as improve security.

Figure 12.27 – Bridge with angled approaches, Conwy Morfa



12.11.5 Existing road bridges may have very high cycle flows and can be adapted to accommodate cycle tracks, as shown on the example from Cardiff in figure 12.26. Existing structures with narrow footways, restraining barriers or lower parapets should not be discounted, as it may be feasible to reduce the carriageway width or provide a cantilevered structure.

Subways and underpasses DE627

12.11.6 Well-designed underpasses can provide useful connections along footpaths or cycle tracks to cross under major roads, railways and watercourses. Where the topography is favourable the need for approach ramps can be minimised. Good natural surveillance is essential for personal security. Sometimes this option will involve the conversion of an existing pedestrian subway or an underpass which may be substandard, but still offers a safer solution than at-grade crossing.

Figure 12.28 – Pedestrian/cycle underpass



Departures / Arrivals

Destination	Time
London via The Bay	9:15
Paris	10:30
Madrid	2:15
Rome	3:45
Amsterdam via Ryan	5:00
Geneva	6:15
Barcelona via Ryan	7:30
Brussels	8:45
Frankfurt	10:00

Departures / Arrivals

Destination	Time
Amsterdam	9:15
London via Ryan	10:30
Paris	2:15
Madrid	3:45
Rome	5:00
Geneva	6:15
Barcelona via Ryan	7:30
Brussels	8:45
Frankfurt	10:00



Chapter 13: Integration with public transport and cycle hire

This chapter provides guidance on the integration of walking and cycling with public transport at stops, stations and interchanges. Details on cycle hire and park and cycling schemes are also provided in this chapter; demonstrating how these facilities provide active travel integration with public transport and therefore extend the number of people who can use active travel for everyday journeys.

Key areas for consideration include:

- connectivity with active travel routes at interchanges and public transport stops
- carriage of cycles on public transport
- public cycle hire

13.1 Introduction

- 13.1.1 Many journeys are short, and the entire trip could be made by walking and/or cycling. Longer journeys can combine public transport with active travel, thus reducing dependency on the private car. Walking or cycling to/from a public transport stop or interchange provides a reliable journey time and it is often the fastest option for short trips.
- 13.1.2 Well integrated walking and cycling links to/from public transport stops or interchanges – whether rail, bus, tram, taxi or ferry – provide efficient access to and from the interchange, improving the competitive advantage of active and public modes of transport. Integration therefore offers a beneficial effect of encouraging walking and cycling, increasing patronage (and thus viability) of public transport and potentially reducing local and longer-distance car traffic.
- 13.1.3 Active travel already accounts for a significant proportion of journeys to public transport stops, although there is scope to increase the share of both modes. Compared with walking, cycling significantly increases the catchment area (further still with the use of an e-cycle). Improving cycle access to interchanges is therefore a major opportunity to generate new trips or shift trips from car to sustainable modes.
- 13.1.4 In order for a multi-modal journey to be accessible to all via a combination of active and public transport modes, the entire door-to-door journey must be considered. The following table outlines these considerations; paragraph numbers are provided to show where the points are covered in further detail within this chapter.

Table 13.1 – Multi modal active travel journey considerations

Information about the service availability	The route from the starting point of a journey to the public transport stop/ interchange (13.2)	Provision at the stop/interchange (13.3)	Access on/off and within the service vehicle (13.6 and 13.7)	The route from the public transport stop/ interchange to the end point of a journey (13.2)
<ul style="list-style-type: none"> • Easily accessible timetables and service information in a variety of formats • Service information should be updated to cover any planned distribution (engineering works etc.) such as how wheelchairs or cycles are carried 	<ul style="list-style-type: none"> • Routes to/from the stop/interchange should meet the standards outlined within this guidance 	<ul style="list-style-type: none"> • Real time information and visual/audio announcements • Resting opportunities and toilet facilities at interchanges • Clear, unobstructed and direct routes through the interchange/hub • Clearly marked boarding locations for wheelchair/mobility scooter users • Secure cycle parking provision (see Chapter 14) and/or clearly marked boarding locations for users carrying cycles 	<ul style="list-style-type: none"> • Level access to/from the vehicle from the stop (with appropriate use of tactiles to aid users with visual impairments) • Suitable provision for wheelchair users/mobility scooter users in accordance with legal requirements • Suitable provision for cycle carriage • Regular bilingual on board audio and visual announcements and tactile signage • Training for user needs whilst boarding and travelling for vehicle operators/on board staff 	<ul style="list-style-type: none"> • Routes to/from the stop/interchange should be accessible to all pedestrians and cyclists (as outlined within the definitions under the Active Travel Act) • Wayfinding signage providing an orientation overview of the surrounding area, including appropriate tactile/ audio provision

13.2 Active travel to and from interchanges and public transport stops

- 13.2.1 Walking and cycling to stops, stations and interchanges require high quality routes that are well signposted, well lit, feel secure, and are maintained properly. Pedestrian routes should offer direct access from the surrounding area, with cycle routes to settlements/ trip attractors that are further afield. Public transport interchanges must be a high priority destination when planning the active travel network.
- 13.2.2 Interchanges are often busy environments. It is important therefore to provide safe access for users of active modes between services and other nearby facilities.
- 13.2.3 All bus stops should feel safe and comfortable. Stops for local services should be considered carefully so that they can be easily accessed on foot by people of all abilities. Their precise location will depend on a range of issues, such as the need to avoid noise nuisance, visibility and other road safety requirements, and the convenience of passing pedestrians and cyclists. The design of the space around existing and new bus stops should be considered as active travel routes are developed so that any potential conflict between users is minimised.

- 13.2.4 Footways may require local widening to accommodate waiting passengers while still allowing for pedestrian movement along the footway. Stops along main routes that are well connected with cycle infrastructure may benefit from dedicated cycle parking (see chapter 14). Where stops form part of separated or shared cycle routes, shelters, particularly those planned to include advertising hoardings, must be carefully placed so as to not restrict visibility of users likely to be stepping in front of/behind the stop. Recent examples of bus stops implemented in Wales have also incorporated greening elements. Further details of suitable bus stop infrastructure options can be found in chapter 11.

Figure 13.1 – Green roof on bus stop



- 13.2.5 Where new development is planned or when existing street layouts change, the opportunity should be taken to relocate public transport stops, or add new ones, aiming to reduce walking and cycling distances and ensure the stops are optimally located for local trip attractors.
- 13.2.6 The siting of new or relocated station/interchanges are reliant on a number of factors related to the railway network (e.g. train service patterns, track constraints) and the case for a new station (e.g. propensity for use, feasibility of build). The majority of the rail network in Wales (with the exception of sections of route along the Core Valley Lines that feed into Cardiff's Queen Street Station) are managed by Network Rail, and must follow UK Government processes for implementation. New or relocated stations are required to undergo a process known as the Governance for Railway Investment Projects (GRIP), which outlines eight distinct stages of scheme development.
- 13.2.7 Walking and cycling access to/from and within the station should be considered throughout these stages and the local authority should be involved in the development process from an early stage to plan routes accordingly in line with the duties of the act. Routes to/from the proposed station from key trip attractors should aim to meet the active travel route standards outlined within this guidance before the station becomes operational.

- 13.2.8 Under the Learner Travel Measure (Wales) 2008, local authorities are required to provide public transport to/from pupil's nearest school within a specified distance (outlined within the measure). This can often lead to lengthy and indirect routes for home-to-school transport. Provision of suitable active travel routes from home addresses to a nearby 'hub' pickup location can provide an opportunity to improve overall school bus service times. Mapping postcode data onto GIS systems can provide a quick way to establish where such hubs might be best placed.
- 13.2.9 Demand Responsive Transport (DRT) is currently in place in various local authority areas across Wales, for example via the Bwcabus and [Fflecsi services](#). Suitable pedestrian and cycle links to and from the boundaries of the operating areas could significantly increase the reach, and therefore patronage and viability, of such services.

Figure 13.2 – Demand responsive transport service



13.3 Active travel at interchanges and public transport stops

13.3.1 Interchanges between multiple forms of transport are important destinations in their own right. Key features that should be located at transport interchanges include:

- fully accessible with step free and clearly signed facilities for all users
- provision of seats and shelters
- passenger lifts should be capable of accommodating mobility aids and full size cycles, including those adapted for use by disabled people, and where these are single direction entrances, enough space to turn around
- left luggage, toilets and shops will make the prospect of waiting more comfortable and attractive

13.3.2 A code of practice ([Design Standards for Accessible Railway Stations](#)) applies to all passenger train and station operators in Great Britain.

Figure 13.3 – Transport for Wales train serving a newly built station



Cycle parking at interchanges/stops

- 13.3.3 Providing adequate space for cycle parking at bus, rail or ferry terminals is vital and should be given a high priority by authorities, working in partnership with the relevant operators and organisations managing the facilities.
- 13.3.4 Provision to store cycles securely at a stop/interchange must meet the needs of a range of different users, including those employed at the interchange, short term visitors, as well as long-stay parking for people cycling to or from the stop/interchange to board/alight another mode of transport. This may require a combination of provision throughout the interchange for different types of user (e.g. secure cycle parking both on the platform for long-stay users and outside the main entrance for short-term users).
- 13.3.5 The nature of public transport trips and the direction of travel should be considered. Outlying stops and stations that serve daily commuters travelling by bus or train to town or city centres are likely to have a demand for daytime parking. Town centre termini or interchanges may attract more overnight parking as cycles are used for the last-mile to/from the workplace. For commuter stations in particular, demand for cycle parking should be provided based on the future anticipated cycle mode share. Daily passenger numbers for every UK station are available from the Office of Rail Regulation (ORR) which can help indicate local demand and potential.
- 13.3.6 Secure cycle parking can also be provided in small quantities at suburban and rural bus stops, which will greatly increase their catchment area. Secure cycle parking can be provided at interchanges with good lighting, CCTV coverage, and the provision of specific equipment such as lockers, or secure entry cycle storage compounds.
- 13.3.7 At busier stations, secure cycle parking facilities with hire, repair, charging and retail facilities may be encouraged by local authorities working in partnership with commercial or voluntary organisations and rail operators. They may require subsidy, however, at least during the early stages of operation. The hub locations might also serve other purposes such as ticket sales, cycle freight consolidation, coffee shops and/or co-working/meeting spaces.

- 13.3.8 To support a continued modal shift to active modes, where improvement works are scheduled to interchanges/hubs, any effect on storage facilities should be considered and mitigated, for example, by provision of temporary alternatives if required.
- 13.3.9 Further details on recommended cycle parking options are described within Chapter 14.

13.4 Area wide cycle hire schemes

- 13.4.1 Cycle hire can take one of several forms. Area-wide cycle hire networks operating through docking stations are already in place in some Welsh locations, including Cardiff, Swansea and Vale of Glamorgan. Other examples of automated hire schemes in the UK include GPS tracked bikes that do not need to be returned to a fixed point. A further type of automated system is the Brompton Dock where users retrieve the bicycle from a high security locker, usually located at larger public transport interchanges. Another different model is where a business or social enterprise hires out bikes from a hub location during business hours.
- 13.4.2 Docked systems may be operated by a smartcard that is valid for other local transport, using an on-street payment terminal or smartphone system. The advantage for the operator is that the cycles must be returned to a dedicated parking bay. The disadvantage is that the pattern of cycle trips is often uneven, necessitating redistributing cycles around the system with a van, which adds to the operating costs, and can be awkward for users wishing to hire or return a bike when the nearest bays are either empty or full.

Figure 13.4 – Cycle storage – secure with fob entry



- 13.4.3 Potential users may wish to travel to destinations beyond the boundaries of the local authority area, where neighbouring local authorities are looking to implement hire systems, a partnership approach is therefore recommended.

- 13.4.4 Dockless cycle hire schemes operate using a mobile phone and online subscription, and are generally run by private sector operators. While they can be more convenient for users, the lack of dedicated parking space for the cycles can cause issues for other route users when cycles are parked inconsiderately, impacting particularly blind and partially sighted pedestrians. Although this type of operator generally provides more cycles in an area compared to a docked system, it is still necessary to redistribute and to recover cycles that have been abandoned outside the geo-fenced area. Many local authorities have experienced problems both with the operation and longer-term sustainability of dockless bike schemes and operators have been known to withdraw services at short notice.
- 13.4.5 E-cycles are now starting to be included as part of public cycle hire schemes which are ideal for towns in Wales where there are hills and services are dispersed over greater distances.

Cycle hire at public transport interchanges

- 13.4.6 Cycle hire provision at major hubs/interchanges, and in locations where tourism potential is greatest, can help to reduce onward private motor travel and support local accessibility. There are examples of where provision has been integrated between service operators, for example, figure 13.5 – Cardiff Bus mobile app showing hire cycle locations.

Figure 13.5 – Cardiff Bus mobile application showing cycle hire locations

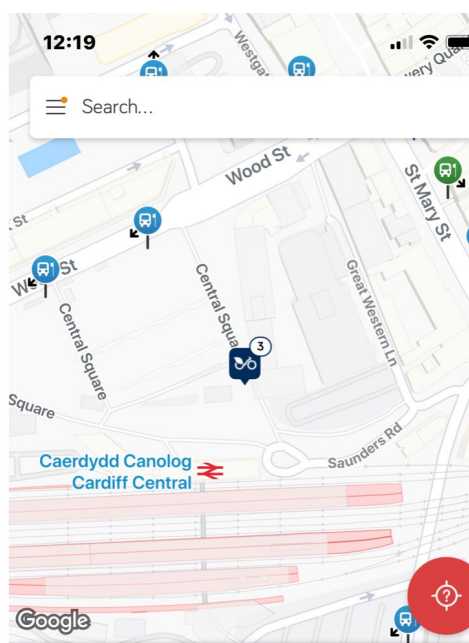

Cardiff Central Station, north side

Bikes here Drop-off space
3 **12/15**

To unlock a bike, download the **Nextbike** app

Figure 13.6 – Cycle hire scheme



13.5 Park and cycle

- 13.5.1 Park and cycle works in the same way as other park and ride sites (and may be co-located) but cycles take the place of the bus or rail journey stage. Users travel to the park and cycle area by car and park their vehicle, hire a cycle from a secure locker and cycle the rest of the way to their destination. Equipment such as clothing and helmets can be stored in the lockers. To maximise viability the pricing strategy has to allow for payment for parking, in addition to a fare on any associated bus or train service.
- 13.5.2 A park and cycle site has been operating at the University of Cambridge since 2001 – see www.admin.cam.ac.uk/offices/em/travel/cycle/park.html

13.6 Carriage of cycles on public transport

- 13.6.1 Some disabled people use cycles as mobility aids, and may need to take their cycle with them on the journey, or require cycle parking to be at the platform level so it is as close as possible to where they board the train. Operators are required to make reasonable provisions in either of these cases.
- 13.6.2 Some train operators provide flexible spaces on trains where priority is for wheelchair users but if not occupied by a wheelchair user the space can be available for the carriage of bicycles. Clear signage should indicate the priority usage for wheelchair users.
- 13.6.3 There are significant benefits for both users and operators in enabling public transport vehicles to accept cycles, and local authorities should encourage rail and bus operators to do so where feasible.
- 13.6.4 Cycle carrying provision on trains varies depending on the operating company and type of train being used on the route, with some operators requiring reservations,

restrictions at certain times of day for non-folding cycles and varying arrangements for storage of the cycles once on the train. It is recommended wherever possible that train operating companies permit the carriage of cycles and consider the needs of users with cycles (including adapted cycles and e-cycles) at the early design stages for the layout of new, or updates to existing, rolling stock. [The Rail Delivery group](#) provides best practice advice on accommodating for cycle carriage.

13.7 Carriage of cycles on buses

- 13.7.1 Carriage of non-folding cycles on buses is less common in the UK, though successful examples do exist, for example, in the Scottish Borders and Lake District. Examples of carriage options include accompanying trailer, or dedicated spaces for cycle storage within the vehicle and new low floor electric buses equipped with internal cycle racks are beginning to operate within the Conwy Valley. <https://www.bordersbuses.co.uk/bike-friendly-buses>
- 13.7.2 Bicycle racks directly attached to the front or rear of the passenger service vehicle are not recommended within the UK due to driver visibility and pedestrian safety implications (to the front) and security/visibility concerns for users loading/unloading to the rear.

Figure 13.7 – Cycle storage on a bus

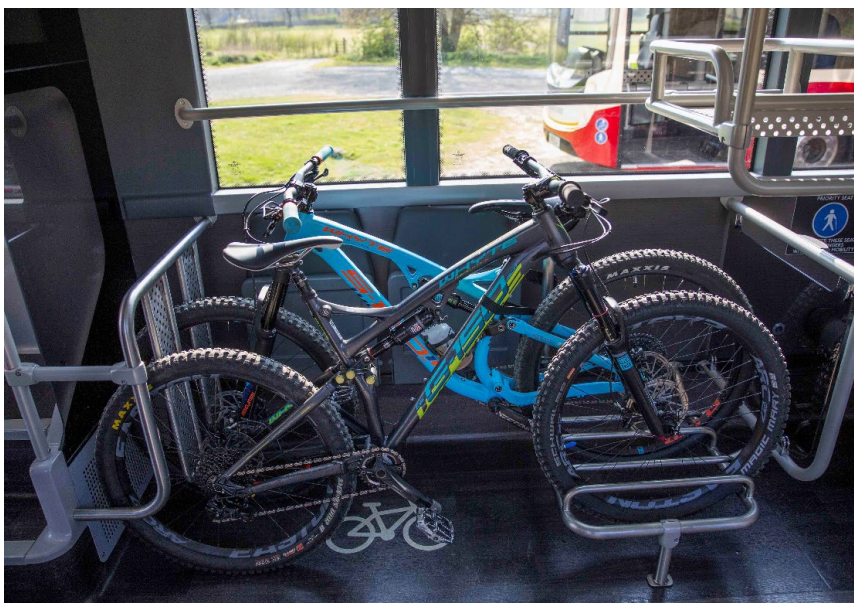

- 13.7.3 Even if cycle carriage is prohibited during the crowded peak hours it should be permitted at other times, public transport vehicles will typically be operating at peak loading for less than a quarter of the time. More efficient use of the vehicles can be obtained by encouraging a wider range of users in the off-peak, including those who wish to carry cycles with them.
- 13.7.4 Taxis form part of the public transport offer. Providing mountable racks for cycle carriage may provide a useful facility for some longer trips.

- 13.7.5 Dwell times of public transport vehicles are usually little affected by cycle carriage, but clear signs and announcements at interchanges and on the vehicles (see figure 13.8) will help users to know where to board with their cycles, avoiding inconvenience to other passengers and delay to services.
- 13.7.6 Where scheduled modes of travel are disrupted, for example, by planned engineering works, replacement provision should be provided for users who would normally be permitted to travel with equipment, for example, carriage of cycles on road vehicles replacing train services. Any advance notice of planned disruption should make the alternative provisions clear at the earliest opportunity during the period of disruption. Policies on replacement services vary between train operators, with further details available at staffed ticket offices and the [National Rail website](#).

Figure 13.8 – Train carriage with cycle storage clearly marked



Figure 13.9 – Train carriage cycle storage



Chapter 14: Related facilities

This chapter provides guidance on the design of important features to support active travel, including seating, landscaping, parking, e-cycle charging facilities, public toilets, washing facilities and direction signage. The second half of the chapter covers cycle parking, both at public transport interchanges and general specifications for cycle parking facilities.

The chapter relates to section 2(9) of the Active Travel Act. In determining whether anything constitutes related facilities for the purpose of the act a local authority must have regard to this guidance.

Key areas for consideration include:

- options and specifications for the various active travel related facilities
- how the provision of related facilities enhance the amenity value and can also help meet duties under the Environment Act
- local authorities must consult DfT's 'Inclusive Mobility' when drawing up specifications for related facilities to ensure they are appropriate for all users
- further information regarding signage and how detailed specifications can be sought from the Traffic Signs Manual.

14.1 Introduction

14.1.1 Section 2(8) of the Active Travel Act defines a range of features as related facilities for the purposes of the act including:

- facilities for shelter, resting or storage
- toilets or washing facilities
- signage
- other facilities, which are available for use by, or by any description of, walkers and cyclists using the active travel route

14.1.2 Related facilities must be included on the ATNMs and be added to the maps using DataMapWales. There are a number of existing related facilities on the maps and these should be audited and updated regularly as required so the information is kept up to date.

14.1.3 As noted previously, walking and cycling share certain similarities, though also have specific needs relevant to each mode which may differ between journey purposes. This also applies for related facilities.

- 14.1.4 Related facilities can contribute to making routes attractive, comfortable and coherent for users of active modes by the provision of items mentioned in section 14.1.1, as well as features such as litter bins, planting and landscaping. The latter can also contribute to the requirements of the Environment (Wales) Act and meeting statutory requirements for sustainable drainage (section 15.2) and enhancements to biodiversity.
- 14.1.5 Enhancing the attractiveness of active travel routes brings wider place making benefits. Involving the wider community not just walkers and cyclists in what related facilities would be welcome will help engender buy-in. Tools such as [Community Street Audits](#) can be useful for this purpose. Considering the impact of additional facilities to blind and partially sighted people must also be considered and the street audit toolkit should have an Equalities Impact Assessment element to it.

Figure 14.1 – Planters and cycle parking



Location and frequency

- 14.1.6 Seating should be provided at regular intervals along active travel routes. Seating is important for the activity and vibrancy of public spaces as well as providing an essential facility for disabled people. In busy pedestrian areas and key routes where older and disabled people are more likely to use them, resting places should be provided at intervals of around 50m as recommended in [Inclusive Mobility](#). Elsewhere a figure of 100m is appropriate as recommended in [Manual for Streets](#).
- 14.1.7 More seating should be considered where people congregate, such as public squares, local shopping parades and schools. The provision of well-placed seating encourages interactions within public spaces. Seating should ideally be placed where there is good natural surveillance and lighting to deter anti-social activity. Seating should allow for street activities to be viewed, though it must not hinder pedestrians or form an obstruction.

Figure 14.2 – Benches and trees in a public square



Design and guidance

- 14.1.8 Guidance on the design and layout of inclusive seating is given in Inclusive Mobility and BS 8300. In addition to standard height seating, lower seats are useful for people of small stature and children; and higher perches (700mm) against which people half lean and half sit are useful for some disabled people. All seat designs should enable people to easily sit and rise from them. Materials should be in keeping with the design of any adjacent street furniture and easy to maintain.
- 14.1.9 Seating should include spaces where wheelchair and mobility scooter users can sit alongside companions and be located so that when people are seated their feet are not in the pedestrian route. BS 8300 recommends the clear space for access to seating designated for disabled people should be 1.05 metres by 2.3 metres deep to allow for manoeuvring a wheelchair into a designated space from the adjacent footway at right angles.
- 14.1.10 Seating can be laid out in various ways:
- inward looking, to encourage conversation
 - outward looking, to see the views
 - in the centre of activities, for rest and chance meetings
 - at bus stops, for waiting (ideally covered)
 - in secluded corners, integral with planting

14.2 Public toilets

- 14.2.1 A lack of clean, accessible and safe toilets impacts everybody, but can disproportionately affect the most vulnerable of pedestrian users. Older people, parents and carers with young children, disabled people and people with chronic health problems all need easy access to suitably equipped public toilet facilities. Some people may feel unable or reluctant to leave their homes and visit areas where they fear they will not be able to find, or easily access, a public toilet.
- 14.2.2 Public toilets in town centres, parks and promenades help to encourage people who may need regular toilet access to take exercise and stay physically active. However, public toilets that are badly designed, badly maintained, and poorly located generate a sense of neglect.
- 14.2.3 Toilets should be no less available for disabled people than for non-disabled people. It is recommended that disabled toilets should be designated as unisex, not integrated with male and female toilets. The provision of unisex toilets allows use by disabled people accompanied by a carer or partner of the opposite sex. Facilities should include changing places that are equipped with benches and hoists to enable carers to assist severely disabled people.
- 14.2.4 Further guidance regarding toilet design and minimum specifications can be found in Inclusive Mobility and BS8300. Facilities may be provided in partnership with private sector businesses or public transport operators (but this will usually limit hours of opening). Further information is available at www.changing-places.org
- 14.2.5 Cycle parking provision designed for short stay activity should be provided close to the entrance of public toilet facilities (see 14.8 for further detail).

14.3 Washing and changing facilities

- 14.3.1 Washing and changing facilities are also helpful in enabling active travel, for example, the provision of showers at a longer-stay destinations, such as further education colleges and workplaces.
- 14.3.2 In many instances, it may not be possible to retrofit such facilities into destination buildings. In these cases, an area wide approach could provide a more deliverable solution, particularly for areas with high density of long-stay trip attractors. This can be combined with other facilities e.g. secure cycle parking to create a cycle hub that either has commercial opportunities or is a cost effective option for a cluster of buildings to fund together. See section 14.8.22 for further information about commercial cycle parking hubs.

Equipment storage

- 14.3.3 Appropriate storage facilities for clothing, helmets and comfortable shoes can also help in enabling utility journeys. This is most useful in long-stay destinations e.g. workplaces. Many people wear the same clothes for their active travel journey as at their destination, but lockers can be of benefit to people who wish to combine a utility journey with more high-intensity mode of active travel, such as run-commuters, or those who may occasionally need to store waterproof clothing/umbrellas and spare changes of clothing.
- 14.3.4 Publicly available storage facilities, such as left luggage can indirectly help enable use of active modes for utility journeys by removing the need to carry around heavy equipment/suitcases. Some users may risk having items stolen because it is too inconvenient to carry around with them at their destination, for example figure 14.3 cycling shoes and helmet left with a locked bicycle at a tourist destination.

Figure 14.3 – Lack of storage risks theft of equipment (shoes)



14.4 Planting and hard landscaping

- 14.4.1 Trees and planting improve the appearance of a street and provide a valuable barrier between active travellers and vehicles, enhancing route user safety and comfort. Planting can provide shade, shelter, privacy, spatial containment and separation. Vegetation can also be used to reduce vehicle speed by limiting forward visibility in traffic calming schemes (though should be considered against visibility requirements outlined in other sections of this guidance). Planting also helps mitigate any unavoidable impacts on biodiversity as outlined under a local authority's duties under the Environment (Wales) Act.
- 14.4.2 Vegetation can soften the urban street-scene, create visual and sensory interest, and improves the air quality and microclimate. It can also provide habitats for wildlife. The aromatic qualities or contrasting colours and textures of foliage improve amenity value and can also assist navigation for people with sight loss. Flowers and fruit trees add seasonal variety.

Figure 14.4 – Planting within a low traffic neighbourhood



Figure 14.5 – Planting and landscaping as part of a street re-design



14.4.3 Placement of new trees and shrubs sited adjacent to footways should be carefully selected so that their spread does not reduce pedestrian space below minimum dimensions for width and headroom and do not obstruct pedestrian sight lines. Low overhanging branches and leaves can be hazardous for blind or partially-sighted people. A minimum headroom of 2.1 metres is recommended.

Figure 14.6 - Poorly maintained tree blocking pavement



14.4.4 Space for planting can be integrated into layout and building designs, located on private land or buildings (in generous balconies, roof gardens, and walls) or public land intended for adoption, including the highway.

14.4.5 Hard landscaping using paving, textured surfaces, sculpture and architectural features also contributes to making streets more conducive to active travel. The design principles and user requirements set out in this guide apply to urban design as well as general highway design.

14.4.6 Conversion of underutilised carriageway space to features that include vegetative elements can also contribute towards the requirements of the Environment (Wales) Act, and sustainable drainage. Conversion can also achieve a more comfortable and attractive active travel route by integrating such features with cycle parking or as part of a seating area.

14.4.7 Parklets are becoming increasingly popular in the UK. These are mini green spaces – often repurposed from parallel parking spaces featuring soft landscaping e.g. planters and seating - made available for public use by businesses as a social seating area. During the Coronavirus pandemic many towns have found them useful in allowing catering businesses to continue operating despite social distancing restrictions.

Figure 14.7 – Parallel parking bay provision replaced with cycle parking and public seating areas



14.4.8 Such features can also act in support of other elements that are conducive to encouraging active travel, in line with the principles introduced within chapter 9, for example, improving the attractiveness by creating a more lively street environment and incorporating greening elements.

14.4.9 The long-term maintenance implications must be considered to prevent landscaping becoming an eyesore, and to prevent mature trees and street furniture from obstructing or damaging active travel routes (see figure 14.6). To ensure long-term viability planting will require:

- healthy growing conditions
- space to allow growth to maturity with minimal intervention or management
- species appropriate to a local sense of place and its intended function, and site conditions; (for example avoid plants where dropped leaves can become a slip hazard)
- suitable arrangements for long-term maintenance. In new developments these proposals should be agreed with the adopting local or highway authority, residents' or community association or management company

14.4.10 Vegetation that is planted with trench planting, irrigation pipes and urban tree soils will increase the chance of trees establishing themselves successfully, thereby minimising maintenance and replacement costs. The potential impact of plant roots on adjacent

buildings, footway construction and buried services must be considered. Planting should be capable of regeneration or easy renewal if vandalised and should be designed for minimal maintenance. Further advice on planting in streets and other hard paved areas is given in *Trees in Hard Landscapes: a Guide for Delivery*, published in 2014 by the [Trees & Design Action Group](#)

- 14.4.11 Containers can be used if trees and other shrubs cannot be planted directly into the ground. Their size and colour must accommodate the needs of the blind and partially sighted people and the position and spacing must be adequate for the anticipated flow of pedestrians. Regular cleansing is required to remove litter from planters, flower beds and shrubberies in streets.

14.5 Litter bins

- 14.5.1 Litter is a major concern for many people. 76% of Welsh adults when asked about the area they live in said they had seen litter or dog fouling on their local street ([Living Streets, 2012](#)).
- 14.5.2 Litter bins should be clearly identifiable and located where they are likely to be used. For example, a litter bin placed outside the entrance to a fast-food shop may be less effective than one placed 200 metres away where the food and packaging litter tend to be deposited.
- 14.5.3 Litter bins should offer sufficient capacity for the location. Local authorities and private owners responsible for their maintenance should ensure they are emptied frequently. Compactor bins, whilst more expensive to install, can reduce the frequency required for emptying. Materials choice needs to consider local conditions and ideally match the design themes of other street furniture. Plastic bins can suffer vandalism in some locations while metal bins corrode quickly in saline environments. Open topped bins are prone to having litter escape from them whilst closed top bins should be regularly cleaned to encourage usage.
- 14.5.4 Inclusive Mobility and BS8300 provide further guidance on the position, design, and height of bins in streets and other public areas.

14.6 Count displays

- 14.6.1 Automatic counters with a display panel can be installed alongside routes to help to promote a route and encourage users (as well as monitoring overall route usage – see chapter 16). The displays typically show the number of daily, weekly and cumulative total users per annum.

Figure 14.8 – Electronic cycle counter adjacent to cycle track



14.7 Signage

14.7.1 Signage is important for users of active modes for navigation as well as highlighting and promoting the presence of routes for other users. Well placed and clear bilingual signage will help users to find their way around an unfamiliar area or identify more direct routes between destinations. Signs should complement the surrounding environment and be planned at the route or network scale to ensure consistency.

14.7.2 Signage strategies should consider the following key principles:

- minimising signing – improve the clarity and safety of a route through improved design rather than extra signs
- minimising clutter – the use of signs which minimise street clutter through appropriate scale, good location and integration with existing street furniture
- sign coherence – the importance of coherent and consistent signage over a whole network and along a particular route, including connections to and from adjacent destinations
- maintenance – using good quality materials minimises the need and cost of future maintenance. This is particularly relevant for sign fixings, some of which can loosen and therefore require regular maintenance
- user value – good signage will enable users to locate themselves and the intended destination through use of strategic and local destination directions to include key facilities

14.7.3 Street name plates help with navigation and should be provided in a consistent style in each local authority area, mounted at or below 2.5m where practical. The plates should be provided at both ends of every street, except culs-de-sac, unless the cul-

de-sac extends onto a route for pedestrians and cyclists, in which case appropriate plates should be provided to show through access as these short cuts can be very advantageous for pedestrians and cyclists. On long streets where pedestrians are likely to join the street mid-way, street name plates provided at junctions with significant side roads can be very helpful for orientation, even more so if building numbers are included on these signs. On wide streets name plates on both sides is desirable.

Figure 14.9 – No through road with except cycles plate and directional signage (Except should be bilingual)



- 14.7.4 Signed active travel routes should always be as direct as possible but must avoid unsafe or poor quality infrastructure if this cannot be modified.
- 14.7.5 Care should be taken with the design of sign assemblies to reduce the risk of vandalism and sign rotation. Where fingerpost arrangements are proposed, purpose-built products are available which provide aesthetically pleasing non-rotatable signs. It is also important to ensure signs are located where they will be visible and not obscured by other signs or vegetation growth.
- 14.7.6 Pedestrian and cyclists have different wayfinding needs and signage is often best separated between the modes rather than combined. Specific advice for signage appropriate to each mode is provided below.

Mounting heights and positions

- 14.7.7 Where signs are erected above footways and cycle tracks, adequate clearance is required for pedestrians and cyclists. A minimum height of 2300mm for pedestrians and 2400mm for cyclists is recommended – see chapter 1 of the [Traffic Signs Manual](#). Signs on bollards are typically mounted at least 800mm high to ensure they can be easily seen, and signs on walls placed at a height of 1500mm.
- 14.7.8 Sign posts should be placed at least 500mm from the carriageway and cycle track edge, but no more than 1000mm from the route to ensure that they are visible to users. Where bollards are placed in cycle tracks a clear width of 1500mm is required for access by the full range of of wheelchairs and cycles.

Distance and time units

- 14.7.9 Distances must be expressed in miles, fractions of miles and yards as set out in The Traffic Signs Regulations and General Directions 2016 (TSRGD). Estimated journey times in minutes may be shown on cycle and pedestrian signs, particularly in dense urban areas or at transport interchanges. This can be a useful prompt for people who are new to the route and for example might hail a taxi if they weren't aware their destination is only a 7 minute walk away. Time and distance must not be shown on the same sign.
- 14.7.10 An average speed of 10mph provides a baseline for calculating cycle journey times but this needs to be modified to take account of any steep or long hills on a route. Local authorities should check actual journey times when developing a sign schedule. Beyond four to five miles, journey time estimates will become more inaccurate and only distances should be used.







Figure 14.10 – Destination/time sign example

Signage to moderate behaviour

- 14.7.11 As outlined in chapter 9, preference is usually to provide separate space for pedestrians and cyclists. However, there are many places where this is not practicable or desirable e.g. multi-user trails, promenades, canal and river towpaths and parks. In such areas it is important to remind cyclists and pedestrians to use the area with consideration for others according to the hierarchy of users. Table 14.1 highlights some signing options.

Table 14.1 – Examples of signage to moderate behaviour

	<p>Figure 14.11 – Advisory information sign placing pedestrians and cyclists on an equal footing. Use should be limited to key locations off-highway for maximum impact and to reduce sign clutter.</p>
	<p>Figure 14.12 – Advisory information sign clarifying hierarchy. This sign should not be the default on shared use routes and its use should be limited to key locations off-highway for maximum impact</p> <p>Can also be used either side of a bus stop if required</p>
	<p>Figure 14.13 – Advisory sign for a road where pedestrians, cyclists and motor vehicles should expect to share the same space</p>
	<p>Figure 14.14 – Advisory markings to highlight different user groups and promote considerate use</p>

14.7.12 Signage can also be used to moderate other road users behaviour to active travellers as shown in figures 14.15 below. This ‘close pass’ awareness sign is currently part of a trial in Gwynedd and Conwy counties with the plan to roll out this across Wales.

Figure 14.15 – Advisory Close Pass Sign



Figure 14.16 – Sign plate for close pass sign

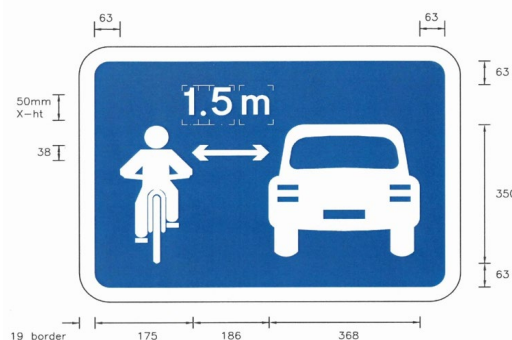

Pedestrian specific signage

14.7.13 Signage should be clear and give pedestrians who may not be familiar with the local area some indication of distance and/or time to local facilities. The ATNM review process includes a review of local facilities served by active travel routes and this should form the basis of a signage strategy.

14.7.14 Excessive signage contributes to the accumulation of street clutter. Most people will be aware of facilities close to their own home, but signs for pedestrians can be particularly useful where:

- people may not be aware of more direct walking routes away from the highway, leading them to use the car instead
- there are likely to be tourists or other visitors unfamiliar with a location such as town and city centres, hospitals, educational, historic and cultural attractions

14.7.15 Way finding aids, such as the on-street maps (see figures 14.17 and 14.18) are good examples of signs which fit well within the existing street environment. They are provided at points of arrival, such as outside public transport interchanges, and where routes converge in the city centres. Bilingual destination text is provided alongside pictorial graphics of the destination, for example a book to accompany the library text – this is potentially useful for those who cannot read English or Welsh. Positioning of such features must not impede clearance widths along active travel routes.

Figure 14.17 – Wayfinding scheme map Figure 14.18 – Wayfinding scheme signpost
(n.b. Welsh should be positioned to be read before the English)



- 14.7.16 In Wales, over 121,000 people are living with sight loss¹. Tactile versions of maps combined with audible information can be useful to those with sight loss and are increasingly provided through mobile and on-line media, though it must not be assumed that these provide an acceptable replacement for well designed built-environment interventions. Where appropriate, on-street signage should be accompanied with tactile embossed and/or braille markings.
- 14.7.17 Special paving slabs or plaques can be used to identify marked walking routes. Current examples in Wales mainly exist on longer-distance trails. Pavement markings and insets will only be useful to partially sighted people with sufficient residual vision. Generally the signs do not have enough distinctive texture or contrast to be identified underfoot or by blind people using a cane.
- 14.7.18 Further guidance regarding accessible signing can be found in Sign Design Guide – a guide to inclusive signing, published by the [Sign Design Society](#).

Cycle specific signage

- 14.7.19 Most cycle signs are placed in the highway and therefore subject to the Traffic Signs Regulations and General Directions (TSRGD) and accompanying volumes of the Traffic Signs Manual. Further information on signs for walking and cycling are included in TSRGD with further welsh guidance [here](#) and designers should always check the latest editions of TSRGD. The advice here complements that guidance by expanding on some signing issues particular to the design of cycle infrastructure.
- 14.7.20 Road signs and markings fall into three categories:
- regulatory – enforceable traffic management
 - warning and advisory – traffic management and markings that warn of hazards and to guide positioning
 - route guidance – location and direction signs
- 14.7.21 Signage for cycling may combine more than one of these functions. In Wales all signs with text must be bilingual with the Welsh language positioned so that it is read first. Examples of all approved highway signs can be found [here](#).
- 14.7.22 There are some cycling-specific signs and markings in each of the above categories. Cycle specific signing is useful to:
- make drivers aware of cycle lanes and tracks reserved for cyclists' use and assist enforcement
 - encourage lane discipline and safe positioning by drivers and cyclists
 - warn other road users of the likely presence of cyclists, particularly at crossings and junctions
 - make cyclists aware of rights of way where cycling is permitted or prohibited

¹ *Wales / Cymru - RNIB - See differently*

- enable users to follow recommended cycle routes
- promote cycling and raise its status

14.7.23 For non-prescribed signs (i.e. signs not included in TSRGD), authorisation is required. In Wales this authorisation is given by the Welsh Ministers.

14.7.24 Many signs are optional rather than mandatory. The majority of on-street cycle routes can be adequately catered for within the general traffic signing regime and by exemption to restrictions. It is useful to bear this in mind, as cycle infrastructure can be quite sign intensive and, if not carefully designed, can create unnecessary visual intrusion. Where appropriate, signs should be mounted on walls, existing posts or other street furniture to minimise the number of sign posts on the footway.

Route guidance, location, and direction signage

14.7.25 Route, location and direction signs create a usable network for cycling. It communicates to people where it is possible to travel and how much more direct these options can be than the alternative car or public transport journey. They are also essential to direct and reassure people who are not familiar with the area. Not all signing used for cycling needs to be specific – well implemented standard signing such as street names and traffic signs provide a foundation on which to make specific additions.

14.7.26 Cycle routes are usually distinguished by white on blue vertical signing with a cycle symbol. Cycle route signing and route confirmation should only be used where routes are direct and convenient and where the journey experience, under normal conditions, is reasonably good – audit tools in Appendix H should be used to establish the journey experience against acceptable levels.



Figure 14.19 – Diagram 967 - TSRGD - Route recommended for cyclists on carriageway

14.7.27 Along off-highway routes and back streets, general directional signs are unlikely to be present, and so cycle specific signs should address the requirements of direction signing as well as route confirmation. This can be done with signs or with road markings. On main road routes vertical signs should be used for direction signing, with a route symbol either on the sign or combined with lane markings to provide route confirmation.

14.7.28 On long sections of cycle route between junctions, route confirmation signs will let users know that they have not unintentionally left the route. The cycle route sign Diagram 967 on its own should not be used for this purpose as the cyclist could be on a different route from that desired. In urban areas repeater signs should be placed every 250 – 300m, or at key decision points (whichever is sooner). In more rural areas where route options are more limited, it may be suitable for repeater signs to be placed further apart (up to a mile).

In addition to marking the route itself, signs may be required to direct cyclists onto the route at intermediate locations. Signs may also be required to direct cyclists to destinations along the route or at the end. A specific locality, e.g. the local train station, should be used even if the cycle route itself does not go all the way there.



Figure 14.20 – Diagram 2601 (TSRGD) – Confirmation sign with arrow

14.7.29 Within each area a consistent set of destinations should be used, these will typically be divided into primary, local and supplementary destinations. Examples of these categories are given in table 14.2 and the following should be considered:

- where destinations are listed, closest destinations should be at the top of the sign, with more distant and strategic destinations below
- distances are given in full miles for any distance greater than 3 miles. Half and quarter fractions are used for distances under 3 miles (eg 1½ or 2¼)

Table 14.2 – Examples of primary, local & supplementary signs

Primary	Local	Supplementary	Examples
Flint	Northop Bagillt Greenfield	Public toilets; shopping centre; sports centres railway station; tourist attractions; named cycle route E.g. Taff Trail	
Newtown	Trehafren Vaynor Llanllwchaiarn		
Rhyl	Rhuddlan Dyserth Kinmel Bay		

- 14.7.30 Following 14.7.29 above the primary destinations in Wales are outlined in [Appendix C of LTN 1/94](#)
- 14.7.31 Where cross-border routes are proposed, the [Traffic Signs Manual \(chapter 2\)](#) provides an updated list of primary destinations for English settlements
- 14.7.32 There are various types of direction sign suitable for cyclists, and the choice depends on location and purpose. The main types are listed below. Note that detailed sign design requires specialist traffic engineer input, reference to the Traffic Signs Manual and normally the use of specialist computer software.

Table 14.3 – Examples of direction signs

Signage type	Usage/considerations	Example
Finger post	These are used at junctions. The sign itself points in the appropriate direction using a chevron arrow	
Advance signs	Used prior to the junction to give advance warning and enable initial manoeuvring to take place	
Stack signs	Useful where there are several different destinations, as a space efficient method to list above each other in tabular form. Can be used either in advance or at a junction	
Maps	Includes a pictorial representation (map) to clarify the navigation. Signs of this type are of value at complex junctions or where the route to be taken may be unclear i.e. left and then immediately right	

Information signage

- 14.7.33 Use of the CYCLISTS DISMOUNT sign should be avoided. On a well-designed facility the instruction for cyclists to dismount is very rarely appropriate and represents a discontinuity in the journey, which is highly disruptive. It should only be used in situations where it would be unsafe or impracticable for a cyclist to continue, or at the complete termination of a route, for example at a railway station forecourt. Even at these locations it should be borne in mind that some people who use their

cycle as mobility aid will be unable to dismount. There will seldom be justification for using a CYCLISTS DISMOUNT sign where a cycle route crosses or joins a carriageway. The alternative permitted variant 'CYCLISTS REJOIN CARRIAGEWAY' may be more appropriate (see figure 14.21).



Figure 14.21 – A positive instruction should be used where a sign is necessary to indicate the end of a route

14.7.34 Designers should design or modify schemes to ensure that its use of the CYCLIST DISMOUNT sign is avoided. Where these signs already exist it is recommended that authorities review locations and consider alternative provision to enable cyclists to proceed without dismounting, such as the use of the 'CYCLISTS REJOIN CARRIAGEWAY'. Where the sign's use appears unavoidable, designers should be able to defend their decision as to why it cannot be avoided.



Figure 14.22 – Advisory information should be used where a sign is necessary to indicate a restriction such as low headroom

14.7.35 The END OF ROUTE sign to TSRGD diagram 965, and the END marking to TSRGD diagram 1058, are not mandatory, and should be used sparingly. As with CYCLISTS REJOIN CARRIAGEWAY, where their use appears unavoidable, designers should be able to defend their decision and why it cannot be avoided. When deciding whether to use them, consideration should be given to the purpose they are meant to serve. If the end of the route is obvious, they are redundant. If the cycle route cedes priority on ending, GIVE WAY signing should be used instead.

14.8 Cycle parking

14.8.1 Good quality secure cycle parking helps encourage cycling and can be provided quickly without significant change to other infrastructure or a lengthy approvals process. Secure cycle parking at either end of a trip has a significant influence on cycle use. The risk (or

direct experience) of cycle theft and vandalism will undermine investment made to the cycle network by deterring people from cycling.

- 14.8.2 A key principle of making cycling an attractive mode of transport compared to the private car is competitive advantage. Well located cycle parking conveniently close to the destination or interchange plays a significant role in minimising journey times. A simple test is that the walking distance to the destination or interchange from the cycle parking should be closer and more convenient than from car parking provision.
- 14.8.3 As with active travel routes, cycle parking should be:
- safe – secure for the cycle and users should feel safe from the risk of personal crime
 - direct – near to the cycle route and/or adjacent to the final destination
 - coherent – well-connected to routes and buildings, well-signed and easy to find
 - attractive – of good quality design and well-maintained
 - comfortable – easy to use and accessible to all
- 14.8.4 The design should also be inclusive with proper consideration of the variety of needs of potential users. Leaving a larger gap at the end of a row of Sheffield stands (see below) and offsetting further from the wall will allow larger bikes and trikes to make use. Appropriate signs should be installed to designate these spaces in areas where there are likely to be accessible cycles needing to be parked. Seating close to the cycle parking can be helpful as cyclists frequently need to adjust luggage and store away bike lights just after they have locked their bike, so benches provide a useful resting place.
- 14.8.5 The appropriate quantity and type of cycle parking differs between locations, though parking should be provided at the following types of destination:
- places of residence
 - interchanges with other modes of transport
 - short stay destinations such as shops, cafes and public toilets
 - long stay destinations such as workplaces and educational establishments
- 14.8.6 Cyclists generally want to park as close to their destination as possible, and short-stay cycle parking should normally be sited very near to the final destination or main entrance to buildings. Where this is not the case, cyclists are likely to 'fly park' (cycles parked in locations that are not within the designated parking areas) such as locking a bike to railings and lamp columns. However when leaving their bike for longer periods cyclists will trade some convenience for the enhanced security of a locked or staffed enclosure.
- 14.8.7 Figure 14.23 gives guidance on the relationship between proximity, security, duration of stay, shelter and additional services that might be appropriate for each setting. In locations where there may be multiple types of user, e.g. a train station with a mix of long distance travellers and local commuters, it may be suitable to provide a number of cycle parking options.

Figure 14.23 – Relationship between cycle parking type and security facilities

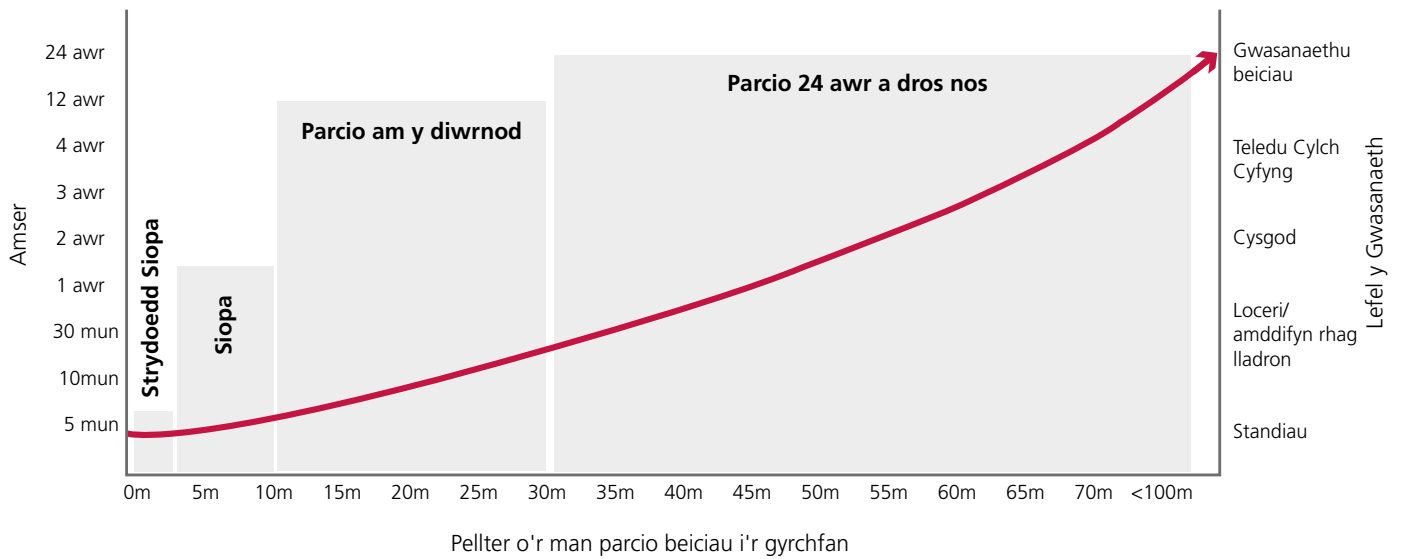

Quantity

14.8.8 There should be adequate cycle parking to meet demand including spare capacity to allow for growth in cycling. The quantity will be dependent on the location and nature of provision. Where cycle parking already exists, regular counts of parked cycles will give an indication of any excess demand or current spare capacity. Counts should be undertaken in good weather at a range of times during the day.

14.8.9 Addressing where there is fly parking is a good start to a cycle parking strategy. Where 'fly parked' cycles are found, this will give an indication that the existing parking provision is:

- insufficient to meet demand
- not secure enough to provide confidence to users
- too far from the entrance to the destination

14.8.10 It is good practice for local authorities to provide local planning guidance on cycle parking requirements for new developments. Table 14.4 suggests appropriate minimum cycle parking levels for typical land uses.

Table 14.4 – Cycle parking quantities for new development

Land use type	Sub category	Short stay requirement (obvious, easily accessed and close to destination)	Long stay requirement (secure and ideally covered)
All	Parking for adapted cycles for disabled people	1 space minimum. 10% (up to 50 spaces) 5% of total capacity (over 50 spaces) co-located with disabled car parking	1 space minimum. 10% (up to 50 spaces) 5% of total capacity (over 50 spaces) co-located with disabled car parking
Retail	Small (<200m ²)	1 per 100m ²	1 per 100m ²
	Medium (200-1,000m ²)	1 per 200m ²	1 per 200m ²
	>1,000m ²	1 per 250m ²	1 per 500m ²
Employment	Office/finance (A2/B1)	1 per 1000m ²	1 per 200m ²
	Industrial/warehousing (B2/B8)	1 per 1000m ²	1 per 500m ²
Leisure and institutions	Leisure centres, assembly halls, hospitals and	Greatest of 1 per 50m ² or 1 per 30 seats/capacity	1 per 5 employees
	Educational institutions		Separate provision for staff and students. Based on travel plan mode share targets, minimum: Staff: 1 per 20 staff Students: 1 per 10 students
Residential	All except sheltered/elderly housing or nursing homes		1 per bedroom
	Sheltered/elderly housing/nursing homes	0.05 per residential unit	0.05 per bedroom
Public transport interchange	Standard stop	Upon own merit	
	Major interchange	1 per 200 daily users	

14.8.11 Where current occupancy is close to the capacity of available spaces, it is likely that there is suppressed demand. Capacity should be increased by at least 20%.

Cycle parking options

14.8.12 Different types of cycle parking offer different characteristics in terms of their ease of use, weather protection, security and space requirements. Table 14.5 sets out a range of cycle parking types and gives guidance on where these might be appropriate. In general, well designed simple cycle parking design (such as the Sheffield Stand) will allow both the frame and wheels to be secured, and can be arranged to accommodate non-standard cycles (specifically adapted stands should be clearly marked to prioritise users of adapted cycles who may not be able to use the standard layout, alongside adequate provision of standard design facilities).

14.8.13 Locating cycle parking correctly so that users can securely lock both frame and wheels to the parking stand is an important factor in deterring theft.

Table 14.5 – Range of cycle parking equipment types

Type	Retail on-street	Retail off-street	Employment	Leisure, schools	Residential	Public transport stops/station	Notes
Sheffield stand	✓	✓	✓	✓	✓	✓	Flexible solution provides secure locking for a variety of cycles. Reasonably priced and available in a variety of finishes, multiple formats and shape variations. Well-spaced stands allow two cycles to be parked at each stand. May be combined with baseplates to form a “toast-rack”
Street stands	✓	✓	✗	✗	✗	✗	More compact but less stable/locking points than a Sheffield stand. Suit a variety of cycle types
Vertical stand	✗	✗	✓	✗	✓	✗	Compact space requirement but often requires user to lift cycle. May be incompatible with certain cycle types. Requires secure locking point
Two-tier stand	✗	✓	✓	✗	✓	✓	Suitable to locations where very high levels of cycle parking are required in confined spaces. Some users may find lifting cycle to upper tier difficult

Type	Retail on-street	Retail off-street	Employment	Leisure, schools	Residential	Public transport stops/station	Notes
Lockers/cages	✗	✗	✓		✓	✓	High security but time-consuming to use and with high-space requirement. Best suited to long-stay parking. Likely to require maintenance
Wheel stands	✓	✓	✗	✓	✗	✗	Compact footprint but should include facility to stabilise and lock the cycle frame to the stand. Can be incompatible with some cycles/wheels. Stands that support cycles only by the wheel can cause damage to cycles and should be avoided
Wall fittings	✓	✓	✗	✓	✗	✗	More compact but less stable/locking points than a Sheffield stand. Suit a variety of cycle types
Street furniture	✓	✓	✗	✗	✗	✗	Compact space requirement but often requires user to lift cycle. May be incompatible with certain cycle types. Requires secure locking point

14.8.14 Whilst not covered under the definition of active travel within the act, use of children’s scooters to and from school is a popular mode of travel, and consideration should be given to safe and secure storage of these alongside cycles.

Figure 14.24 – Example of scooter parking rack at a school



Cycle parking layout

14.8.15 The following factors should be considered when locating cycle parking:

- Security – cycle parking must allow users to secure their cycle with a variety of lock types
- lighting – essential for personal security and for parking after dark
- weather protection – careful consideration of surroundings can provide beneficial coverage, for example roof overhangs, rather than having to install specific shelters
Dry cycle storage is important for commuters and overnight parking
- obstruction – Parked cycles should not obstruct routes used by pedestrians and can be a hazard to blind and partially sighted people. Visual aids such as high visibility markings and tapping rails on the outer stands in a row or contrasting colour/texture paving may be used to delineate cycle parking areas
- potential to integrate with existing street furniture, signing or planting
- located on level ground or, if this cannot be achieved, perpendicular to the slope to avoid cycles rolling down the slope
- located in obvious, clean, maintained and overlooked areas to deter vandalism/theft, and to make users feel safe and welcome
- located where a safe, comfortable, coherent, attractive and direct route is available to/from the facility

14.8.16 Cycle parking stands should be large enough to accommodate the dimensions of a typical adult size cycle, as given in chapter 9. Some of the stands should be designed to accommodate larger cycles and trikes or cycles constructed for carrying freight or children where they can be expected to park frequently – these should be clearly marked and alongside adequate provision for standard cycles. In all cases the location of cycle parking should ensure that parked cycles will not obstruct nearby walking and cycling routes.

14.8.17 Cycle stands placed too close to a wall or fence will inhibit two-point locking and consequently the bike may be more likely to fall over. Sheffield stands should be placed at least 600mm from any wall or kerb (approximately 1000mm to the centre of the stand) to allow for the overhang of the wheels. Cycle stands placed too close together will reduce capacity by preventing the usual practice of one Sheffield stand being used for two cycles (one each side); the recommended gap between stands should be 1200mm, with a minimum of 1000mm, see figure 14.25.

14.8.18 Where cycle stands are placed immediately adjacent to a carriageway there is a risk to cyclists stopping and wheeling bikes into and out of the stand. Designers should consider the speed and volume of local traffic when assessing this risk. The position of other existing or proposed street furniture, such as bus shelters or benches, should be taken into account. Stands should not be placed where they obstruct the flow of pedestrian traffic or reduce available footway width for pedestrians beyond the recommended minimum.

Table 14.6 – Space required for cycle parking

Situation	Dimensions	Area per cycle
Stands on street	1.8m x 0.5m	1m ²
Within building – minimum	1.8m x 0.5m spaces plus 1.8m aisle	1.35m ²
Within building – desirable	2.0m x 0.75m spaces plus 3.0m aisle	2-3m ²

Figure 14.25 – Recommended layouts and dimensions for Sheffield stands – perpendicular and echelon

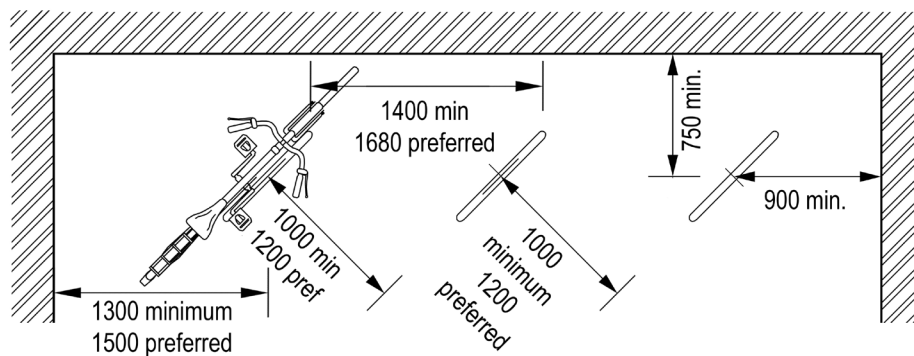
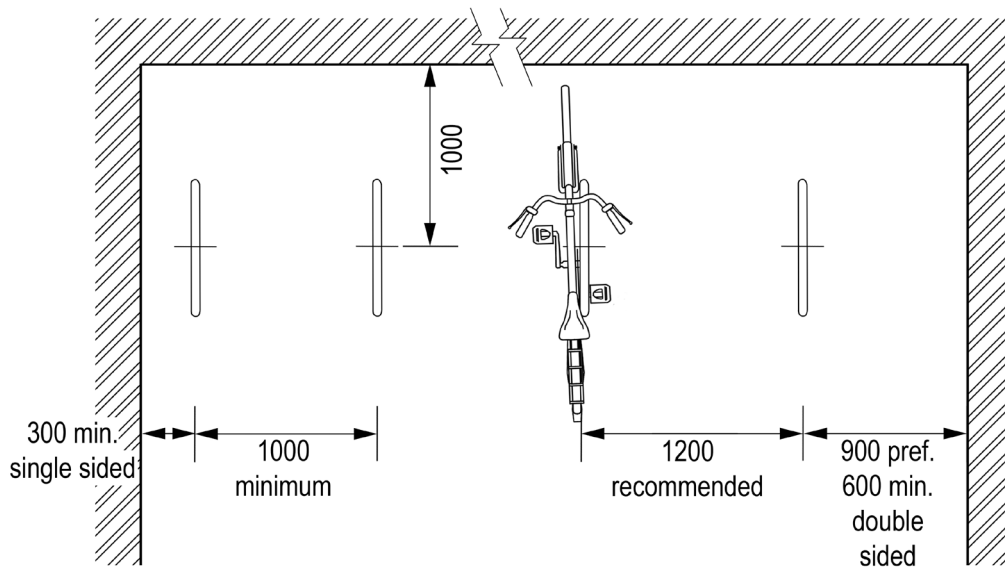

14.8.19 In on-street locations where space for cycle parking is limited, for instance constrained or busy footways, consideration should be given to the placing of cycle parking stands on the carriageway, or on build-outs between parking bays. This may require the reallocation of existing kerbside car parking. Such provision should include a tapping rail on the end stands for long-cane users to detect them.

Figure 14.26 – Good practice for siting cycle parking

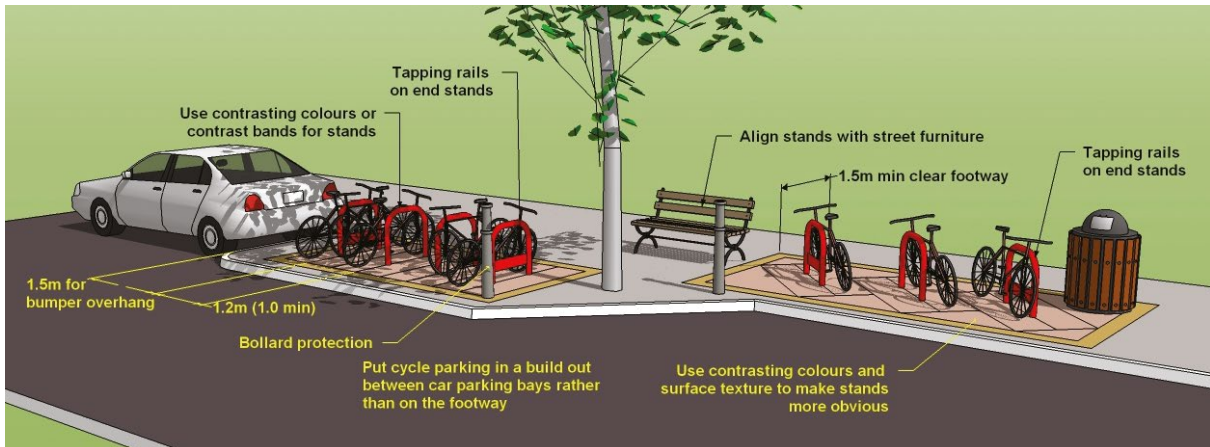

Figure 14.27 – Car parking cycle stand



14.8.20 Around eight cycles can be accommodated in the same space taken by one car parking space. Care should be taken to minimise the risk of vehicles striking cycle stands or parked cycles – the stands will usually need to be protected through the construction of build-out extensions into existing carriageway space.

Residential cycle parking

14.8.21 Storage of cycles is an important consideration at both ends of a journey. Some housing types do not provide for suitable cycle storage facilities, for example flats which require stair climbs or high-density housing, such as houses of multiple occupancy (generally popular with students and young professionals). Unsuitable storage of cycles may lead to blocking of internal corridors or stairwells, inhibiting evacuation or rescue in event of emergency. Secure communal cycle parking, such as relocation of a parking bay to accommodate a cycle locker can provide a solution to this and be a much more efficient use of roadscape by serving a greater number of people's transport needs.

Figure 14.28 – On street secure residential cycle parking



Commercial cycle parks

14.8.22 In urban locations with high demand for regular long-stay parking such as transport interchanges and city centres it may be appropriate to provide paid for cycle parking facilities. Such facilities typically offer high numbers of secure and dry cycle parking spaces on a commercial basis, and may also lease spaces to nearby residential and office blocks.

14.8.23 The commercial viability of such facilities is likely to be related to the availability of other cycle parking locally and the additional services offered such as:

- cycle hire
- bicycle retail and repair
- gymnasium
- coffee shop/café/bar
- newsagent/grocery
- showers, changing rooms and lockers

Security

14.8.24 No facility can ever be 100% proofed against theft. The overall security of the cycle parking is affected by:

- quality of the user's lock and how it is used to secure the cycle
- location of the cycle parking relative to other uses of the street/building
- site of the cycle parking within a property
- levels of visibility and illumination
- quality of design and construction of the cycle parking stand/mechanism
- security of the installation of the cycle parking stand/mechanism into the ground
- whether it is fully open to the public or only to selected users
- quality of locking mechanism and other construction

- 14.8.25 Cycle thieves target places where they can easily find items that can be quickly sold and where they are least likely to be detected. Passive surveillance and CCTV can help to deter crime and identify perpetrators, but in practice thieves are rarely noticed or challenged.
- 14.8.26 To improve security cycle parking equipment should be either embedded in concrete or bolted down. Where the legs of tubular cycle stands are embedded into concrete the addition of a tie bar beneath the ground can help ensure that the stand cannot easily be loosened and pulled out if the surrounding terrain is unstable or constraints mean that the manufacturer’s recommended minimum construction depth cannot be achieved.
- 14.8.27 Tamper-proof fixings must be used where stands and other types of parking are bolted down, and to secure component parts of cycle parking fixtures. Hexagonal nuts and bolts, allen/hex keys or torx/star bolts and crosshead bolts or screws should be avoided as these can all be undone with commonly available spanners.
- 14.8.28 Secured by Design (SDB) is an official police security initiative that provides accreditation against a set of standards for cycle parking hardware. Detailed guidance is on their [website](#).
- 14.8.29 Guidance produced on behalf of the Bicycle Association ‘[Standards for Public Cycle Parking](#)’ includes the following measures for ensuring good security of cycle parking at railway stations. It is also useful as a guide for other locations. Within this document, a series of tests are described to determine the suitability of cycle parking provision, as outlined in table 14.7.

Table 14.7 – Public cycle parking facility test

Test	Action
1	Does the equipment permit locking of both wheels and the frame of a standard cycle to a securely fixed element of the stand using two D Locks? If yes pass
2	Does the equipment pass independent testing to Secured by Design Level 2? If yes pass
3	Does the equipment provide support to the standard bicycle so that it remains upright without the use of a kick stand or similar? If yes pass
4	Does the equipment require the user to lift the cycle more than 50cm unaided to get the front or rear wheel or the whole cycle into the equipment? If yes fail
5	Does the user need to apply a force of more than 105 Newtons in the course of the parking operation? (Assume cycle weight of 15kg) If yes fail
6	Is the equipment capable of safe use by a heavy cycle (30kg?) If yes pass
7	Is use of the equipment likely to damage the bike by scratching or putting force onto a mudguard. If yes fail
8	Does the design have sharp edges or corners that could potentially injure people? If yes fail
9	Can the equipment be vandalised or disassembled using common hand tools (spanners, screwdrivers, torx, allen keys)? If yes fail
10	Equipment passes external testing to Secured by Design Level 2 (or Level 1 if within a secured compound). If yes, pass

- 14.8.30 Short stay and long stay parking present different risks of theft. The risk level also alters overnight when the number of passers-by is much reduced. It is important to think about how and when the cycle parking will be used when considering appropriate layers of security.
- 14.8.31 Where cycle parking is in busy open areas, users may be more relaxed about security and use a less secure lock or attach the cycle to insecure street furniture. Thieves target cycles that can be easily removed with simple hand tools, and then use the stolen cycle to get-away unnoticed. Promotional materials and warnings displayed around the cycle parking facility can help remind users to lock their cycle securely.
- 14.8.32 In long stay cycle parks, and where cycles are parked overnight, thieves may have the opportunity to work undisturbed for longer, using battery powered tools as well as hand tools. Limiting access to registered keyholders therefore provides an additional level of security.
- 14.8.33 Useful insights into methods of cycle theft have been gathered by police and journalists interviewing former cycle thieves over the years to understand their behaviours. These insights are useful when planning new cycle storage facilities to minimise opportunistic theft. Examples can be seen at:
- <https://road.cc/content/feature/interview-inside-mind-bike-thief-159190>
 - <https://www.stolenride.co.uk/thieves-most-common-targets/>
 - <https://www.stolenride.co.uk/former-bike-thief-london-interview/>

Maintenance and monitoring

- 14.8.34 Future maintenance of facilities should be considered and responsibilities determined at the design stage of installing new cycle parking. Poorly maintained features are unlikely to instil confidence in cyclists that the provision is a secure place for storage. Finishes such as galvanised steel can help to reduce maintenance costs, though this should be considered against the context of the area and likely users. More prominent colours would be more appropriate where a high number of occasional and touring cyclists pass through.
- 14.8.35 A system should be in place to identify and remove abandoned cycles. For public facilities this can be incorporated into maintenance schedules by recording and identifying cycles that have not moved from the stand for a long period. For controlled access facilities the terms and conditions of use can specify a maximum period after which unused cycles will be removed.
- 14.8.36 Where cycle parking has already been provided, regular counts can help to establish patterns of use and trends over time. Once the cycle parking occupancy regularly breaches 90% this can trigger the provision of additional capacity. When counting parked cycles and occupancy of stands, it is also important to note how many cycles are parked informally (i.e. away from cycle parking stands) to get a true picture of the total demand. In some cases informal parking may also occur if the formal parking stands are located in an insecure or inconvenient location, and may therefore be indicative of the preferred location.

14.9 Public cycle maintenance facilities

- 14.9.1 Provision of bike maintenance facilities made available for public use, such as air pumps and basic tools are becoming more common. Locating these along well-used routes or at cycle parking locations and hubs can help to install confidence for potential cyclists and is also a positive reinforcement that the local authority is encouraging cycling.
- 14.9.2 Such features should be placed in clear view to raise awareness and ideally in areas well overlooked to damage or theft. They should be provided within well-lit areas to ensure users can clearly identify tools and any associated instructions. Potential users may be unfamiliar with the design of some tools e.g. an on street pump may look considerably different to a personal pump, so they should be clearly labelled – including that provision is free.
- 14.9.3 To further deter theft publicly available tools should be tethered. It is therefore important that enough space provided around such features to ensure the tools are accessible to be used on a variety of cycle types. Space requirements outlined within chapter 9 can also be applied in this instance.

Figure 14.29 – Public cycle maintenance facility at Colwyn Bay



14.10 E-cycle charging facilities

- 14.10.1 The rise in popularity of e-cycles in recent years, and their potential to cover greater distances than standard cycles and so increase the number of people and miles being cycled, merits investment of charging facilities for e-cycles. A few examples are already in place across Wales.

Figure 14.30 – Public e-cycle charging facility, Aberystwyth



14.10.2 E-cycles are currently considerably more expensive than standard cycles. As a valuable asset owners of e-cycles may be particularly cautious about the risk of theft, and therefore may be keen to use more secure, longer-stay parking facilities. Some users may decide to remove the battery pack whilst using standard cycle parking to render the cycle inoperable. Nearby lockers can therefore be useful but it is also common for users to take the battery pack with them and charge it remotely. Not all e-cycles have removable batteries however, so providing charging points at long term cycle parking locations is likely to be in increasing demand.

14.10.3 The provision of charging facilities are best placed in cycle hubs, or longer-stay cycle parking destinations, e.g. residential areas, schools or workplaces. Publicly available charging facilities should be clearly marked and ideally provided adjacent to suitable provision for non-electric cycles to deter parking of pedal cycles blocking charging facilities. Ideally, they should be placed in locations convenient to destinations where people can spend time whilst awaiting the e-cycle to charge, for example libraries and shopping centres or in a town centre location.

Figure 14.31 – E-cycle public hire docking station



TrawsCymru™
Cysylltu pobl a chymunedau • Connecting people and communities

Sganiwch y cod QR
I gael mwy o wybodaeth
Scan the QR code for more information

The advertisement features a central image of a hand holding a smartphone that is scanning a QR code. Above this image are two columns of icons and text. The left column is titled 'Planner Journey' and includes a map of Wales, a network diagram, and a QR code. The right column is titled 'Gwybodaeth Ardal' and includes a directional sign icon and a QR code. Below the smartphone image is a button that says 'SCAN NOW'.

Logo of the Welsh Government (Llywodraeth Cymru / Welsh Government) and the European Union.



Chapter 15: Construction, maintenance and management of active travel routes including streetworks

This chapter provides guidance on the construction, maintenance and management of any pedestrian or cycle facility and associated matters. It also provides guidance on the specific considerations for pedestrians and cyclists where streetworks and construction sites affect their space within the highway.

Key areas for consideration include:

- surfacing options for active travel routes
- sustainable drainage systems
- access controls
- management of active travel routes at Streetworks

15.1 Construction

- 15.1.1 Close attention must be paid to construction and maintenance standards to ensure that routes used by pedestrians and cyclists are safe and comfortable for all, as well as being, aesthetically acceptable, easy to maintain and durable.
- 15.1.2 It is important to consider the full life costs and benefits when specifying materials and construction methods. Certain options may require increased capital expenditure at the outset but result in lower maintenance and management costs. It is only by considering street planning, street design and highway management that user needs can best be met.

Surfacing requirements

- 15.1.3 The typical choice for carriageways is a bituminous surface. Different products are available, each with their own properties, but the main choice is usually between Hot Rolled Asphalt (HRA) and Thin Surface Course System (TSCS).
- 15.1.4 All active travel routes should be machine-laid rather than hand-laid, which is less regular. As noted in chapter 9, a smooth surface with negative texture significantly reduces the effort needed to push or cycle, adding to comfort. For this reason, TSCS is recommended as the preferred surfacing for active travel routes.

Figure 15.1 – Negative/positive texture of path surfaces

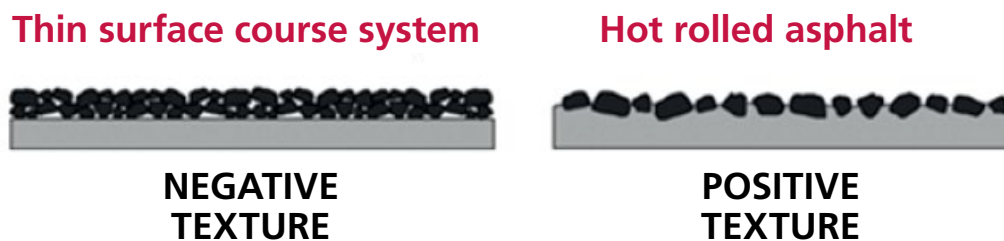

- 15.1.5 Modifications to the surface may be required to incorporate cycle lanes, advanced stop lines, or traffic speed control measures (traffic calming). Dimensional tolerances should follow normal highway standards.
- 15.1.6 Where kerb re-alignment is needed any new carriageway construction should be to normal highway standards unless there is kerb segregation of the cycle lane, when a lighter construction should be used, although surface quality should still be to highway standards.

Coloured surfacing

- 15.1.7 As noted in chapter 11, black bituminous surfacing in conjunction with cycle logos and appropriate lane markings is satisfactory in most circumstances and colour should be used sparingly. Extensive use of coloured surfacing is not recommended as it increases maintenance costs. Poorly maintained coloured surfacing can also pose an additional hazard for cyclists.

Footway construction

- 15.1.8 Footway construction should be of sufficient depth to withstand the loads likely to be imposed on it.
- 15.1.9 Consideration should be given to the likelihood of accidental or intentional overrun of a footway by heavy vehicles and the strength/thickness increased accordingly. The construction at vehicle crossovers will need to be thicker than the adjacent lengths of footway. Cracking or rutting of surfaces due to overloading can be unsightly, create trip hazards and/or drainage problems. The construction specification for footways, footpaths and cycle tracks is contained in DMRB CD239.

Footpath construction

- 15.1.10 Where a footpath is constructed away from the highway, consideration should be given at the design stage to the practicalities of constructing the path and access arrangements for construction vehicles.
- 15.1.11 Access points to some paths can be several hundred metres away and may require material to be moved by dumper truck. This might be satisfactory for moving sub-base materials but keeping tarmac hot enough to lay properly may be a concern. Additional access points may need to be constructed, and the path may need to be strong enough to carry heavy plant associated with the works.
- 15.1.12 Where a footpath provides regular access for maintenance vehicles e.g. adjacent to waterways or rail lines, the surfacing and construction of the path needs to reflect this.

15.1.13 It may also be necessary to thicken sub base layers, or use geotextile materials where ground conditions are poor. Where paths use land that is contaminated it is best to avoid excavating, use an alternative alignment or raise the path levels if the area cannot be avoided.

Cycle track construction

15.1.14 One of the common reasons why some cyclists use the carriageway in preference to a roadside cycle track is that the ride quality of the carriageway is often of a higher standard and therefore more comfortable. The surface quality of the cycle track should be at least as good as that of the adjacent road and should always be machine laid.

15.1.15 Among the most important considerations in choosing an appropriate surface material are cost (and variation by colour), durability and skid resistance. Polished stone value (PSV) gives a measure of skid resistance. A PSV of 55 is normally acceptable for road skid resistance. Table 15.1 shows, indicatively, a comparison of different surface materials and treatments according to these criteria.

15.1.16 The preferred surface is machine laid bituminous material, although bound or unbound aggregate, concrete or stone flags or paving blocks are sometimes used. Unbound aggregate surfaces are generally unsuitable in an urban/urban fringe environment. They cause excessive dust in dry weather and can be susceptible to ponding and become muddy in wet weather, leading to rapid deterioration.

15.1.17 Paving blocks, concrete or stone flags will provide a more aesthetically attractive finish and are more suited to high quality public realm areas. The surface finish must have adequate skid resistance, the joints will be less comfortable to cycle on and paving can be more problematic to maintain if slabs become loose.

15.1.18 There may be local sensitivities around surfacing of paths with black bituminous material in areas of high heritage value or green spaces. These should be considered and addressed as part of the consultation and the use of appropriate materials should always be paramount. There are a range of options for appropriate materials which should all be assessed against the aims of the overall project at the early planning and design stage.

Table 15.1 – Surface treatment for cycle routes

Surface Material	Life (years)	Skid resistance (PSV)
6mm asphalt concrete	20	60+
Coloured TSCS, 30-50mm thick	20	55+
Block paving	20	55
Brick paving	20	-
Concrete paving flags	10	-
Tactile paving	10	-
York stone flags	20	-
Granite paving flags	20	-
Thermoplastic High-Friction Surfacing	4-6	70+

Surface Material	Life (years)	Skid resistance (PSV)
Resin High-Friction Surfacing	8-10	70+
Cycle Track Veneer (thermoplastic slurry)	5	55+
Cycle Lane Veneer (polymer binder)	10	55+
Slurry Seal (poor colour and life)	5	55
Surface Dressing — Granite Stone (bituminous binder)	20	60+
Surface Dressing — Granite Stone (clear binder colour enhance)	20	60+
Surface Dressing — Pea Shingle Stone	20	50



Tactile paving



15.1.19 Tactile paving is provided on walking routes to assist blind and partially sighted people in moving around an area and on separated shared-use routes to navigate safely, preventing people from walking into the cycle track inadvertently. Types of tactile paving and their typical uses are listed in table 15.2. The most common form of tactile paving provided in association with walking routes is blister tactile paving at road crossings.

15.1.20 Guidance on the provision of tactile paving is set out in the DfT’s publication ‘[Guidance on the Use of Tactile Paving Surfaces](#)’ and reference should be made to that document when specifying tactile paving.

15.1.21 Current national guidance covers simple layouts but does not give detail for the wide variety of layouts that are encountered. For non-standard layouts designers need to apply the principles contained in the DfT’s guidance and consult with local groups who represent blind and partially sighted people during the design process.

Table 15.2 – Tactile paving

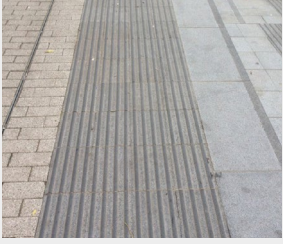

Type of tactile paving	Typical usage	Typical example
Blister (red coloured)	Signalised pedestrian crossing facilities, including zebra and toucan crossings	
Blister (buff coloured)	Uncontrolled pedestrian crossing facilities	

Type of tactile paving	Typical usage	Typical example
Corduroy	Where a footway joins a shared use path, top and bottom of steps or other hazard	
Ladder/tramline	Start, end and repeater indication of separated footway/cycleway (ladder on footway side and tramline on cycleway side)	

Edgings, kerbs and verges

- 15.1.22 Active travel routes may require some form of edge restraint to maintain their structural integrity. Where a route is not adjacent to a wall or building an edging strip is used. Edgings are generally formed from precast concrete units. Any edge treatment will increase the overall cost – pre-cast concrete kerbing roughly doubles the cost of a path. Timber edging may be adequate in rural areas away from the highway, and where the ground is stable.
- 15.1.23 In many locations away from the highway an alternative to kerb edgings is to construct the sub-base and binder course 300mm wider than the path, providing a 150mm shoulder on either side to support the path.
- 15.1.24 A kerb is normally used to delineate the carriageway and footway of a road. The kerb offers a degree of protection to pedestrians and can assist blind or partially-sighted pedestrians to identify the edge of the footway.
- 15.1.25 In lower speed streets and access-only streets it may be appropriate to omit the kerb. In these areas the impact of not providing a kerb on blind or partially-sighted users should be considered with appropriate use of tactile paving (including guidance paving for navigation), or a low kerb upstand be retained. Kerb heights should be as set out in table 15.3.

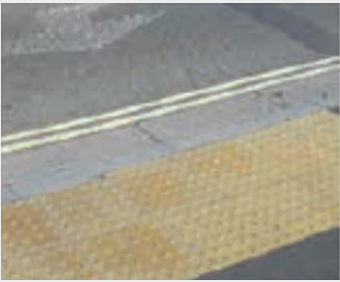
Table 15.3 – Kerb details and heights

Location	Upstand	Typical example
General	75mm to 125mm Half battered profile adjacent to footway Splayed (45°) where no adjacent footway and on high speed roads	
Pedestrian or cyclist crossing	Flush with tactile paving Any upstand makes it more difficult for wheelchair users	
Vehicle crossover	25mm To maintain continuity of edge of carriageway drainage and provide a continuation of the kerb line for blind or partially-sighted pedestrians	

15.1.26 Where a footway or cycle track is provided adjacent to a higher speed, or more heavily trafficked road the footway should be separated from the adjacent carriageway by a verge, typically at least 1m in width, in order to provide a margin between the active travel path and vehicular traffic. In most cases this margin is likely to be grassed.

15.1.27 On off-carriageway routes, a verge of between 0.5m and 1m should be maintained each side of the path. The mown edges prevent vegetation encroaching and making the footpath or cycle track unusable. The remainder of the verge may be left and may be valuable to wildlife.

15.2 Drainage

Introduction

15.2.1 Drainage systems should be considered at the earliest stages of design to influence the layout and route of the carriageway. Standing water and poorly-designed surface water run-off can cause problems for users and damage pavement construction. Keeping water off and moving it away from a carriageway or path will increase the longevity of the pavement structure and increase its use. Any drainage system needs to be efficient and reliable and may need to extend beyond the immediate edges of a new path to be effective.

15.2.2 Where the water comes from and how it is disposed of needs proper consideration as part of the route design. Poor drainage can lead to safety and maintenance issues. New surfaces must consider Sustainable Drainage Systems (SuDS) solutions that can help reduce the pressure on existing urban waste water systems, flood risk and water quality of receiving waterbodies.

Sustainable drainage

15.2.3 Schedule 3 of the Flood and Water Management Act 2010 came into force in Wales on 7 January 2019. Supported by a suite of secondary legislation it introduced a duty on developers to seek approval for Sustainable Drainage Systems (SuDS) to be used in the management of surface water. The Duty applies where the area covered by construction work equals or exceeds 100 square metres.

15.2.4 The Statutory SuDS Standards, which accompany the legislation, set out the requirements for the design, construction, operation and maintenance of sustainable drainage systems.

15.2.5 The policy seeks to manage surface water runoff in a way that both employs and mimics natural processes, with increased protection for property from the risk of flooding, within project designs. It promotes the management of surface water close to its source and close to the surface of the land, creating multi-functional spaces through better integration of drainage solutions with added amenity and biodiversity benefits.

15.2.6 The role of approving, and in appropriate cases adopting, the sustainable drainage system falls to the 22 SuDS Approving Bodies (SABs) in Wales, a function of the local authority.

15.2.7 The SABs must have regard to statutory standards and statutory guidance produced by the Welsh Government to assist with the interpretation and implementation of the policy. Requirements for drainage adoption and drainage maintenance arrangements are set out in these documents.

15.2.8 SuDS are viewed as one of the key tools for facilitating sustainable development and helping public bodies meet obligations under the Well-being of Future Generations (Wales) Act 2015.

15.2.9 The Statutory SuDS Standards set out the requirements for sustainable drainage systems in the following areas:

- surface water runoff destination
- surface water runoff hydraulic control
- water quality
- amenity
- biodiversity
- design of drainage for construction, operations and maintenance

- 15.2.10 The most effective SuDS use a series of various drainage components including planted areas, that work as an integrated process to control rain water flow rates and reduce volumes of runoff. The natural filtration provided by appropriate planting provides treatment to protect water quality and opportunities to encourage biodiversity and amenity.
- 15.2.11 Designing SuDS into new active travel routes at the earliest opportunity will help result in positive improvements that benefit both active travel and the environment. Costings for the SuDS element will be reduced by making the features an integral part of the amenity design, rather than expensive retrospective costs.
- 15.2.12 When it comes to the maintenance of SuDS, surface-based components which are visible in their operation and performance are generally simpler and easier to operate, monitor and maintain. These activities can normally be undertaken alongside or as part of routine management operations for any carriageway.
- 15.2.13 Well designed, easy to maintain SuDS will deliver a range of important benefits for the local environment and local communities, in addition to contributing to the delivery of the Water Framework Directive, local flood risk management, Local Biodiversity Action Plan objectives, Well-being of Future Generations (Wales) Act 2015 obligations and sustainable development consistent with the Planning (Wales) Act 2015.

On-carriageway drainage

- 15.2.14 On the carriageway, attention will need to be paid to gully location and levels, which are critical for cyclists comfort and safety as well as route drainage. This is particularly important where full or light separation for cycling has been introduced, since cyclists may find it difficult to avoid gullies. Acceptable gully characteristics are as follows:
- the grate slots should be at right angles to the direction of travel so that thin cycle wheels do not become trapped in them. Alternatively, non-slot 'pedestrian style' gratings should be provided
 - gully width should be less than a third of the overall cycle lane width
 - no gaps between the frame and cover wider than 15mm
 - recessed gully frames raised to be flush (tolerance +/- 5mm) with the surrounding surface
 - equipment suitable for their location to take public highway loadings; and
 - opened in a manner suitable to be cleansed by a normal gully cleansing or jetting machine under the local highway authority contract
- 15.2.15 Any gratings unsuitable for cycling across should be replaced. Side-entry gullies or perforated kerb type gullies may be suitable in some circumstances, particularly where there is restricted width and where cyclists will be close to the kerb.
- 15.2.16 Fully separated cycle tracks and stepped tracks will need additional gullies as well as appropriate falls to facilitate run-off. A minimum grating size of 300 x 300mm

is recommended, as the smaller size gully gratings that are sometimes used in off-carriageway situations tend to become blocked with leaf fall and other debris.

- 15.2.17 A gully should be provided in the carriageway at the upper side of any pedestrian/cycle crossing to prevent surface water running across the area in which people step into the carriageway. Every effort should be made to avoid water ponding at crossing points, including considering carriageway profiles and the location of appropriate drainage facilities during scheme construction and highways maintenance works.

Off-carriageway drainage

- 15.2.18 Where new routes are being constructed, or widened into soft verges, consideration should be given to the effects of an increase in the volume of surface water run-off on the existing drainage system. Once taken off the path surface it is essential that water is returned back into the drainage system at a suitable location. Simply diverting over land run off, or removal of flood water into the nearest ditch or culvert may create problems further downstream.
- 15.2.19 To prevent ponding of surface water, or the formation of ice, a crossfall or camber should be provided on the path surface within the limits stated in table 15.4. Excessive crossfall is uncomfortable to walk on and can cause difficulties for wheelchairs, pushchairs and cyclists.





Table 15.4 – Crossfall specifications

	Crossfall (%)
Minimum	1.5
Preferred	2.5
Desirable maximum	3.3
Absolute maximum (at crossings)	10

- 15.2.20 The direction of the crossfall should be set so that surface water does not run-off onto adjacent property where there is no highway drainage along the boundary. Typically, footways will fall towards the adjacent carriageway. On cycle tracks the crossfall should generally fall towards the inside of a bend.
- 15.2.21 Where it is not possible to provide a continuous crossfall across a path, either due to the relative levels between the kerb and the back of the path or the width of the path, it will be necessary to provide drainage channels within the path. Table 15.5 sets out four options.

15.2.22 If gullies or gratings are used as part of a path drainage system a heel proof grating should be specified.

Table 15.5 – Drainage channels on paths

Measure	Advantages	Disadvantages	Typical example
Dished channel blocks	Easy to maintain	Trip hazard Requires gullies Can result in ponding water Not suitable on cycle routes	
Flat channel blocks	No trip hazard Easy to maintain	Less capacity Requires gullies Can result in ponding water	
Linear channel with gratings	Can avoid having to create a low spot in a surface	Prone to blocking and silting up Gratings can work loose and cause trip hazards	
Linear slot drain	Visually un-intrusive Can have high capacity (in pipe below ground)	Prone to blocking and silting up Have to be jetted or rodded to be cleaned	

15.3 Access controls

- 15.3.1 Access controls are sometimes placed on off-carriageway routes to prevent access by unauthorised vehicles, particularly motorcycles.
- 15.3.2 Designers should start with a presumption against the use of any form of access control, installing only in response to evidence of actual problems of abuse of cycle and pedestrian facilities, and never simply in response to perceived problems.
- 15.3.3 Access controls can cause difficulties to many legitimate users and can render routes inaccessible to people who rely on mobility aids. Access controls are often ineffective in addressing the issues they are intended to prevent. Restrictive access controls:

- are inconvenient, can be unsightly and can actively discriminate against some user groups who have legitimate rights to use a path including disabled people and users of non-standard cycles
- extend the journey time for cyclists and so reduce the utility of a cycle route
- add another level of cost, and maintenance concern, to a path; and
- are frequently ineffective because fencing along a traffic free corridor is missing, broken or subsequently vandalised so that the access control can be bypassed

15.3.4 There is also a tendency to install access barriers to stop, or slow, cyclists at the end of a path for safety reasons – whether actual, or perceived. This is often inappropriate, and designers should consider other solutions such as clear signing or other means of slowing cyclists such as changing path geometry.

15.3.5 A single bollard, and clear sight lines will be effective in many locations. Double rows of bollards, with a minimum spacing of 1500mm can reduce cycle speeds and prevent motor vehicle access, whilst retaining better permeability for users than chicane barriers. See figure 15.2 below.

Figure 15.2 – Access control using bollards



15.3.6 The visibility of any access controls should be considered at the outset as part of the design process. Clear sight lines and the location of any lighting provision should be taken into account so that the control can be seen easily and additional visibility on the control should be included (e.g. reflective strips or contrasting colours).

15.3.7 Sustrans provides [detailed information on assessing whether an access control is needed](#), and if so the most appropriate design solutions. Assessment information includes:

- legal issues, including the Equality Act
- whether an access control is required
- alternative measures to control access

- risk assessment
- deciding on type of access control required
- design options

15.3.8 The design of routes where there is a perceived need for an access control solution should include engagement with users in the local area, including groups representing disabled people. When considering design options, authorities should use swept path analysis, as highlighted in figure 15.3.

Figure 15.3 – Swept path analysis through an access control

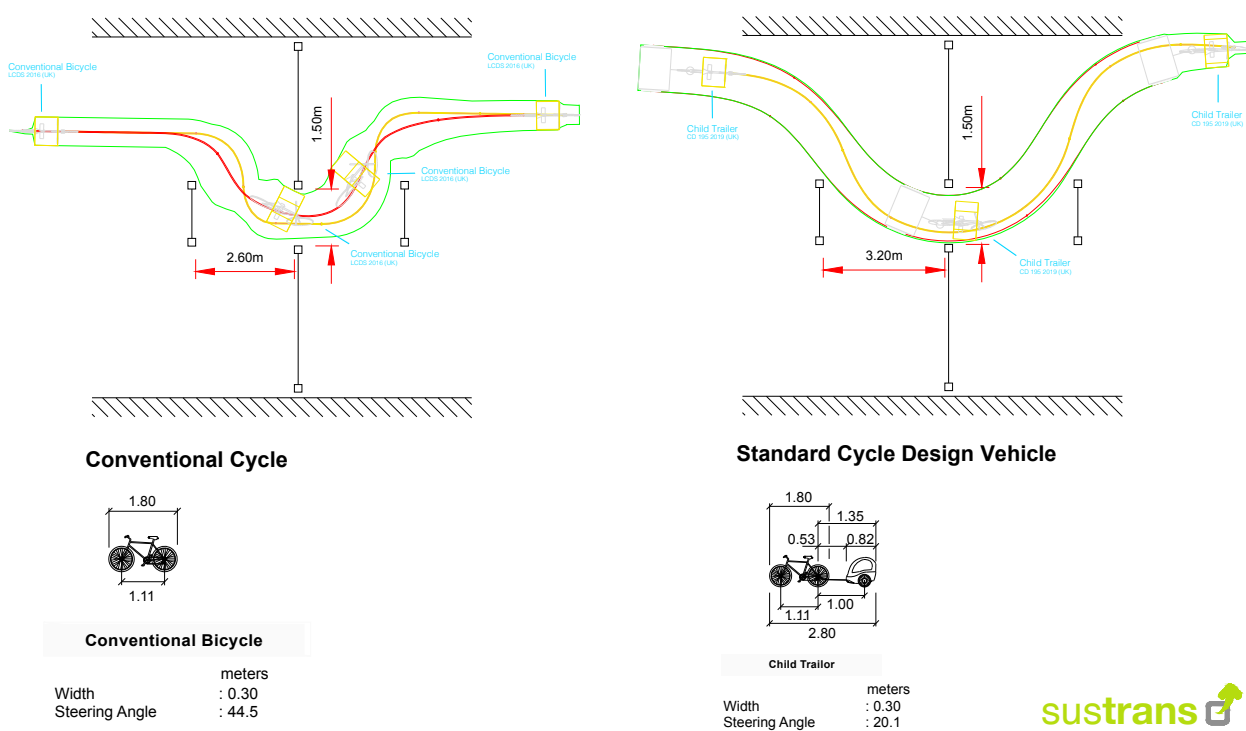

15.4 Fencing and hedgerows

- 15.4.1 Fencing may be required along off-highway paths for the safety of users, the security of neighbours and livestock control. Where needed fencing should remain visually unobtrusive.
- 15.4.2 New fencing has an impact upon all users, but especially cyclists as a fence immediately adjacent to the path edge reduces the useable path width by 500mm.
- 15.4.3 Fences set 1m away from a path edge will provide a better visual aspect, and reduce the “tunnel effect” where fences line both sides of a path. Verges also provide space for drainage and ducting for lighting.
- 15.4.4 Security fencing can be harsh and oppressive, creating environments that are visually off putting to pedestrians and cyclists alike. A 1500mm high fence should be adequate in all

but exceptional circumstances. To a pedestrian they still provide views over, and the visual and aesthetic impact to a traffic free route is considerably less than with a taller fence.

- 15.4.5 Hedgerows form part of the immediate environment for many paths away from or alongside the road. They also provide important habitats for wildlife and connectivity (both visually and for wildlife) to the wider landscape. Developing routes that include at least one hedgerow as a boundary feature can re-invigorate them as dead wood, brambles and unwanted species are removed and new growth encouraged. Thorny species such as Hawthorn or Dog Rose should be avoided, but if used will require planting further back from the path edge to prevent hedge clippings causing cycle punctures.

15.5 Lighting

- 15.5.1 Walking and cycling must be promoted as around-the-clock means of transport, rather than just a daylight activity, if active travel is to play an important role as an alternative to the car for everyday journeys. Many walking and cycle journeys will be made after dark, especially during the winter months.
- 15.5.2 Active travel routes should normally be lit to provide an adequate level of safety, both real and perceived. It is recognised that some authorities are looking to reduce lighting to reduce costs and light pollution, but the benefits of lighting a walking or cycling route include:
- enabling users to orientate themselves and navigate the route ahead
 - enabling users to identify other users ahead
 - enabling users to detect potential hazards
 - discouraging crime and increasing the sense of personal security
- 15.5.3 It is important that lighting is considered at an early stage in the design process, so that the issues can be properly explored and the needs of users taken fully into account in the choice of equipment and the design of the scheme. Early consideration also mitigates potentially costly retrofitting of lighting and associated equipment into designs. Efforts to minimise light pollution and spillage in rural areas will be particularly important. In addition, where lighting is proposed in an area previously unlit, the impact on light sensitive species such as bats which are protected by law must be carefully considered. LED in-path lighting, bat caps and/or motion detection lighting can all help to mitigate these concerns.

Figure 15.4 – Example of lighting on a shared route in Holywell



15.5.4 Routes along urban and many rural highways will be lit by the existing highway lighting but specific lighting will be needed for off-highway routes. However, in lighting such routes consideration also needs to be given to wider factors, including:

- limiting levels of light pollution
- level of ambient brightness in the surrounding area
- the visual impact of the lighting equipment
- intrusion on nearby properties
- the needs of visually impaired users for uniform illumination at surface level
- vandalism issues
- proximity of electricity supply
- energy usage and cost
- costs of installation, operation and maintenance

15.6 Maintenance and management

Introduction

15.6.1 Maintaining the path or carriageway surface is of great importance to pedestrians and cyclists, including high standard reinstatement following works by statutory undertakers (see also section 15.7 Streetworks). It is essential to establish responsibility for maintenance of paths that are not part of the highway and put into place a regular regime for inspections. Having invested time and money to build the route, it is important that it remains attractive to users. A route that is kept in good condition will be more useful and popular than one allowed to deteriorate.

15.6.2 Walking and cycling quality should be maintained, particularly keeping routes clean and ice free, in autumn and winter.

- 15.6.3 Highway authorities should therefore systematically look for synergies between their programmes for cycling and walking improvements and for planned highway maintenance, identifying opportunities to deliver cycling and walking improvements when carrying out planned highway maintenance works.
- 15.6.4 An example could include when road markings are removed during highway resurfacing, this creates an opportunity to reallocate part of the carriageway to cyclists or to widen existing cycle lanes. General traffic lanes can be narrowed, wide central hatching can be removed, and the resulting space given over to cycle lanes, which can also be protected with light segregation, all at minimal or low cost. Coloured surfacing for cycle facilities can also be introduced during planned resurfacing works, particularly at junctions and other potential conflict points.
- 15.6.5 The safety of pedestrians and cyclists is disproportionately affected by poor highway maintenance. Cycling UK reports that claims made as a result of poor highway maintenance are on average 13 times higher for cyclists than those made by drivers, because the claim is much more likely to involve personal injury.

Design with maintenance in mind

- 15.6.6 Maintenance should be considered as part of the route development process long before construction starts. A thoughtful design will mean less maintenance in the future. For example, an off-highway path surfaced with bituminous material will have a long life needing little maintenance, whereas a different surface treatment will need to be replaced more frequently.
- 15.6.7 The future maintenance burden on local highway authorities, both financial and operational, should be a major consideration for designers and it is recommended that both a value engineering and future maintenance audit are carried out on all proposed designs before implementation.
- 15.6.8 It is particularly important to think about maintenance at the start of the design process if the project has capital funding available, but maintenance will have to come from existing budgets. Sometimes money can be put aside from the capital source into a separate fund for future maintenance. Irrespective of what the arrangement will be, the design team should identify the future maintenance arrangements early in scheme development.
- 15.6.9 The Active Travel (Wales) Act 2013 mandates local authorities to improve conditions for active travel at every opportunity.

Maintenance responsibilities

- 15.6.10 Most active travel routes will be highways under the definition of the act (a highway being a route that the public has the right to pass and re-pass), but this does not mean that the highway authority is always responsible for maintenance. Where the route is on the road it will usually be the responsibility of the highways authority but some routes may well be the responsibility of another part(s) of the council – for example the education authority if the route is through school grounds, or the recreation department for parks and open spaces.

- 15.6.11 Every department with future responsibility for the maintenance of the route needs to accept those responsibilities at the outset of the project and allow for them in future budgeting.
- 15.6.12 Many local parks and former railway greenways have local volunteer groups supporting the council teams to carry out maintenance activities. They provide a hugely valuable role, ensuring the local community is involved in its local path and promoting its use, as well as keeping the path in good order.

Maintenance tasks

- 15.6.13 Each local highway authority will have its own defect intervention criteria as part of their 'well maintained highways' process and established safety inspection regimes based on the hierarchical status and functionality of each asset.
- 15.6.14 The following list, though not exhaustive, gives some indication on the type of defects that affect walking and cycling network safety and serviceability.

- Carriageway, footway and cycleway surface defects:
 - » broken/uneven riding or walking surface with defects meeting or exceeding applied intervention criteria
 - » worn riding or walking surface with suspect skid resistance – where appropriate, testing of the surface should be carried out to ensure adequate skid resistance for traffic expected to use it
 - » defective kerbs, edging and channels
- Drainage and utility covers maintenance:
 - » missing or damaged inspection or drainage covers and frames
 - » surface water flooding or severe standing water
 - » blocked surface water gullies and drainage systems
 - » ironwork surface texture
- Ironworks, such as drainage gullies and utility covers, are particularly hazardous for cyclists, being both slippery in wet conditions, and often associated with potholes which form around their edges. Where cycle routes are located on roads shared with traffic, such surface defects can lead to greater conflict, with people on bikes often having to make often risky manoeuvres.
- Guardrail, fencing and restraint systems:
 - » missing or damaged posts, rails or barrier likely to cause a potential danger or render system ineffective
- Signing, road studs and markings:
 - » missing, damaged or illegible sign faces
 - » damaged post or fixings
 - » insufficient headroom from underside of sign

- » insufficient offset from trafficked areas
- » post/sign obstruction to passage or visibility
- » loose sign brackets resulting in turned sign face
- » failures to reinstate signing, markings or coloured surfacing denoting active travel facilities
- » missing or damaged road studs
- » missing faded, worn or incomplete markings

- Street lighting, traffic systems, pedestrian and cycle crossings:

- » daytime lamp burn
- » lamp out
- » damage, corrosion to columns or posts
- » damaged/turned heads or lanterns
- » missing/loose access doors to columns or cabinet
- » missing/damaged tactile paving at crossing
- » missing/damaged tactile rotating cone on crossing

- Verge, trees and hedges – on both rural and urban routes:

- » obstructed visibility or physical obstruction to free passage by vegetation, particularly at junctions and crossing points; cuttings to be kept clear of path surface
- » root heave to surrounding walking or cycling surface
- » obvious damage, disease or poor condition of any tree within falling distance of the route
- » need for periodic cutting back of adjacent grass verges or banks to maintain full width of asset

- Cleanliness and weed growth:

- » unacceptable levels of leaf litter likely to cause drainage or safety issues for users
- » unacceptable levels of litter, detritus or dog fouling
- » sign face cleansing
- » unacceptable levels of weed growth
- » presence of noxious weed growth
- » programmed cleansing of litter/dog fouling bins

15.6.15 A poorly cleansed surface, apart from discouraging users, can present real dangers to the user. Bypasses and gaps for cyclists do not benefit from the movement of motor

traffic to push debris out of the way, so these need to be of sufficient width for street sweepers and be regularly swept if they are to be usable.

- 15.6.16 Broken glass is one of the more obvious dangers to both cyclists and walkers. Excessive leaf litter or detritus build up can cause potential slip hazards and impact on the efficiency of surface water drainage infrastructure.
- 15.6.17 Failure to control weed growth or to maintain hedgerows and verges can have a detrimental effect on the safety and serviceability of an asset as well as its attractiveness to users.

Bridges and other structures

15.6.18 Bridges usually have a separate inspection and management system from the rest of the highway and traffic free networks. Bridge owners such as local councils and Network Rail have sophisticated bridge management systems. These tend to focus on the structural condition of the bridge and can pay less attention to the environment of the bridge.

15.6.19 Thus graffiti can remain indefinitely unless reported to the council, making the whole environment look uncared for and potentially feel threatening for walkers and cyclists. Underpasses provided for pedestrians and cyclists to avoid busy roads are particularly vulnerable to this type of abuse making their use off-putting and an unattractive experience.

15.6.20 Smaller bridges in parks and similar traffic-free environments sometimes have wooden decks. Unless these are treated with a good antiskid surfacing material at the time of construction they can become very slippery when wet. Once again, by considering the maintenance problems at the design stage, potential problems can be avoided before they become significant.

15.6.21 It is important to keep trees and bushes cut back close to bridges to allow inspectors a clear view of the structure and to avoid damage. Trees and bushes can affect masonry and cause damage to paintwork.

Winter maintenance

15.6.22 Local highway authorities are under a duty to ensure, so far as reasonably practicable, that safe passage along a highway is not endangered by snow or ice. Whilst this is not an absolute duty due to the qualification of 'reasonable practicality', the Active Travel Act raises the priority of walking and cycling routes and this should be reflected in local authority's winter maintenance programmes.

15.6.23 It is not reasonable, due to the scale and cost to expect local authorities to apply this service to the entire highway network or ensure that treated sections of the network remain ice or snow free. However, well used walking and cycling routes should merit a high priority in the same way that major motor vehicle routes are considered. It is not uncommon for people to travel on foot when there is heavy snow as often roads become unusable. There is also an equalities issue to keep pavements clear of snow and ice as older people or those without access to a car continue to rely on being able to walk to local services in all weathers.

15.6.24 It is therefore recommended that local highway authorities:

- undertake risk assessments of which parts of the cycling and walking network should be identified for treatment in winter service plans
- engage cycling and walking stakeholders and users in the development of policies, winter service and operational plans
- advise and inform walking and cycling network users and stakeholders on the extent of the service and safe use during these periods

Highway enforcement and custodianship

15.6.25 Although not strictly a maintenance function, local highway authorities also have a duty to assert and protect the rights of the public to the use and enjoyment of any highway, including active travel routes.

15.6.26 The following list, though not exhaustive, shows typical enforcement or controlling actions that may need to be taken to ensure compliance with statutory duties in relation to walking and cycling. All the following have the potential to cause unnecessary obstruction or potentially unsafe conditions for both cyclists and pedestrians and should be addressed by the local authority or police, as appropriate. Local authorities should consider how they can enable the public to easily report these infringements:

- placing of builders materials or skips within the highway
- scaffolding within the highway
- 'A' boards placed within the highway
- parking of vehicles, trailers or caravans on the footway and across dropped kerbs
- parking of vehicles, trailers or caravans on carriageway or cycle tracks so as to cause an obstruction
- illegal signing within the highway
- privately-owned vegetation encroaching on the highway
- mud and soil deposited on the highway; and
- control of statutory undertakers and maintenance works

15.7 Pedestrian and cycle traffic at streetworks and construction sites

15.7.1 In the operation and maintenance of highway networks, it is necessary from time to time to put in place temporary traffic management measures to facilitate safe road works, temporary closures or incident management, whilst keeping the traffic flowing as freely as possible. These streetworks can affect all user groups and may impair the safety and free movement of vehicles, cyclists and pedestrians (particularly blind, partially sighted

and disabled people). All steps must be taken to ensure that the effects of the works are reduced to a minimum.

- 15.7.2 Poorly planned temporary traffic management can be a danger to pedestrians and cyclists or make routes inaccessible to disabled people. Even if the actions are unintentional, e.g. parking a works vehicle on the footway, they can easily cause an obstruction to the route which places pedestrians and cyclists at risk in negotiating around the vehicle or the street works or road works site. This obstruction can make the whole journey unattractive causing potential walkers or cyclists to switch to a less sustainable travel mode.
- 15.7.3 Under part 3 of the New Roads and Street Works Act 1991, local authorities and statutory undertakers must have regard to the needs of pedestrians and cyclists in:
- granting street works licences
 - giving directions as to the timing of street works
 - the placing of apparatus
 - restricting street works following substantial road works
 - exercising their duty to co-ordinate works, and
 - giving consent to place apparatus on a protected street
- 15.7.4 Local authorities, highway authorities and statutory undertakers must consider the effects that street works and road works may have on pedestrians and cyclists and addressing this will form part of the co-ordination process. Highway authorities must seek to minimise any disruption for pedestrians and cyclists when giving any directions or placing any restrictions on street works.
- 15.7.5 'Safety at Street Works and Road Works: a Code of Practice 2013' (The Red Book) and chapter 8 of the 'Traffic Signs Manual 2009' highlights the responsibilities of the designers of the works and traffic management to undertake risk assessments of the street works or road works site and the associated works in designing the temporary traffic management scheme.
- 15.7.6 Each street works or road works site will have different characteristics in terms of layout, available widths, pedestrian, cyclist and vehicle flows, etc. and these need to be assessed to meet the needs of all road users.
- 15.7.7 On active travel routes special consideration must be given to pedestrians and cyclists. If provision cannot be made, then the designer must consult with their client or commissioning organisation regarding alternative provision. Such an alternative may be the provision of a diversion route that offers the minimum dimensions set out in this Active Travel Act Guidance.
- 15.7.8 The needs of all pedestrians and cyclists shall be fully considered when putting in place any alternative arrangements. Wherever possible, maintaining access for pedestrians

and cyclists should be a priority during street works and road works and in particular to consider whether any change from a separated route to an on-carriageway route is appropriate, safe and accessible to users. When it is necessary to close a road to motor traffic but it can remain open for walkers and cyclists, this should be made clear with appropriate signage.

- 15.7.9 Further details on appropriate measures for certain route scenarios are outlined within [115/20 Supplementary Guidance for the Safety at Streets Works and Road Works - A Code of Practice 2013](#).

Figure 15.13 – Streetworks with active travel provision



Chapter 16:

Monitoring and evaluation

This chapter sets out why monitoring and evaluation of active travel routes and schemes is essential to help understand their impact and provide an evidence base for future investment. It also includes information on how this should be carried out.

Key areas of consideration include:

- a monitoring and evaluation plan should be developed for any new active travel routes and schemes
- the investment in data gathering needs to cost-effectively establish the outcomes and impacts
- some pertinent data might already be available from existing national or local datasets
- the output from the analysis will need to be expressed clearly to communicate the findings to a range of stakeholders

16.1 Introduction

- 16.1.1 Authorities should establish a programme of active travel monitoring, which will create a baseline for measuring future improvement and progress towards targets and policy goals. Over time, this will lead to the establishment of a catalogue of local data which is important for being able to make the case for future investment. Being able to demonstrate the impact of past investments can be particularly helpful when potentially controversial schemes are being developed.
- 16.1.2 Monitoring should often cover more than just levels of use of a route. For example, local authorities may wish to record changes in the number, severity and type of collisions at a particular site, or they may wish to record modal share at nearby schools or employers before and after a new route is implemented, or demographic characteristics of users.
- 16.1.3 The act requires local authorities to measure and report upon changes in levels of use on active travel routes every time a revised map is submitted – usually every three years. Appendix F provides the current template for these reports. This chapter explores reasons for monitoring and evaluation and how it can be approached.
- 16.1.4 As part of the development of individual improvement schemes, monitoring should be incorporated as a key element from the outset and should be built into projects. The type of monitoring that is undertaken will depend upon factors most relevant to a specific scheme.

16.1.5 As noted in chapter 3, Llwybr Newydd has set a target of 45% of journeys to be made by public transport, walking and cycling by 2040. This represents a significant increase from the estimated current mode share of 32%. This figure will be kept under review, with local authority active travel scheme monitoring helping inform the overall picture of progress against this target. Gathering pre and post scheme data as part of active travel infrastructure improvements is therefore important. A national evaluation framework is being developed to monitor progress towards the commitments in Llwybr Newydd. The framework will include quantitative measures across all modes using both new and existing sources of data, and will report annually.

16.2 Why monitor and evaluate?

16.2.1 Gathering data about the usage and impact of routes provides a justification for existing plans and schemes, helps make the case for new proposals and with exploring future options. Typically monitoring will be used to:

- compare and prioritise scheme design options
- compare active travel schemes with other local transport schemes
- assess if schemes are having the desired impact and represent value for money
- review operation of an experimental scheme, prior to deciding on whether to make it permanent
- assess changes in travel behaviour post-implementation
- assess the operation of innovative schemes to learn lessons on how the design might be improved in future

16.2.2 When planning a new route or network, or improvements to existing infrastructure, data from other similar interventions and networks can be used as the basis for forecasting how usage or safety might change following the intervention, and thereby making the case to support the proposition.

16.2.3 Baseline data should be used to inform the identification of active travel proposals and this may include collecting relevant non-active travel data. For example, where an active travel proposal has been identified within an existing highway corridor, data relating to traffic flows, speeds and the number of HGVs should be collected to help identify whether on-road or off-carriageway interventions may be more appropriate.

16.2.4 The Welsh Government and other funders expect to see evidence of the impact of a scheme post implementation. The case for future funding and support during public consultation can be enhanced by evidence from a quantified (and qualitative) examination of usage.

16.3 How to approach monitoring and evaluation

16.3.1 A monitoring and evaluation plan shall be developed for all new active travel routes and schemes and the costs of this should be factored in when estimating costs for the overall project. The plan would typically be a variant of a logic map or logic framework (an example is given in figure 16.1) – a systematic and visual presentation of the key steps forming a monitoring programme based on the scheme objectives. Schemes will have both outputs and outcomes derived from the project objectives.

16.3.2 This requires the identification of:

- SMART objectives (Specific, Measurable, Achievable, Realistic and Timed)
- inputs – what is invested in the project. Examples include: Money, skills, people, activities (such as pedestrian (e.g. Kerbcraft) or cycle training etc.)
- outputs – anything that is delivered from a project activity. These are usually quantitative. Examples include: Number of participants in project activities, number of crossing points/junctions improved, number of activities delivered, length of cycle route provided, number of champions recruited, etc
- outcomes – the short to medium term results that is generated through the delivery of outputs. This is the change that is brought about through the delivery of the project activities e.g. increased walking and cycling
- impacts – the long-term results from the intervention e.g. reduced congestion, improved wellbeing

Table 16.1 – Components of an intervention logic map

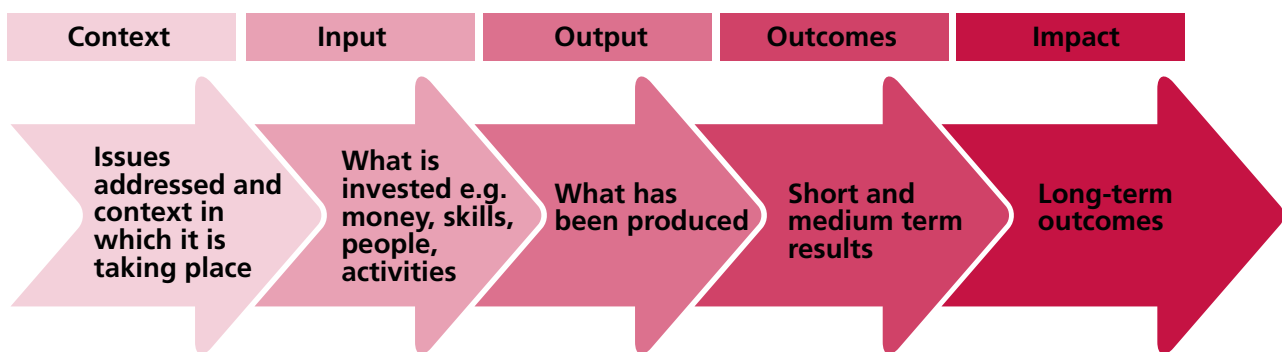

16.3.3 The information in table 16.1 below gives examples of a range of active travel outputs and outcomes.

16.3.4 Additional columns have been added to the basic logic map to capture information on how you plan to measure the impact of the project. This includes the indicator that will be used, the method of data collection and the frequency of data collection. The impact, indicator, method and frequency of measurement for each output or outcome should be entered on a new row in the table.

Table 16.1: Example of a simple logic map for active travel

What does the project aim to deliver?		What is the change you expect to see?				How do you plan to measure this change?	
Objective	Input	Output	Outcome	Impact	Indicator	Method	Frequency
Enhanced accessibility	Infrastructure improvements, barrier removal	Number of dropped kerbs delivered, barriers removed	Improved provision for accessible users	Improved access for users	Number of accessibility upgrades delivered	Construction log, EQIA	Captured continuously, reported quarterly
				Increased access for all users, particularly disabled users	Positive feedback from accessible users about changes	User survey or perception survey or community survey	E.g. Captured before and after delivery
Improve pedestrian provision	Pavement widening, signage improvements	Kilometres of pavement widened, number of signs installed, number of kerbs realigned/dropped	Positive perceptions of walking	Better public environments, higher footfall	Number of pedestrian improvements delivered; km of pavement upgraded	Construction log	Before and after delivery
					Positive feedback from pedestrian or local community about changes	Perception survey	Continuously captured, reported quarterly
Improve cycling safety	Infrastructure improvements, resources	Physical route, Signing	Increased usage, improved perceptions of the route	Reduction in incidence of accidents, congestion reduction	Number of accidents/reduced congestion	Accident logs/automatic counts	Annually, quarterly, monthly
				Increase in cycling users, increase in diversity of cycling users, reduced health burden of accidents	Positive feedback from cyclists and/or local community about changes	User survey or perception survey	Before and after intervention delivery

Notes: After developing the Outputs and Outcomes the rows have been split to highlight how different Impacts can be measured.

- 16.3.5 The monitoring and evaluation plan should consider the characteristics of the scheme or network in question. The data to be collected should directly address the intended outcomes and impacts, and should relate to what is on the ground. e.g. is there a suitable location for an automatic counter on the route or network? Are there schools or workplaces that are served by the route or network where data can be collected by surveys and other methods?
- 16.3.6 Consideration should also be given to unintended consequences, such as the possibility that certain users may avoid a route following an intervention. It will not always be easy to ascertain, but good baseline data that identifies the existing level of use by type of user will enable an evaluation of changes in the mix of users.
- 16.3.7 Consideration should be given the timing of data collection across years for consistency i.e. comparable months and weather patterns. This is very important for usage data as there is a natural curve of seasonal behaviour that changes throughout the year (increased walking and cycling in warmer months, but less in winter months). Collecting perception data at differing months of the year is less problematic as this usage pattern is not such an influence.
- 16.3.8 The investment in data gathering needs to cost-effectively establish the outcomes and impacts. Cost can be a key constraint and the scaling of costs is not a simple formulaic matter. If a more detailed data set is required, costs are inevitably higher. A low-cost scheme may not necessarily correspond to a scheme with a minimal data requirement. Examples of historic monitoring approaches have included circumstances where 1% of a multi-million pound investment has been spent on monitoring, and others where monitoring has amounted to a quarter of total project cost. This shows there is no specific proportion that can be used to determine a monitoring and evaluation budget. Rather, the monitoring and evaluation budget should be specific to each scheme and include the activities required to reasonably measure the impact of the planned active travel intervention.

16.4 Data gathering tools

- 16.4.1 It isn't common to collect data on walking unless specific to a scheme, and the collection of data on cycling varies enormously both in consistency and extent. Most monitoring of walking and cycling relates to levels of use, with less attention to patterns of use, type of user or user satisfaction.
- 16.4.2 A wide range of tools for data collection is available. These should be selected according to the information requirements identified to demonstrate the scheme objectives in the monitoring and evaluation plan. Some pertinent data might already be available from existing national or local datasets that could meet the project's needs before embarking on further data collection, e.g. traffic flows, air quality, speed data.
- 16.4.3 Table 16.2 lists common monitoring tools for active travel, indicative costs and their scale of application.

Table 16.2 – Data collection methods available for monitoring

Tools	Key Issues to Consider
Automatic pedestrian/cycle or motor vehicle traffic counts	Initial investment costs are high due to hardware costs and there is an ongoing maintenance liability; extent of costs depends on number of counters required, and intensity of coverage required; costs can range from £1,500 to £5,000 per counter unit, depending on specification, but greater for complex locations. Ongoing maintenance costs are also a consideration but should be seen as part of the transport network monitoring
Manual pedestrian/cycle or motor vehicle traffic counts including cordon counts	No hardware costs, but an ongoing cost in commissioning repeat counts; frequency and the number of points to be covered are the primary determinants of cost; expect to pay a standard day rate per count day per site per iteration. Cordon counts are manual counts of users passing across a specified boundary i.e. zone
Video monitoring, including counts	Video technology can capture (non-continuous) usage counts, and/or be used to monitor how infrastructure is used by the public. Data capture period is usually one week Modest hardware and installation or commissioning costs. Can be resource-intensive to analyse; technology for automated analysis is developing
Cycle parking counts	Cost depends on area to be covered; expect to pay a standard day rate per person required per iteration
Beneficiary and participant count record and surveys	Based on four days coverage per survey event, usually using two people per site; fieldwork cost varies by location and provider (approx. £2,000 - £7,000)
User surveys	Can capture quantitative and qualitative data on travel behaviour and perceptions around a project. Targeted at specific beneficiary; data captured via household postal survey or via local community / groups / schools / workplaces, etc. Cost varies by scope and audience. Social media and self-selected web-based surveys will not provide a representative sample, but can be useful tools to gather perception data. Qualitative data requires additional resource to analyse
Perception survey (community/household or other beneficiary)	Can capture quantitative and qualitative data on travel behaviour and perceptions around a project. Targeted at specific beneficiary; data captured by household postal survey or by local community/groups/schools/workplaces, etc. Cost varies by scope and audience. Social media and self-selected web-based surveys will not provide a representative sample, but can be useful tools to gather perception data. Qualitative data requires additional resource to analyse
Household travel behaviour survey	Best suited to measuring travel behaviour change over time where an extensive programme of active travel interventions is being delivered. Usually very expensive for very strong data; survey design and sampling are part of the process, but the bulk of the cost is surveyor time; key cost determinants are level of coverage with respect to sample size and statistical surety; expect to pay £40,000-90,000 per iteration; typical sample size required would be around 1000 households
Interviews and focus groups	Used to capture qualitative data from scheme beneficiaries, relevant if interventions are targeting benefits for a specific user group. Low-cost to capture and analyse if carried out at a reasonable scale
Anonymous data collection methods e.g. mobile apps or Bluetooth surveys	Can provide a variety of data types on the volume and characteristics of journeys at specific points. This is a constantly evolving area although this type of technology can rely on movements across mobile phone tower reception boundaries to capture data

16.5 Recommended approach

16.5.1 Table 16.3 provides a range of options and monitoring techniques that are available to local authorities when developing and delivering active travel schemes. To provide some consistency it is recommended that as a minimum the following elements are included as part of any monitoring and evaluation plan.

Table 16.3 – Recommended minimum level for project development

When required	Tool	Monitoring outcome	Rationale	Timing and frequency
All infrastructure schemes expected to influence levels of walking and cycling trips through new or improved provision	Pedestrian and cycle counts. These could be manual or automatic (e.g, traditional cycle counters or video/AI equivalents)	Levels of active travel use	To understand existing levels of active travel use and potential demand for interventions, before construction. Post-construction, to capture the realised levels of usage Relevant to all infrastructure schemes expected to influence levels of walking and cycling trips through new or improved provision	The surveys should be undertaken over 3 or 4 days, including both weekdays (ideally Tuesday to Thursday) and weekends. Best carried out in spring and autumn during neutral months March to June and September to November Repeated annually at a comparable time of year for minimum of 3 years as part of post-completion monitoring
To be used where a project is near to a school (within 2 miles for primary schools, 3 miles for secondary schools) and/ or expected to influence travel behaviour to/ from a school	Hands-up surveys, or travel tracker tools (As part of school travel plans, other interventions, or Public Health Wales’ annual survey)	Mode of travel to school	To understand travel patterns and behaviour associated with proposals based around schools.	Carried out during pre-design to capture existing travel pattern during the spring or autumn term (including the neutral months of April, May, June, September and October) Where available, data from the Public Health Wales hands-up survey is proposed to be collected during the 2nd or 3rd week in September Repeated at least annually for a minimum of 3 years as part of post-completion

<p>This will be relevant to all route and network proposals (not for minor works)</p>	<p>Community (or household) perception survey</p>	<p>Stakeholder perceptions and expectations around an intervention. Can capture quantitative and qualitative data on travel behaviour</p>	<p>Pre-scheme To help understand user needs and aspirations, inform the scheme objectives and provide baseline data pre-construction</p> <p>Post scheme To provide evidence of impact of the intervention post-construction. Should consider the relevant household or community area to include in data collection as being near to the scheme including whether any schools, activity clubs, community centres or local businesses should be targeted in the data collection</p>	<p>Should be carried out during scheme development and repeated following completion of the project</p>
<p>This will be relevant to all schemes</p>	<p>User surveys</p>	<p>Levels of active travel use, provides additional data relating to active travel journeys including wider benefits and can be used to validate automatic counts.</p>	<p>To provide a detailed measure of usage, including a count and additional information about the usage observed, specific to the location where the survey is carried out. A comparison of any pre-construction and post-construction user surveys will demonstrate an increase in usage. This will be relevant to any schemes expected to influence walking and cycling usage through new or improved provision</p>	<p>The surveys should be undertaken over 3 or 4 days, including both weekdays (ideally Tuesday to Thursday) and weekends. Best carried out in spring and autumn during neutral months March to June and September to November.</p> <p>Repeated annually at a comparable time of year for minimum of 2 years as part of post-completion monitoring (and then moving to a rolling programme of user surveys across the network on a rotational basis)</p>

16.5.2 Where schemes connect to educational establishments or large employers, it may also be appropriate to undertake school or workplace travel surveys in addition to the methods identified above. This will allow for the collection of data relating to levels of active travel use and travel behaviour, as well as additional information regarding barriers to active travel and attitudes to health, air quality and the environment.

16.6 Analysis, results and outputs

- 16.6.1 The analysis should be planned at the stage of designing the data collection approach. It should be designed to assess progress towards the stated objectives of the scheme and consequent output requirements identified in the monitoring and evaluation plan.
- 16.6.2 Attributing an impact directly to a project or scheme, especially an area-wide intervention, can be complex as other factors are often at work. It is relatively easy to report on the usage of a short stretch of route if counter and/or user survey data is available. However, this approach can risk significantly underestimating usage on a more complex network due to the failure to account for the parts of the network not covered by data collection activity.
- 16.6.3 In response to this, anonymous data collection methods such as mobile apps or Bluetooth surveys are being developed that go beyond traditional approaches and provide a variety of data types on the volume and characteristics of journeys at specific points. This data can then be used as a proxy for the usage on the surrounding area. It allows geographically distinct sources of data, collected on a network of routes, to be combined to estimate use across that network. This approach can generate a single annual usage estimate (broken down by user type) for a walking or cycling infrastructure scheme for both pre and post (where data permits) scheme construction and options to include it at the early development stage should be considered as part of the plan.
- 16.6.4 The output from the analysis will need to be expressed clearly to communicate the findings to a range of stakeholders and its content and format should be determined at the outset in the monitoring and evaluation plan. Any analysis output should relate back to the specific intervention objectives and outcomes, providing evidence of how a scheme has achieved its intended purpose.
- 16.6.5 Options for data analysis might include:
- measures of levels or changes of walking and cycling
 - measures of or change in:
 - » levels of walking and cycling among particular user groups
 - » levels of walking and cycling by journey purpose
 - » percentage mode shift from car to active modes on the route
 - » safety and perceptions of safety
 - » perceptions of facets of a route
 - » health benefits associated with a route
 - » carbon emissions savings and air quality benefits
 - benefit to cost ratio of a route

16.6.6 Presentation of monitoring results must have regard to the target audiences and be accessible to them. Whilst a detailed analysis may be appropriate for a more technically minded audience, a more visual representation of key results will be more suited to others, including decision makers and the general public. The local authority's high level monitoring and evaluation framework that sits above individual scheme monitoring plans will help determine what type of reports are best for particular audiences.

Figure 16.2 – Example of monitoring results¹



Everyone benefits when more people cycle

Every day, cycling in Cardiff takes up to

14,000 cars off the road

Based on cycling by residents that live in a household with a car. Does not include leisure cycling trips.

Every year, cycling:

-  prevents **123** serious long-term health conditions
-  saves **6,500 tonnes** of greenhouse gas emissions
-  creates **£33.7 million** in economic benefit for individuals and the city

There is significant appetite in Cardiff for cycling.

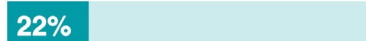

of residents cycle at least once a week

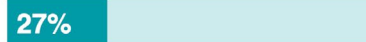

don't cycle but would like to

¹ https://www.sustrans.org.uk/media/5946/bikelife19_cardiff-v73_eng_web.pdf

09 APR 21

15:42

Today you are cyclist no:
Heddiw chi yw beiciwr rhif:

5234

One of:
Un o:

5234

this year
eleni

Glossary of commonly used technical terms

Key term	Description
Annual Average Daily Traffic Flow (AADT)	The average over a full year of the number of vehicles passing a point in the road network each day
Accessible (transport)	Transport services and infrastructure that meet the relevant policy and regulatory standards on equality, access, human rights and the Welsh language, recognising the social model of disability
Active Travel	Active travel is a term used to describe walking and cycling for utility or purposeful journeys, as opposed to recreational walking and cycling
Active Travel (Wales) Act 2013	The legislation, unique to Wales, which places duties on local authorities and the Welsh Ministers with an aim to make walking and cycling the most natural and normal way of getting about. https://www.legislation.gov.uk/anaw/2013/7/contents Abbreviated to 'the act' within this document
Active Travel Network Map (ATNM)	Active Travel Network Maps, introduced in the 2020 consultation draft of this guidance, combine the Existing Routes Map (ERM) and Integrated Network Map (INM) required by the Active Travel (Wales) Act. An ATNM consists of Existing Routes, Future Routes and Related Facilities
Active Travel Route	A walking and/or cycling route that enables utility journeys by connecting trip origins with destinations
Audit (Route)	A systematic assessment of a walking or cycle route, taking into account factors such as the infrastructure type, dimensions, condition, as well as contextual factors
Basic Network	The basic network, also referred to as local network, refers to local quiet streets where observed low traffic speed, road design and low volumes of traffic make them suitable for walking and cycling, without need for designated cycling infrastructure
Cyclist	The definition of a cyclist under the act includes all users of a cycle
Cycle (noun)	The term cycle includes all forms of bicycle, tricycle, or a cycle having four or more wheels, adapted cycles, including cargo and electric cycles, but not motorised vehicles

Key term	Description
Cycle Lane (mandatory, advisory)	<p>The term cycle lane has the meaning given in Schedule 1 of the Traffic Signs Regulations and General Directions 2016 (as amended).</p> <p>“part of a carriageway of a road reserved for pedal cycles which is separated from the rest of the carriageway”</p> <p>An advisory cycle lane is indicated by a broken white line</p>
Cycle Track	The term cycle track is used in its wider sense (rather than the legal definition) to describe routes for cycling within the highway boundary that are physically separated from motor vehicles and pedestrians, such as by a kerb, verge, level difference or material delineation (LTN 1/20)
Data Map Wales	Welsh Government digital mapping application which Local Authorities must use to record and submit their ATNM
Designated Localities	Settlements defined by Direction by Welsh Ministers to which the Active Travel Act’s mapping duties apply
Existing Route	A term used in the act. Refers to an active travel route that has been audited against a set of Welsh Government specified criteria and deemed suitable for walking, cycling or both. Collectively they make up the Existing Routes layer of the ATNM
Future Route	Previously known as Integrated Network Map routes, Future Routes are either routes that do not yet exist, or routes that fall short of the threshold to be classified as an existing route and require improvement. Collectively they make up the future routes layer of the ATNM
Highways Authorities	Have a duty to assert and protect the rights of the public to use and enjoy any highway for which they are an authority. As Highways Authority for the motorway and trunk road network in Wales, Welsh Ministers must maintain them at public expense and comply with other regulations
Infrastructure	Transport infrastructure includes all the things that enable transport services to operate – streets and roads, railway lines and active travel networks such as cycle-paths and footpaths. It also includes associated structures such as stations, bridges, embankments, car parks, signage, signalling, bus stops and transport interchanges and the soft estate – land and green-space associated with transport
Low Traffic	There is no firm definition of low traffic volumes, but up to 2500 vehicles per day is a typical cut off in an urban setting
Low Traffic Neighbourhood (LTN)	An area usually still open to motor traffic access, but where through traffic is greatly reduced via measures such as planters, bollards, or one-way motor traffic flows
Mesh Network Density	If a settlement is imagined as a grid this analysis allows the number of routes to be measured within a 1km square. It is the Welsh Government’s aim to achieve a mesh density of cycling routes in designated settlements of approximately 250 metres

Key term	Description
Modal Filter	A modal filter restricts the type of vehicle that can use a through-route, often a simple measure used in residential areas that can enable a more pleasant street environment whilst retaining residential and emergency vehicular access
Modal Shift	In the context of this guidance, modal shift refers to where a journey undertaken by another mode of transport (e.g. private car) is replaced with another mode such as walking or cycling
Passenger Car unit (PCU)	A standardised measure of traffic flow or capacity, where a car equals 1pcu, a motorcycle 0.4pcu, a bus 2pcu, and a HGV 2.3pcu.
Primary/Follow-me position	The position centre of carriageway which cyclists should adopt in certain circumstances when interacting with vehicular traffic. See National Standards of Cycle Training/Bikeability for a full explanation
Primary walking route	Routes between major trip generators with high volumes of pedestrians
Propensity	In the context of this guidance, propensity refers to the potential untapped usage of an active travel route or related facility
Public Right of Way (or PRoW)	A route over which users have a right to roam in accordance with the designation of the right of way. These comprise Footpaths, Bridleways, Restricted Byways and Byways Open to All Traffic. All public rights of way are highways and are shown on the Definitive Map held by local highway authorities, which is required to be constantly reviewed and updated
Related Facility	These are – usually publicly accessible – installations for use by pedestrians and cyclists. These include for example parking and storage for cycles, toilets and washing facilities, seating, as well as signage
Separated	A route where pedestrians, cyclists and motor traffic all use separate, often adjacent, alignments (e.g. pavement, cycle track and carriageway)
Sustainable Transport Hierarchy	Guides decisions about new infrastructure and gives priority to walking and cycling and public transport, followed by ultra low emission vehicles and finally private motor vehicles. It is set out in Planning Policy Wales (PPW) 11
Utility Journey	A journey made for the purpose of getting to a destination. For example to go to or return from work, to school, access a service or a leisure destination, make a visit, or go shopping
Transport for Wales (TfW)	The body established by Welsh Government to deliver transport priorities in Wales
Walker (or Pe-destrian)	The term “walker” (or pedestrian) includes those who travel by foot (walking or running) and users of wheelchairs or other mobility aids. Somebody using an electric wheelchair, mobility scooter, or similar vehicle would also be considered a walker rather than a motorised travel user.
WelTAG	A framework for assessing the impact and benefits of proposed transport interventions such as schemes to upgrade roads. It is aligned with the seven national well-being goals.

Appendix A

Powers and duties created by the Active Travel (Wales) Act 2013

Powers of local authorities

- S.2(1)(b) Power to determine whether a route is appropriate for active travel.
- S.3(10)(b) Power to revise the existing routes map without requiring submission to the Welsh Ministers.
- S.4(2) Power to determine what infrastructure is required to develop or enhance the active travel network.

Duties on local authorities

- S.2(6) Duty to take certain factors and guidance into account when determining whether a route is appropriate for active travel.
- S.3(1) Duty to prepare an existing route map and submit it to the Welsh Ministers for approval.
- S.3(3) Duty to consult on the existing routes maps.
- S.3(4) Duty to have regard to guidance on preparing and consulting on the existing routes map.
- S.3(5) Duty to submit existing routes map within a fixed timescale.
- S.3(6) Duty to submit a statement and explanation of standards of routes on the existing routes map to the Welsh Ministers.
- S.3(7) Duty to submit a report on the changes in level of use of active travel infrastructure whenever re-submitting the existing routes map for approval (only applies after the first map).
- S.3(10)(a)-(c) Duty to keep the existing routes map under review, and to resubmit it for approval every time the integrated network map is submitted for approval.
- S.4(1) Duty to prepare an integrated network map and submit it to the Welsh Ministers for approval.
- S.4(3) Duty to consult on the integrated network map.
- S.4(4) Duty to consider the desirability of active travel whilst preparing the integrated network map.
- S.4(5) Duty to have regard to guidance on preparing and consulting on the integrated network map.
- S.4(6) Duty to submit integrated network map within a fixed timescale.
- S.4(9)(a)-(c) Duty to keep the integrated network map under review, and to resubmit it for approval every 3 years.
- S.5(1)-(3) Duty to publish maps and the statement and explanation. S.5(2) – duty to have regard to guidance on publishing maps.
- S.6 Duty to have regard for the integrated network map when preparing local transport plans.
- S.7(1) Duty to make continuous improvement to active travel routes and facilities.

- S.7(2) Duty to have regard to guidance on continuous improvement.
- S.7(3) Duty to report to Welsh Ministers on costs incurred while making continuous improvement.
- S.9(1) Duty to take reasonable steps to enhance active travel provision while exercising certain functions under the Highways Act 1980.
- S.9(2) Duty to have regard to the needs of walkers and cyclists while exercising certain traffic management functions.
- S.10(1) Duty to exercise functions under this Act in a way that promotes active travel and secures more active travel infrastructure.
- S.10(2) Duty to make a report on Welsh Ministers on what the local authority has done to meet their duty under s.10(1).

Powers of Welsh Ministers

- S.2(4) Power to make a Direction on designated localities.
- S.2(6) Power to issue guidance on whether a route is appropriate for active travel.
- S.2(9) Power to issue guidance on related facilities.
- S.3(4) Power to issue guidance on preparing and consulting on the existing route map*.
- S.3(5) Power to vary timescales for the submission of the existing route map by direction.
- S.3(8) Power to require local authority to revise and resubmit an existing routes map if they decide not to approve it.
- S.3(5) Power to issue guidance on preparing and consulting on the integrated etwork map.
- S.4(6)(b)) Power to vary timescales for the submission of the integrated network map by direction.
- S.4(7) Power to require local authority to revise and resubmit an integrated network map if they decide not to approve it.
- S.4(10) Power to vary timescales for the submission of the integrated network map by direction.
- S.5(2) Power to issue guidance on publishing the maps. S.7(2) – power to issue guidance on continuous improvement.
- S.12(1) Power to vary or revoke guidance and directions issued under this Act.
- S.14 Power to commence Act by Order.

Duties of Welsh Ministers

- S.3(9) Duty to consider certain factors in deciding whether to approve the existing routes maps.
- S.4(8) Duty to consider certain factors in deciding whether to approve the integrated network maps.
- S.8 Duty to make and publish annual reports on extent of active travel journeys in Wales.
- S.9(1) Duty to take reasonable steps to enhance active travel provision while exercising certain functions under the Highways Act 1980.

- S.9(2) Duty to have regard to the needs of walkers and cyclists while exercising certain traffic management functions.
- S.10(1) Duty to exercise functions under this Act in a way that promotes active travel and secures more active travel infrastructure.
- S.11 Duty to make full review of the Act 5 years after the publication of the first integrated network map.
- S.12(2) Duty to have regard to the desirability of active travel when varying or revoking direction and guidance.

Appendix B

Direction designating localities under the Active Travel Act

Active Travel (Wales) Act 2013

To all county and county borough councils in Wales

Direction designating localities in relation to active travel routes

The Welsh Ministers, in exercise of the powers conferred on them by section 2(4) and (5) of the Active Travel (Wales) Act 2013 (“the Act”), make the following Direction.

Statutory background

Section 2(1) of the Act provides that for the purposes of the Act a route in a local authority’s area is an active travel route if:

- a. a) the route is situated in a designated locality in the area
- b. b) the local authority considers that it is appropriate for it to be regarded as an active travel route
- c. Section 2(4) of the Act provides that, in the Act, “designated”, in relation to a locality, means specified, or of a description specified, in a direction given by the Welsh Ministers
- d. Section 2(5) provides that the Welsh Ministers may, in particular, specify a locality, or description of a locality, by reference to:
 - e. a) density of the population
 - f. b) size
 - g. c) proximity to densely populated localities above a particular size
 - h. d) position between such localities
 - i. e) proximity to community services and facilities
 - j. f) potential for other reasons to be a locality, or a description of locality, in which more travel is undertaken by walkers and cyclists by active travel journeys

The direction

In exercise of the above powers under the act, the Welsh Ministers direct that the designated localities for the purposes of the act are those localities within Wales specified in the schedule below under the heading 'designated locality'. The table below sets out which cities, towns and villages are included in the designated locality (where the designated locality covers multiple settlements), the population of the designated locality, and the local authorities with responsibility for that designated locality. Shaded blue indicates that the designated localities run across local authority boundaries, shaded yellow means they fall within a single local authority area.

The designated localities are derived from the Office for National Statistics' Built Up Areas. The Built-Up Areas are identified by splitting Wales into 50 metre by 50 metre squares. The predominant land use in each square is identified as either built up or not built up (containing buildings and similar infrastructure, or empty of development). Where built up squares sit next to each other, then they are amalgamated into larger built up areas.

If settlements are within 200 metres of each other, then they were linked together into a single 'Built Up Area'. Many of these Built Up Areas are amalgamations of a number of towns and villages, which are in close proximity to each other and/or to a larger densely populated area. This approach reflects the actual pattern of development, rather than the administrative boundary divisions between settlements.

The designated localities have been named with reference to the largest town or city within the locality, but many stretch beyond the administrative boundaries of that named town or city. Where the shaded areas on the map extend beyond the administrative boundaries of the named town or city, local authorities should follow the boundaries shaded on the map.

The determination of 'Built Up Areas' derives from 2011 census data and it is anticipated that once the 2021 census results are published a recalculation of built up areas will be undertaken and a new list will be published.

Local authorities are not required to include on their ATNM areas in England adjacent to their boundaries.

Designated locality	Settlements that are included in the designated locality	Population	Local Authority with responsibility for settlements within the designated locality
Cardiff		447,287	Caerphilly County Borough Council, The City of Cardiff Council, Vale of Glamorgan Council, Rhondda Cynon Taf County Borough Council
	Caerphilly	41,402	Caerphilly County Borough Council
	Cardiff	335,145	The City of Cardiff Council
	Dinas Powys	7,490	Vale of Glamorgan Council
	Penarth	27,226	Vale of Glamorgan Council
	Pontypridd	30,457	Rhondda Cynon Taf County Borough Council
	Taff's Well	5,567	The City of Cardiff Council and Rhondda Cynon Taf County Borough Council
Newport		306,844	Caerphilly County Borough Council, Torfaen County Borough Council and Newport City Council
	Aberbargoed	994	Caerphilly County Borough Council
	Abercarn	5,352	Caerphilly County Borough Council
	Abersychan	7,573	Torfaen County Borough Council
	Bargoed	11,537	Caerphilly County Borough Council
	Blackwood	24,042	Caerphilly County Borough Council
	Cwmbran	46,915	Torfaen County Borough Council

Designated locality	Settlements that are included in the designated locality	Population	Local Authority with responsibility for settlements within the designated locality
	Newbridge	9,590	Caerphilly County Borough Council
	Newport	128,060	Newport City Council
	Pontllanfraith	9,220	Caerphilly County Borough Council
	Pontypool	28,334	Torfaen County Borough Council
	Risca	14,958	Caerphilly County Borough Council
	Wattsville	1,065	Caerphilly County Borough Council
	Ystrad Mynach	19,204	Caerphilly County Borough Council
Swansea		300,352	City and County of Swansea Council, Neath Port Talbot County Borough Council, Powys County Council
	Glais	838	City and County of Swansea Council
	Gowerton	8,183	City and County of Swansea Council
	Neath	50,658	Neath Port Talbot County Borough Council
	Pontardawe	12,333	Neath Port Talbot County Borough Council
	Port Talbot	37,276	Neath Port Talbot County Borough Council
	Swansea	179,485	City and County of Swansea Council
	Upper Killay	1,331	City and County of Swansea Council
	Ystradgynlais	10,248	Powys County Council
Wrexham		65,692	Wrexham County Borough Council
	Bradley	1,323	Wrexham County Borough Council

Designated locality	Settlements that are included in the designated locality	Population	Local Authority with responsibility for settlements within the designated locality
	Rhostyllen	2,766	Wrexham County Borough Council
	Wrexham	61,603	Wrexham County Borough Council
Buckley		63,576	Flintshire County Council
	Buckley	19,639	Flintshire County Council
	Connah's Quay	16,774	Flintshire County Council
	Deeside Industrial Park	2,134	Flintshire County Council
	Northop Hall	1,530	Flintshire County Council
	Sandycroft	6,724	Flintshire County Council
	Shotton	16,775	Flintshire County Council
Tonypandy		62,545	Rhondda Cynon Taf County Borough Council
	Porth	14,648	Rhondda Cynon Taf County Borough Council
	Rhondda	13,333	Rhondda Cynon Taf County Borough Council
	Tonypandy	17,789	Rhondda Cynon Taf County Borough Council
	Treherbert	5,440	Rhondda Cynon Taf County Borough Council
	Treorchy	7,694	Rhondda Cynon Taf County Borough Council
	Tylorstown	3,641	Rhondda Cynon Taf County Borough Council
Bridgend		58,380	Bridgend County Borough Council
	Bridgend	46,757	Bridgend County Borough Council
	Sarn	10,805	Bridgend County Borough Council
	Trelales	818	Bridgend County Borough Council
Barry		54,673	Vale of Glamorgan Council

Designated locality	Settlements that are included in the designated locality	Population	Local Authority with responsibility for settlements within the designated locality
Llanelli		49,591	Carmarthenshire County Council
	Llanelli	43,878	Carmarthenshire County Council
	Llangennech	4,324	Carmarthenshire County Council
	Pwll	1,389	Carmarthenshire County Council
Rhyl/Prestatyn		46,267	Denbighshire County Council
	Dyserth	2,269	Denbighshire County Council
	Meliden	2,066	Denbighshire County Council
	Prestatyn	16,783	Denbighshire County Council
	Rhyl	25,149	Denbighshire County Council
Merthyr Tydfil		43,820	Merthyr Tydfil County Borough Council
Colwyn Bay		34,284	Conwy County Borough Council
	Colwyn Bay	29,405	Conwy County Borough Council
	Penrhyn Bay	4,432	Conwy County Borough Council
	Penrhyn-side	447	Conwy County Borough Council
Ebbw Vale		33,068	Blaenau Gwent County Borough Council
	Blaina	4,808	Blaenau Gwent County Borough Council
	Brynmawr	5,530	Blaenau Gwent County Borough Council
	Ebbw Vale	18,095	Blaenau Gwent County Borough Council
	Nantyglo	4,635	Blaenau Gwent County Borough Council

Designated locality	Settlements that are included in the designated locality	Population	Local Authority with responsibility for settlements within the designated locality
Aberdare		31,135	Rhondda Cynon Taf County Borough Council
	Aberdare	29,748	Rhondda Cynon Taf County Borough Council
	Fernhill	1,387	Rhondda Cynon Taf County Borough Council
Flint		26,442	Flintshire County Council
	Flint	14,907	Flintshire County Council
	Gorsedd	391	Flintshire County Council
	Holywell	9,808	Flintshire County Council
	Walwen	1,336	Flintshire County Council
Rhosllanerchrugog		25,362	Wrexham County Borough Council and Denbighshire County Council
	Cefn-mawr	7,051	Wrexham County Borough Council
	Rhosllanerchrugog	13,501	Wrexham County Borough Council
	Ruabon	3,357	Wrexham County Borough Council
	Trevor	1,453	Wrexham County Borough Council and Denbighshire County Council
Ammanford		23,709	Carmarthenshire County Council
	Ammanford	7,945	Carmarthenshire County Council
	Pen-y-groes	5,717	Carmarthenshire County Council
	Penybanc	1,126	Carmarthenshire County Council
	Saron	867	Carmarthenshire County Council

Designated locality	Settlements that are included in the designated locality	Population	Local Authority with responsibility for settlements within the designated locality
	Tumble	4,302	Carmarthenshire County Council
	Tycroes	3,752	Carmarthenshire County Council
Church Village		23,277	Rhondda Cynon Taf County Borough Council
	Beddau	8,236	Rhondda Cynon Taf County Borough Council
	Church Village	13,783	Rhondda Cynon Taf County Borough Council
	Efail Isaf	1,258	Rhondda Cynon Taf County Borough Council
Maesteg		21,001	Neath Port Talbot County Borough Council and Bridgend County Borough Council
	Croeserw	1,569	Neath Port Talbot County Borough Council and Bridgend County Borough Council
	Cymmer	544	Neath Port Talbot County Borough Council
	Maesteg	18,888	Bridgend County Borough Council
Gorseinon		20,581	City and County of Swansea Council
	Gorseinon	15,757	City and County of Swansea Council
	Loughor	4,824	City and County of Swansea Council
Aberystwyth		18,749	Ceredigion County Council
	Aberystwyth	18,093	Ceredigion County Council
	Llanbadarn Fawr	656	Ceredigion County Council

Designated locality	Settlements that are included in the designated locality	Population	Local Authority with responsibility for settlements within the designated locality
Kinmel Bay/Abergele		18,705	Conwy County Borough Council
	Abergele	9,208	Conwy County Borough Council
	Kinmel Bay	9,497	Conwy County Borough Council
Bangor		17,988	Gwynedd Council
Chepstow		16,169	Monmouthshire County Council
Carmarthen		15,854	Carmarthenshire County Council
Porthcawl		15,672	Bridgend County Borough Council
Llandudno		15,371	Conwy County Borough Council
Tredegar		14,855	Blaenau Gwent County Borough Council
Abergavenny		14,651	Monmouthshire County Council
	Abergavenny	13,423	Monmouthshire County Council
	Llanfoist	1,228	Monmouthshire County Council
Haverfordwest		14,596	Pembrokeshire County Council
Llantrisant		14,422	Rhondda Cynon Taf County Borough Council
	Brynsadler	1,158	Rhondda Cynon Taf County Borough Council
	Llantrisant	13,264	Rhondda Cynon Taf County Borough Council
Llantwit Major		14,384	Vale of Glamorgan Council
	Llanmaes	403	Vale of Glamorgan Council
	Llantwit Major	8,427	Vale of Glamorgan Council

Designated locality	Settlements that are included in the designated locality	Population	Local Authority with responsibility for settlements within the designated locality
Pyle		13,701	Bridgend County Borough Council
Milford Haven		13,582	Pembrokeshire County Council
Treharris		12,352	Merthyr Tydfil County Borough Council and Caerphilly County Borough Council
	Nelson	4,647	Caerphilly County Borough Council
	Treharris	7,705	Merthyr Tydfil County Borough Council
Holyhead		11,431	Isle of Anglesey County Council
Newtown		11,357	Powys County Council
Mountain Ash		11,230	Rhondda Cynon Taf County Borough Council
Caldicot		11,200	Monmouthshire County Council
Llandudno Junction		11,109	Conwy County Borough Council
	Bryn Pydew	451	Conwy County Borough Council
	Llandudno Junction	10,658	Conwy County Borough Council
Abertillery		10,946	Blaenau Gwent County Borough Council
Monmouth		10,110	Monmouthshire County Council
Mold		10,058	Flintshire County Council
Pembroke Dock		9,753	Pembrokeshire County Council
Caernarfon		9,730	Gwynedd Council
	Caethro	237	Gwynedd Council
	Caernarfon	9,493	Gwynedd Council

Designated locality	Settlements that are included in the designated locality	Population	Local Authority with responsibility for settlements within the designated locality
Tonyrefail		9,317	Rhondda Cynon Taf County Borough Council
Pencoed		9,166	Bridgend County Borough Council
Pontarddulais		9,073	City and County of Swansea Council and Carmarthenshire County Council
Caerleon		8,747	Newport City Council and Torfaen County Borough Council
Rhymney		8,537	Caerphilly County Borough Council
	Pontlottyn	1,924	Caerphilly County Borough Council
	Rhymney	5,151	Caerphilly County Borough Council
Denbigh		8,514	Denbighshire County Council
Burry Port		8,310	Carmarthenshire County Council
	Burry Port	6,156	Carmarthenshire County Council
	Pembrey	2,154	Carmarthenshire County Council
Brecon		8,250	Powys County Council
Pembroke		7,552	Pembrokeshire County Council
Ferndale		7,338	Rhondda Cynon Taf County Borough Council
Hirwaun		7,247	Rhondda Cynon Taf County Borough Council
Brynna/Llanharan		6,686	Rhondda Cynon Taf County Borough Council

Designated locality	Settlements that are included in the designated locality	Population	Local Authority with responsibility for settlements within the designated locality
Abertridwr		6,504	Caerphilly County Borough Council
Rhoose		6,160	Vale of Glamorgan Council
Abercynon		5,983	Rhondda Cynon Taf County Borough Council
Broughton		5,974	Flintshire County Council
Welshpool		5,948	Powys County Council
Undy/Magor		5,914	Monmouthshire County Council
Coedpoeth		5,723	Wrexham County Borough Council
Gwaun-Cae- Gurwen/ Brynamman		5,692	Neath Port Talbot County Borough Council and Carmarthenshire County Council
	Brynamman	2,608	Carmarthenshire County Council and Neath Port Talbot County Borough Council
	Gwaun-Cae-Gurwen	3,084	Neath Port Talbot County Borough Council and Carmarthenshire County Council
Blaenavon		5,647	Torfaen County Borough Council
Ogmore Vale/ Nant-y- moel		5,461	Bridgend County Borough Council
	Nant-y-moel	2,344	Bridgend County Borough Council
	Ogmore Vale	3,117	Bridgend County Borough Council
Ruthin		5,461	Denbighshire County Council

Designated locality	Settlements that are included in the designated locality	Population	Local Authority with responsibility for settlements within the designated locality
Glynneath		5,419	Neath Port Talbot County Borough Council
	Blaengwrach	1,141	Neath Port Talbot County Borough Council
	Glynneath	4,278	Neath Port Talbot County Borough Council
Cwmavon		5,336	Neath Port Talbot County Borough Council
Llandrindod Wells		5,309	Powys County Council
Cardigan		5,301	Pembrokeshire County Council and Ceredigion County Council
	Cardigan	4,184	Ceredigion County Council
	St Dogmaels	1,117	Pembrokeshire County Council
Gresford		5,010	Wrexham County Borough Council
Menai Bridge		4,958	Isle of Anglesey County Council
Llangefni		4,864	Isle of Anglesey County Council
Bethesda		4,735	Gwynedd Council
	Bethesda	3,799	Gwynedd Council
	Rachub	936	Gwynedd Council
Hope		4,706	Flintshire County Council and Wrexham County Borough Council
	Hope	4,284	Flintshire County Council
	Sydallt	422	Wrexham County Borough Council
Tenby		4,696	Pembrokeshire County Council
Llay		4,681	Wrexham County Borough Council

Designated locality	Settlements that are included in the designated locality	Population	Local Authority with responsibility for settlements within the designated locality
Hendreforgan/ Gilfach Goch		4,395	Rhondda Cynon Taf County Borough Council and Bridgend County Borough Council
	Gilfach Goch	1,920	Rhondda Cynon Taf County Borough Council and Bridgend County Borough Council
	Hendreforgan	2,475	Rhondda Cynon Taf County Borough Council
Glanaman		4,384	Carmarthenshire County Council and Neath Port Talbot County Borough Council
Pontycymer		4,288	Bridgend County Borough Council
New Tredegar		4,208	Caerphilly County Borough Council
Pwllheli		4,076	Gwynedd Council
Glyncoch		4,020	Rhondda Cynon Taf County Borough Council
Chirk		4,007	Wrexham County Borough Council
Conwy		3,873	Conwy County Borough Council
Cowbridge		3,804	Vale of Glamorgan Council
Llanbradach		3,746	Caerphilly County Borough Council
Rhuddlan		3,709	Denbighshire County Council
Neyland		3,708	Pembrokeshire County Council
Blaenau Ffestiniog		3,662	Gwynedd Council
Llanfairfechan		3,637	Conwy County Borough Council

Designated locality	Settlements that are included in the designated locality	Population	Local Authority with responsibility for settlements within the designated locality
Penyffordd		3,554	Flintshire County Council
Aberfan		3,547	Merthyr Tydfil County Borough Council
Ynysybwl		3,503	Rhondda Cynon Taf County Borough Council
Murton		3,500	City and County of Swansea Council
Llangollen		3,466	Denbighshire County Council
Fishguard		3,419	Pembrokeshire County Council
Saundersfoot		3,361	Pembrokeshire County Council
	New Hedges	594	Pembrokeshire County Council
	Saundersfoot	2,767	Pembrokeshire County Council
St Asaph		3,355	Denbighshire County Council
Llanrwst		3,323	Conwy County Borough Council
Amlwch		3,211	Isle of Anglesey County Council
Llanfair Pwllgwyngyll		3,107	Isle of Anglesey County Council
Tywyn		3,097	Gwynedd Council
Marshfield		3,054	Newport City Council
	Castleton	735	Newport City Council
	Marshfield	2,319	Newport City Council
Llanharry		3,035	Rhondda Cynon Taf County Borough Council and Vale of Glamorgan Council
Knighton		3,007	Powys County Council

Designated locality	Settlements that are included in the designated locality	Population	Local Authority with responsibility for settlements within the designated locality
Llanhilleth		2,990	Blaenau Gwent County Borough Council and Caerphilly County Borough Council
Porthmadog		2,981	Gwynedd Council
Lampeter		2,970	Ceredigion County Council
Llanidloes		2,929	Powys County Council
Usk		2,834	Monmouthshire County Council
Builth Wells/ Llanelwedd		2,829	Powys County Council
Llandybie		2,813	Carmarthenshire County Council
Kidwelly		2,782	Carmarthenshire County Council
Cwm		2,739	Blaenau Gwent County Borough Council
Dolgellau		2,688	Gwynedd Council
Llanddulas/ Mynydd Marian		2,674	Conwy County Borough Council
	Llanddulas	1,268	Conwy County Borough Council
	Llysfaen	330	Conwy County Borough Council
	Mynydd Marian	1,076	Conwy County Borough Council
St Clears		2,663	Carmarthenshire County Council
	Pwll-trap	674	Carmarthenshire County Council
	St Clears	1,989	Carmarthenshire County Council
Penmaenmawr		2,535	Conwy County Borough Council
Creigiau		2,380	The City of Cardiff Council

Designated locality	Settlements that are included in the designated locality	Population	Local Authority with responsibility for settlements within the designated locality
Machen		2,362	Caerphilly County Borough Council
Valley		2,361	Isle of Anglesey County Council
Cwmfelinfach/ Ynysddu		2,342	Caerphilly County Borough Council
	Cwmfelinfach	1,383	Caerphilly County Borough Council
	Ynysddu	959	Caerphilly County Borough Council
Barmouth		2,315	Gwynedd Council
Pentyrch		2,287	The City of Cardiff Council
Y Felinheli		2,284	Gwynedd Council
Leeswood		2,282	Flintshire County Council
Rossett		2,279	Wrexham County Borough Council
Narberth		2,265	Pembrokeshire County Council
Gilwern		2,263	Monmouthshire County Council
Bettws		2,253	Newport City Council
Benllech		2,236	Isle of Anglesey County Council
Machynlleth		2,235	Powys County Council
Seven Sisters		2,123	Neath Port Talbot County Borough Council
Tanyfron		2,090	Wrexham County Borough Council
Resolven		2,068	Neath Port Talbot County Borough Council
Llandovery		2,065	Carmarthenshire County Council

Designated locality	Settlements that are included in the designated locality	Population	Local Authority with responsibility for settlements within the designated locality
Crickhowell		2,063	Powys County Council
Presteigne		2,056	Powys County Council
Southgate		2,004	City and County of Swansea Council

Appendix C

We are grateful to Sustrans Cymru and Ceredigion County Council for permission to reproduce this map.

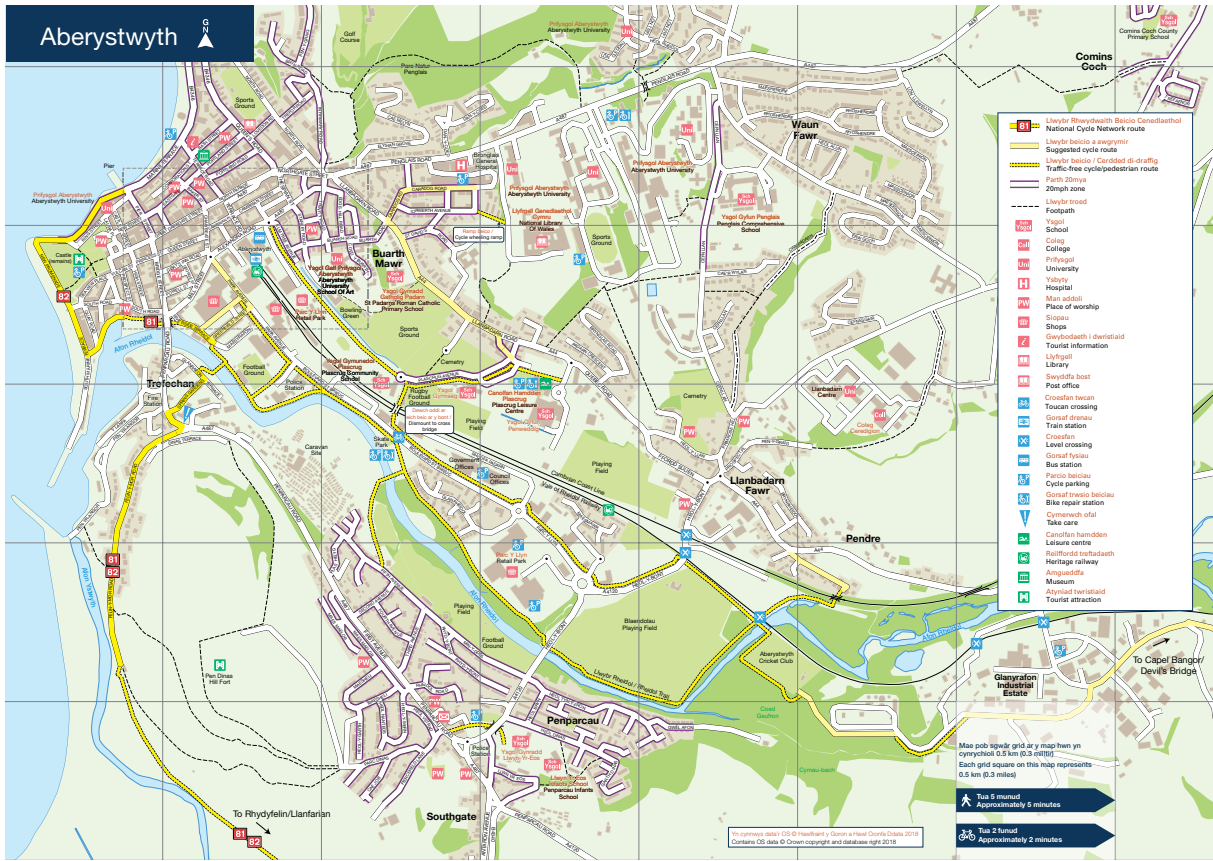



Sustrans
JOIN THE MOVEMENT

Sustrans yw'r eusen sy'n galluogi pobl i deithio ar droed, beic neu drwmwrthol gyhoeddus ar gyfer rhagor o'r swmleuol a wnaeth bob dydd. Mae ein gwaith yn ei gwneud hi'n bosibl i bobl ddechrau swmleuol iachach, glanach a thabach gyda gwell lleoedd a gollodau i ymud drwyddyn a byw ynddyn.

Mae'n bryd i ni gyd wneud dewisiadau gwell yn y ffordd yr ydych chi yrru. Cymweryd y cam a chefnogoch Sustrans heddiw.

Sustrans is the charity that's enabling people to travel by foot, bike or public transport for more of the journey we make every day. Our work makes it possible for people to choose healthier, cleaner and cheaper journeys, with better places and spaces to move through and live in.

It's time we all began making smarter travel choices. Make your move and support Sustrans today.

www.sustrans.org.uk
0845 113 0065
www.facebook.com/sustrans.cymru
@sustranscymru



Canol y Dref / Town Centre



Cysylltu eich siwrnai

Cerdded a beicio
Ceredigion. Am ragor o fanylion am deithio lleol a llybrau beicio yng Ngheredigion, ewch i www.ceredigion.gov.uk/preswylwr/teithio-hydd-a-pharcio/teithio-lesol/

Sustrans. Porwch, lawrwythwch a chreu mapiau ar-lein o lybrau cerdded a beicio lleol. Gallwch hefyd bloto eich siwrnai er mwyn ei rhannu gyda ffrindiau a theulu. www.sustrans.org.uk/maps Ffôn: 0845 113 0065

Dawch i darganfod y gorau o'r Ffrwydwrthol Beicio Cenedlaethol yng Nghymru ar ein gwefan: www.sustrans.org.uk/wales/routes

Am ragor o fanylion am lybrau cerdded a beicio yn Aberystwyth: www.sustrans.org.uk/wales/national-cycle-network/free-leaflets-and-maps

Tŷn a bws

I gael gwybodaeth teithio cysylltwch â Traveline Cymru, y gwasanaeth gwybodaeth trafniadaeth gyhoeddus ar gyfer Cymru. Ewch i www.traveline.cymru neu ffonwch 0800 464 00 00 i gael manylion am wasanaethau bws, coets a z.

Rhesymau da dros deithio o gwmpas ar droed, beic, bws neu drên

Er budd eich iechyd a'ch lles
Mae cerdded a beicio i'w gwneud. I'r siopau neu i ymweld â ffrindiau a theulu yn fynd i'w ardorhol i gynnwys gweithgareddi corfforol rheolaidd yn eich arferion bob dydd. Gall llyn eich cynorthwyo i logi caloriau, llesau colosterol a gwasgwyrdd gwedd. Mae gweithgareddi corfforol rheolaidd hefyd yn gwella eich hwylyau, eich teimlad o les a gall cynorthwyo i roi hwb i'ch hunan-barch.

Ar y bws neu'r tŷn, fe gewch amser i fwyhau'r daith - gwrando ar gerddoniaeth, ymgoli mewn llyfr da neu sgwrsio - a thrwy roi gortwys i'ch cerbyd gallwch arbed arian hefyd.

Er budd yr amgylchedd
Drwy fynd ar y tŷn neu'r bws rydych chi'n lleihau eich allyriadau carbon gan rhwng chwech ac wyth gwaith o gymharu â mynd mewn car. Yn well byth, nid yw cerdded a beicio yn cynhyrchu allyriadau carbon. Mae i'w gael ar y ffordd hefyd yn golygu amgylchedd mwy dogel, yn arbennig ar gyfer plant, a lle mwy dymunol i'w bawb chonm.

Er mwyn arbed arian
Un o fantillion teithio o gwmpas o dan eich grym eich hun yw ei fod yn eiddad o rad. Dim treth car, dim MOT a dim gollidau am bws petrol. Os byddwch yn cerdded neu'n beicio'n rheolaidd fe arbedwch ffortwyl!

Good reasons to get around by foot, bike, bus or train

For your health and well-being
Walking and cycling to work, the shops, or to visit friends and family are great ways to fit regular physical activity into your daily routine. This can help you burn calories, reduce cholesterol and lower blood pressure. Regular physical activity also improves your mood, your sense of well-being and can help boost self-esteem.

On the bus or train, you'll have time to enjoy the journey – listen to music, read a good book or have a chat – and by giving your vehicle a well deserved rest, you can save money too!

For the environment
By taking a train or bus you reduce your carbon emissions by between six and eight times compared to going by car. Even better, walking and cycling do not produce any carbon emissions. Fewer cars on the road also mean a safer environment, particularly for children, and a more pleasant place for us all.

For saving money
One of the things about getting around under your own steam is that it's really cheap. No car tax, no MOT and no petrol price worries. If you walk or cycle regularly you'll save a fortune!

Appendix D

Model engagement report

This report must be submitted to Welsh Government with the authority's draft ATNM. An electronic version of the report can be downloaded from: <https://gov.wales/active-travel-guidance-model-engagement-report-appendix-d> If the information is held in a different format that may be submitted instead of using this form.

In total, how many engagement events did you organise?	How many people attended?
How were the events advertised?	
Have you established a group with which you engage in regular discussion on active travel issues including network planning? If yes, please give a brief description.	

Engagement with specific categories of the population

For each category please give a brief description of how the engagement took place how many people were involved, the names of organisations involved and at which stage of the process the engagement occurred (e.g. regular, ongoing engagement; pre-draft ATNM; formal consultation period).

Category engaged with	Number of people engaged	Organisations involved	Stage of the process
People who do not currently travel actively			
Description of the engagement			

Category engaged with	Number of people engaged	Organisations involved	Stage of the process
Blind and partially sighted people and their organisations			
Description of the engagement			
Other local authority departments and adjoining local authorities			
Description of the engagement			
Young People (including school students)			
Description of the engagement			
People who had requested that they be consulted			
Description of the engagement			
Walking and cycling organisations			
Description of the engagement			
Town and Community Councils (where present)			
Description of the engagement			

Category engaged with	Number of people engaged	Organisations involved	Stage of the process
Other public bodies, including health organisations			
Description of the engagement			
Elected members			
Description of the engagement			
Others (e.g. large employers or other stakeholders)			
Description of the engagement			

Name of local authority:			
Contact official:		Date submitted:	

Note: Consultation on the ATNM does not replace any statutory requirements for consultation and engagement that is required as part of an individual scheme.

Appendix E

The following plans provide examples of ATNMs from different local authorities, as follows;

Bridgend – an example of an approved ATNM from the 2017 submission.

Abergavenny – draft ATNM at the statutory consultation stage June 2020. Map taken from DataMapWales.

Bridgend Town Active Travel Network Plan (Scale 1:14,000)

Produced by the Active Travel web site. Gynhyrchwyd gan y wefan Teithio Llesol.

Bridgend County Borough Council
Civic Offices
Angel Street
Bridgend, CF31 4WB

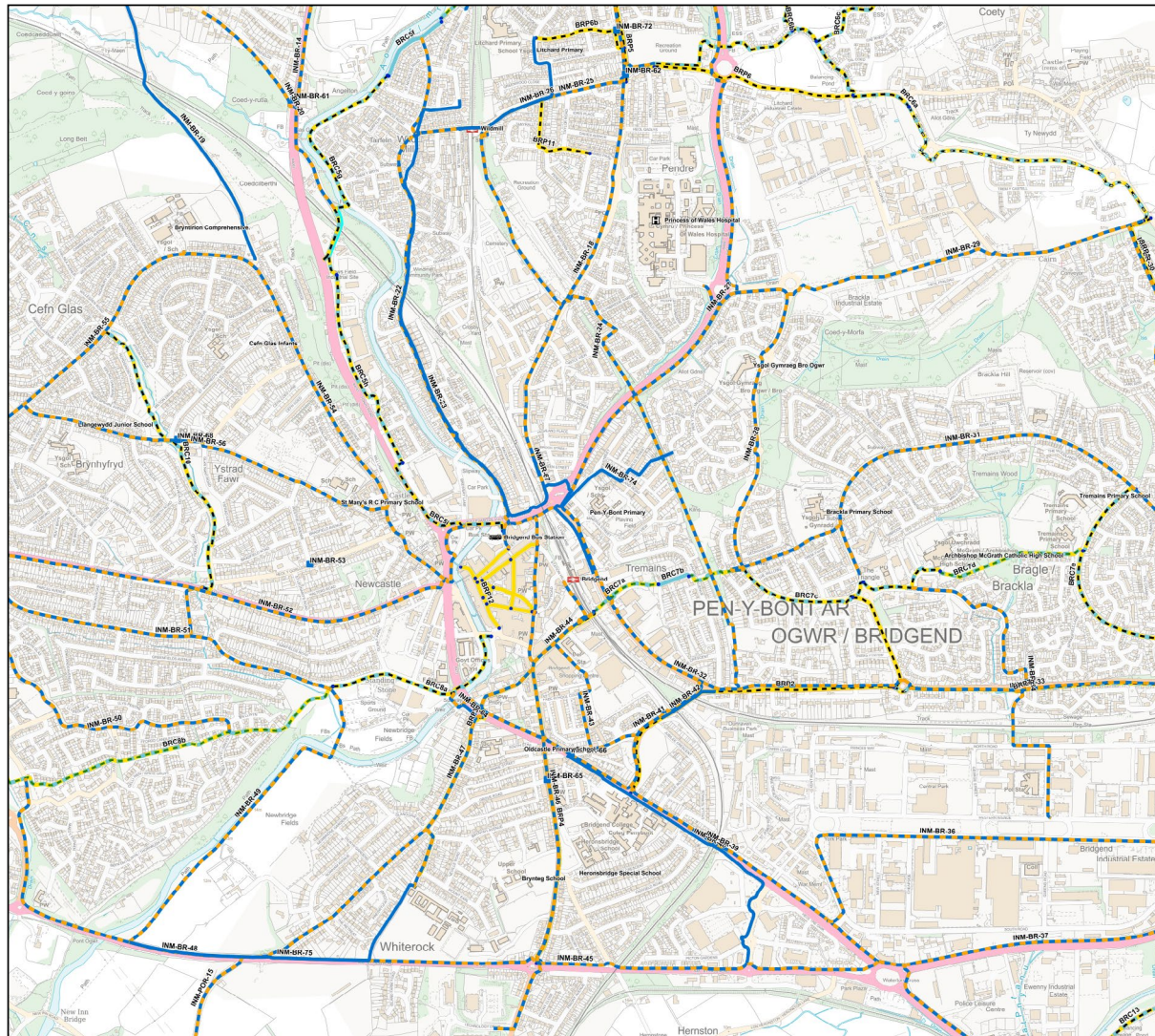

Legend / Eglurhad

Active Travel Routes / Llwybrau Teithio Llesol

- Undefined path design / Dyluniad llwybr heb ei ddiffinio
- Footpath (away from road) / Llwybr troed (i ffwrdd o'r ffordd)
- Footway (alongside road) / Troedffordd (ochr yn ochr â ffordd)
- Cycle track (away from road) / Trac beicio (i ffwrdd o'r ffordd)
- Cycle track (alongside road) / Trac beicio (ochr yn ochr â ffordd)
- Shared use foot/cycle path (away from road) / Llwybr cerdded/beicio a rennir (i ffwrdd o'r ffordd)
- Shared use foot/cycle path (alongside road) / Llwybr cerdded/beicio a rennir (ochr yn ochr â ffordd)
- Segregated foot/cycle path (away from road) / Llwybr cerdded/beicio wedi'i wahanu (i ffwrdd o'r ffordd)
- Segregated foot/cycle path (alongside road) / Llwybr cerdded/beicio wedi'i wahanu (ochr yn ochr â ffordd)
- Cycle route (on road, not segregated) / Lôn feicio (ar y ffordd, heb ei gwahanu)
- Cycle lane (on road, segregated) / Lôn feicio (ar y ffordd, wedi'i gwahanu)
- Pedestrian zone / Ardal cerdded
- Pedestrian and cycle zone / Ardal cerdded a beicio
- Road without footway / Ffordd heb droedffordd

Line end points / Pwyntiau diwedd llinell

Integrated Network Walking

Integrated Network Cycling

Integrated Network Shared Use

Cycle Network / Rhwydwaith Beicio

Landmarks / Tirodau

Bus Station / Gorsaf Fysus

Hospital / Ysbyty

Railway Station / Gorsaf Reilffordd

Schools / Ysgolion

Labels / Labeli

© Crown Copyright and database right 2014. Ordnance Survey 100021874. Welsh Government. © Hawlfraint a hawliau cronfa ddata'r Goron 2014. Rhif Trwydded yr Arolwg Ordnans 100021874. Whilst the Welsh Government have made every effort to ensure that the information on this website is accurate and up-to-date, the Welsh Government takes no responsibility for any incorrect information. The data is compiled from Public Rights of Way, Ordnance Survey ITN, Ordnance Survey ITN Urban Path and aerial photography derived data supplemented by field survey. The online map is provided for guidance only and is not a legal record. Er bod Llywodraeth Cymru wedi gwneud pob ymdrech i sicrhau bod y wybodaeth ar y wefan hon yn gywir ac yn gyfredol, mae Llywodraeth Cymru yn cymryd unrhyw gyfrifoldeb am unrhyw wybodaeth anghywir. Lluniwyd y data o hawliau tramwy cyhoeddus, Rhti yr AO, Llwybrau Trefol Rhti yr AO a data sy'n deillio o ffotograffau o'r awyr wedi'i ategu gan arolwg maes. Yn y map ar-lein yn darparu canllaw yn unig ac nid yw cofnod cyfreithiol.





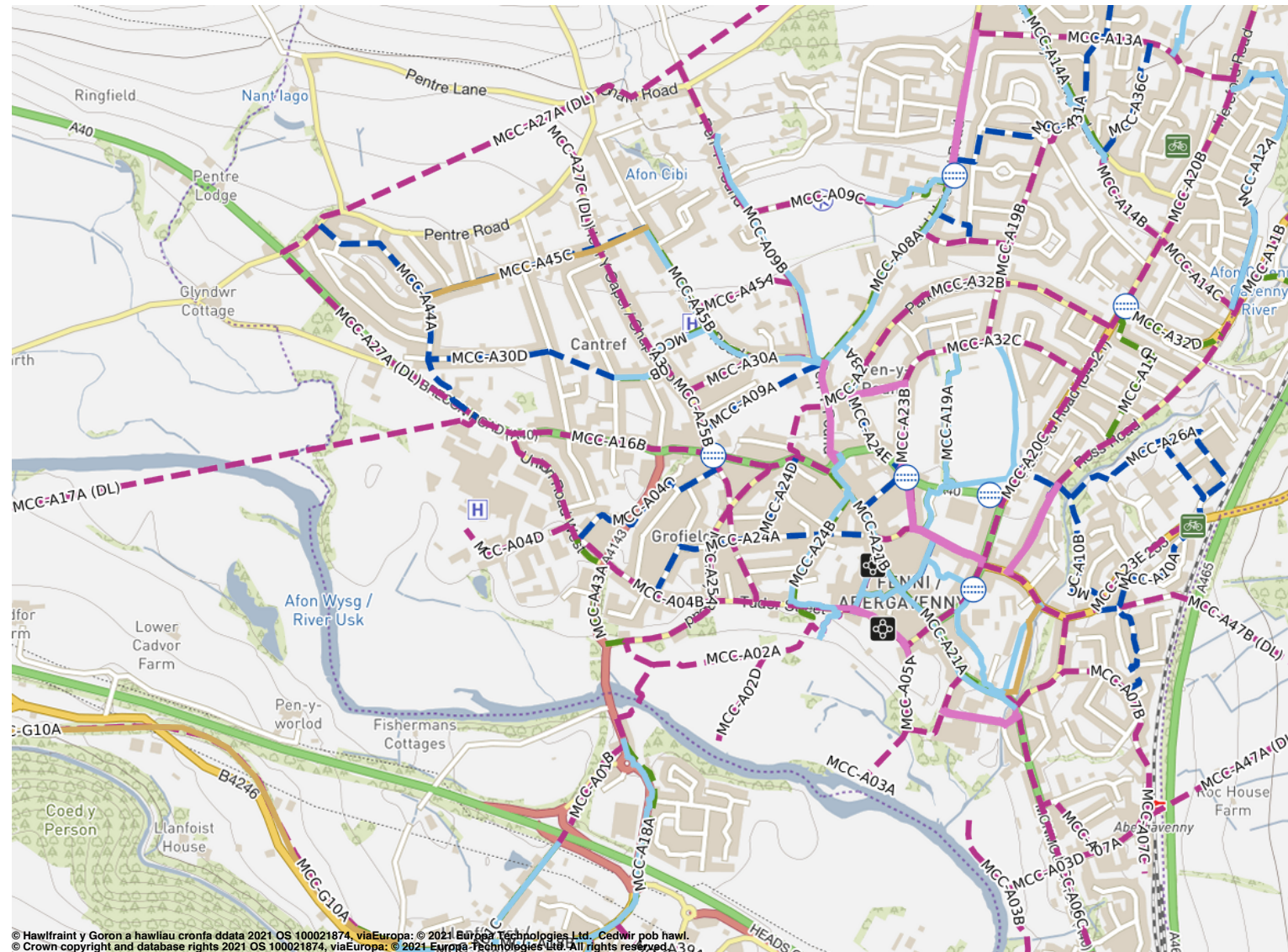

Abergavenny - DRAFT Active Travel Network Map - June 2021



Future Routes

-  Walking
-  Cycling
-  Shared Use
-  Other

Existing Routes

-  Walking
-  Cycling
-  Shared Use
-  Other

Related Facilities

-  Related Facilities

Crossing

-  Crossing

Advanced Stop Line

-  Advanced Stop Line

© Hawlfraint y Goron a hawliau cronfa ddata 2021 OS 100021874, viaEuropa. © 2021 Europa Technologies Ltd. Cedwir pob hawl.
 © Crown copyright and database rights 2021 OS 100021874, viaEuropa. © 2021 Europa Technologies Ltd. All rights reserved. A394

Appendix F

Annual report

To the Welsh Ministers,

Active Travel (Wales) Act 2013 Reporting Duties

In accordance with the duties under sections 7 (3) and 10 (2) of the Active Travel (Wales) Act 2013, please find [insert LA name]'s annual report for the year [insert year].

The actions taken to promote active travel journeys	[insert actions taken by the various local authority departments; such as information provision, work undertaken with schools and other organisations, signage, active travel challenges and competitions, events, etc]
The actions taken to secure new active travel routes and related facilities and improvements	[insert actions taken by the various local authority departments; such as directly funded or grant funded construction and improvement of routes and facilities, those negotiated as part of planning processes, support given to third parties, etc]
Costs incurred for new active travel routes and facilities and improvements of existing active travel routes and related facilities carried out in the preceding full financial year	[insert spend]

In addition to the above, the following information provides an overview of infrastructure that has been implemented during the previous year:

Indicative spending for new active travel routes and facilities and improvements of existing active travel routes and related facilities funded or part funded by third parties.	[insert indicative spend and source of funding]
Length of new routes: <ul style="list-style-type: none"> - Walking - Cycling - Shared Use 	[insert length (in metres) of new walking, cycling and shared-use routes]

Length of improved routes: - Walking - Cycling - Shared Use	[insert length (in metres) of improved walking, cycling and shared-use routes]
New and improved active travel facilities	insert number and type of new and improved active travel facilities, for example cycle parking, toilets, seating along active travel routes]

Additional information (optional)

I confirm that this report will be published online and made available in hard copy on request, in accordance with the statutory Active Travel Act Guidance (2021 edition).

Chief Executive Signature:

Chief Executive Name:

Date of submission to Welsh Ministers:

Report to accompany the ATNM submission

The data available will vary between authorities; therefore the template gives examples for the type of data that can be used.

To the Welsh Ministers,

Active Travel (Wales) Act 2013 Reporting Duties

In accordance with the duties under section 3 (7) of the Active Travel (Wales) Act 2013, please find below [insert LA name]'s report on the level of use of active travel routes.

<p>Number of existing Active Travel Routes</p>	<p>Insert number and length (if known) of existing active travel routes in your authority:</p> <ul style="list-style-type: none"> - Walking - Cycling - Shared use
<p>Baseline data at 2016</p>	<p>Insert original levels of active travel in your authority. e.g.</p> <ul style="list-style-type: none"> - Number of trips recorded - Percentage of children walking or cycling to school - Percentage of travel to work trips by walking or cycling - Percentage of people making active travel journeys - If specific data is available for existing active travel routes, please indicate which routes and their usage levels
<p>What data was available in your local authority to record usage?</p>	<p>For example:</p> <ul style="list-style-type: none"> - automated counts - manual counts - Active Journeys data or other school travel surveys - SRIC monitoring data - workplace or visitor travel surveys - census data - national survey data - anything else that may be available locally

<p>New data at [insert reporting year]</p>	<p>Insert current levels of active travel in your authority e.g.</p> <ul style="list-style-type: none"> - Number of trips recorded - Number of children walking or cycling to school - Percentage of active travel as a mode of transport - Indicate existing active travel route(s) if specific is available as a comparison against baseline data
<p>What data will be available to support the next iteration of this report?</p>	<p>Insert anticipated methods e.g. counters on new routes</p>

(Please adapt the template to suit your requirements)

I confirm that this report will be published online and made available in hard copy on request, in accordance with the statutory Active Travel Act Guidance (2021 edition).

Chief Executive Signature:

--

Chief Executive Name:

--

Date of submission to Welsh Ministers:

--

Appendix G

List of Design Elements

Series 100 – Footpaths, ramps and steps

DE101 Footway	322
DE102 Footpath	325
DE103 Ramp	328
DE104 Steps	331
DE105 Wheeling ramp	333

Series 200 – Traffic calming and highway features

DE201 Raised table junction	335
DE202 Sinusoidal hump	337
DE203 Cycle bypass at narrowing	339
DE204 Cycle-only access with right turn facility	341
DE205 Quiet streets	343
DE206 Cycle streets	345
DE207 Central median strip	347

Series 300 – Cycle lanes and tracks

DE301 Segregated contraflow cycle lane	349
DE302 Unsegregated contraflow cycling	351
DE303 Mandatory cycle lane	353
DE304 Advisory cycle lane	355
DE305 Cycle lane passing car parking/loading	357
DE306 Cycle lane at side road	359
DE307 Cycle lanes with removal of centre lines	361
DE308 Cycle lane with light separation	363
DE309 Cycle lane with light separation at side road	365
DE310 Car parking/loading with light separation	367
DE311 Stepped cycle track	369
DE312 Stepped Cycle Track at Side Road	371
DE313 Cycle track alongside road, separated from pedestrians	373
DE401 Shared pedestrian and cycle track, alongside road	374
DE314 Two-way cycle track in centre of carriageway	376
DE315 Transition between carriageway and cycle track	378

Series 400 – Traffic-free facilities

DE401 Shared pedestrian and cycle track, alongside road	380
DE402 Separated pedestrian and cycle track, away from road	382
DE403 Shared pedestrian and cycle track, away from road	384

Series 500 – Bus stops and lanes

DE501 Bus stop: cycle lane bypass	386
DE502 Bus stop: island bus stop	388
DE503 Bus stop: bus boarder	390
DE504 Bus stop: shared use	392
DE505 Bus lane	394

Series 600 – Crossings and junctions

DE601 Unmarked informal junction	397
DE602 Shared or separated pedestrian and cycle track at side road with priority	399
DE603 Shared or separated pedestrian and cycle track at side road give way	401
DE605 Blended side road entry treatment	405
DE606 Simple uncontrolled crossings (walking, shared use or cycle only)	407
DE607 Cycle priority crossing	409

DE604 Side road entry treatment	409
DE608 Uncontrolled crossing with central refuge	411
DE609 Cycle track on opposite side to junction	413
DE611 Parallel crossing for pedestrians and cyclists	417
DE612 Puffin and ped-x crossings	419
DE613 Toucan crossing	422
DE614 Advanced stop line	425
DE615 Cycle bypass at traffic signals	428
DE616 Cycle lanes through signalised junction	430
DE617 Two stage right turn at traffic signals	432
DE618 Hold the left turn	434
DE619 Protected junction	436
DE620 Cycle track alongside one-way carriageway at cross-roads	438
DE621 Parallel signalled controlled crossing	440
DE622 Two-way cycle track at larger cross-roads	442
DE623 Mini roundabout	444
DE624 Compact 'continental' roundabout	446
DE625 Dutch style roundabout with cycle track priority	448
DE626 Pedestrian/cycle bridge	450
DE627 Subway/underpass	450

1. These design elements provide concise guidance, including dimensioned drawings where appropriate, on the layout and use of particular types of design solution. These DEs should be read in conjunction with chapters 11 & 12.

2. In order to enable authorities to gain experience in the use of more innovative techniques, as well as being able to apply more well-established solutions with confidence, each Design element has been given one of three statuses, defined as.



Standard details

Details that are well understood and should be applied as shown unless there are particular reasons for local variation.



Suggested details

Details that have not been widely applied in Wales but should be considered appropriate for use in the circumstances as advised.



Possible details

Details that are largely uncommon in Wales but have been used successfully in other places and may be considered for use in schemes to gain further experience.

3. Within this document those elements denoted as Standard Details will be regarded as “standards” for the purposes of section 3(6)(a) of the Active Travel Act.

4. The use of DE's categorised as Suggested Details or Possible Details will require careful monitoring by the highway authorities who implement them. More details of monitoring processes can be found in chapter 16.

5. The drawings and images provided are illustrative and will not cover all circumstances. They should be applied in the light of local context. Where appropriate references are given to other documents that will provide relevant advice, but readers should ensure that any such documents are the current editions.

Thanks to Arup and PJA for the original and revised design element drawings.

DE101 Footway

Measure and brief description

Footways provide routes for pedestrians within highways. A satisfactory footway of sufficient width is important to allow pedestrians to travel at their chosen speed and to pass one another safely. Footway widths may be increased by reallocating road space away from motor vehicles to pedestrians or increasing the usable width by removing street clutter. Footway provision for pedestrians is contingent on range of factors including the local context, static pedestrian activities such as seating or congregation near tourist attractions, crossing types, significant trip generators such as schools and workplaces, street clutter or pavement parking.

Benefits

- Provision of direct and safe movement space for pedestrians alongside carriageways and cycle tracks.

Key design features

- Surface materials should be even, firm and slip resistant in wet and dry conditions.
- Surface materials and layouts should be consistent in colour and tone, with good contrast between pedestrian routes, cycle tracks and carriageways.
- Manhole covers and service hatches should match surrounding material pavers and pavement treatments.
- Rest areas should be provided on a regular basis.
- Footways should normally be lit by the overall highway lighting system.

Dimensions

- Should ideally be level with a desirable maximum longitudinal gradient of 5% (1 in 20).
- Absolute maximum longitudinal gradient of 8% (1 in 12.5).
- Cambers and crossfalls should preferably be 2.5% (1 in 40) and should not exceed 3.3% (1 in 30) and an absolute maximum of 10% (1 in 10) at crossings.
- Footways will normally be separated from carriageways by a kerb. The desirable minimum kerb height is 60mm, which can be reliably detected by a blind or partially sighted person.
- Minimum obstacle-free footway widths (a) are shown below. Where it is expected that there will be high volumes of pedestrians, widths should be increased accordingly – see Guidance on Pedestrian Comfort in chapter 9.

Provision	a – Footway width (m)	Width can accommodate
Desirable minimum	2.0	Two wheelchairs or double buggies passing comfortably
Accepted minimum	1.8	Two pedestrians passing, one pedestrian passing a wheelchair or double buggy
Absolute minimum	1.5	Two wheelchairs or double buggies passing
Restricted width at immovable object	1.2	Provides space for a blind or partially sighted person to walk using a long cane, or with a guide dog, or alongside a person providing guidance.

- On roads with a speed limit of 40mph or above, or with over 1,500 HGVs AADT, it is desirable to allow an additional minimum of 0.5m of footway or verge width to allow for vehicle overhang and pedestrian 'kerb shyness'. There may also be a dead area of up to 0.5 m at the back of the footway where the footway is bounded by a vertical feature such as a wall, or by the entrances to buildings.
- Minimum headroom (b):
 - » Desirable minimum – 2.3m.
 - » Absolute minimum to isolated obstacles (e.g. signs) – 2.1m.

Other considerations

- Footways should be free of obstructions, with street furniture restricted to items which benefit pedestrians. These should be located in a street furniture zone out of the pedestrian flow, with adequate tactile and visual warning.
- Wherever possible lamp columns and other street furniture should be set back at least 0.5m from the edge of the footway.
- Hazard protection (a detectable object, eg tapping rail or similar, with a minimum height 150mm to underside):
 - » Isolated objects, eg advertising boards, that cause an occasional narrowing of a footway, but which project no more than 100mm from their base do not need hazard protection.
 - » Where the base of the projection is less than 300mm above ground level, no hazard protection is required.
 - » Where an object projects more than 100mm within a zone between 300mm and 2.1 metres above ground level hazard protection should be provided. See BS8300 for further details.
- At dropped kerbs and at side-road junctions the appropriate tactile paving should be provided.

Further References

- National Federation for the Blind (2013) – Access for Blind People in Towns. SS1401 (Circulated by DfT).
- Department for Transport (2005) – Inclusive Mobility.
- Department for Transport (2007) – Manual for Streets.
- British Standards Institution (2009/2010) – BS 8300:2009+A1:2010 Design of buildings and their approaches to meet the needs of disabled people. Code of practice.

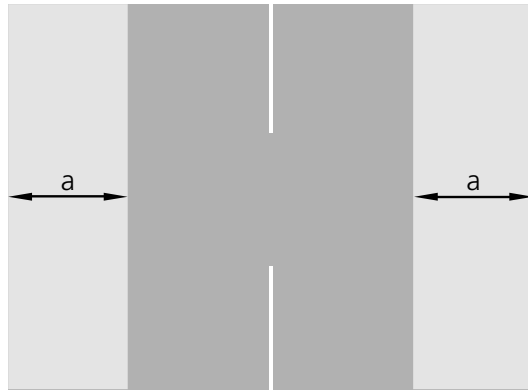

Plan

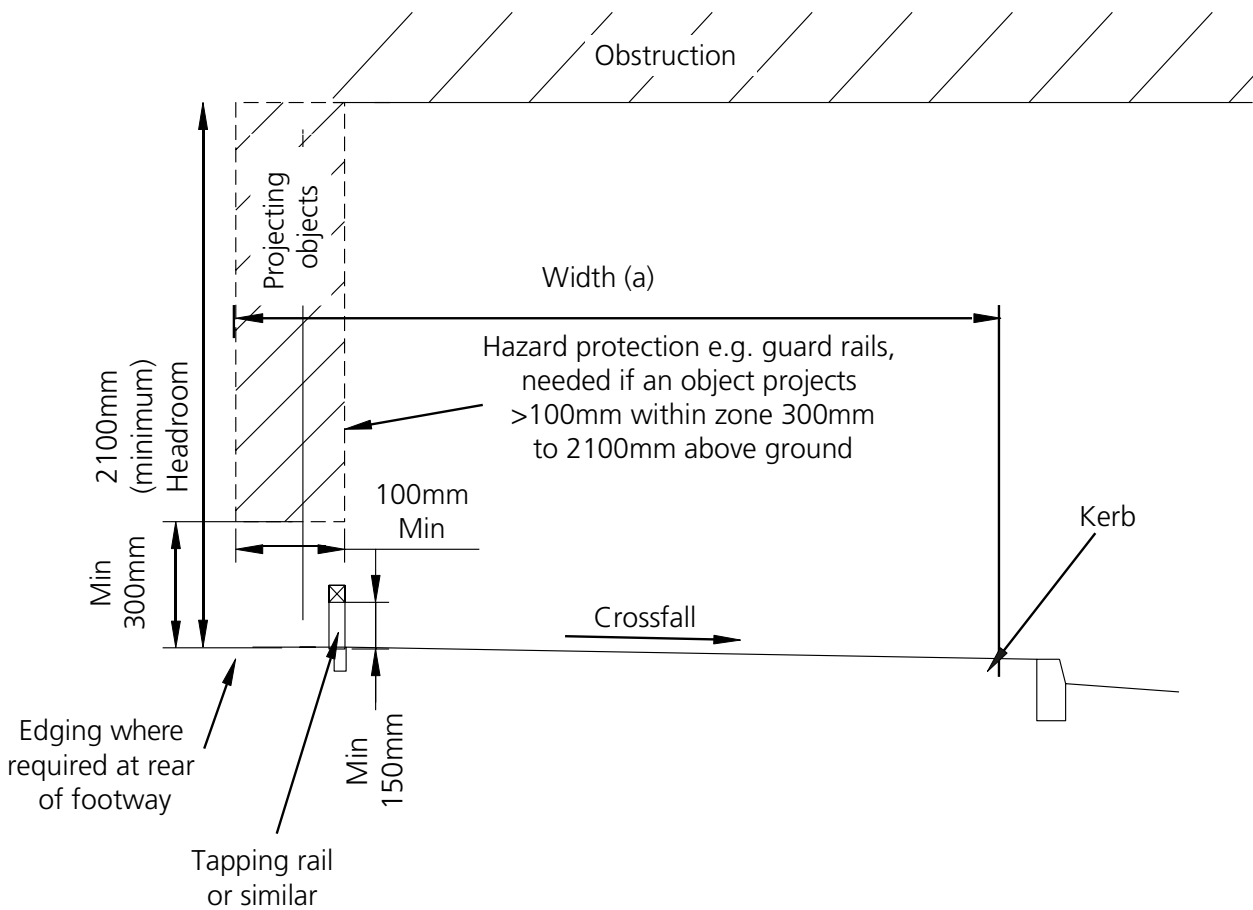

Cross section



DE102 Footpath

Measure and brief description

Footpaths provide separate direct routes for pedestrians for journeys in a range of locations such as through housing developments or across open space and countryside. A satisfactory footpath of sufficient width is important to allow pedestrians to travel at their chosen speed and to pass one another safely.

Benefits

- Provision of direct and safe movement of pedestrians typically linking footways.

Key design features

- Surface materials should be even, firm and slip resistant in wet and dry conditions.
- Surface materials and layouts should be consistent in colour and tone, with good contrast between the footpath and any cycle track.
- Manhole covers and service hatches should match surrounding material pavers and pavement treatments.
- Rest areas should be provided on a regular basis.
- Footpaths should be lit where users might otherwise be discouraged from using the route outside daylight hours.

Dimensions

- Should ideally be level with a desirable maximum longitudinal gradient of 5% (1 in 20).
- Absolute maximum longitudinal gradient of 8% (1 in 12.5).
- Cambers and crossfalls should preferably be 2.5% (1 in 40) and should not exceed 3.3% (1 in 30) and an absolute maximum of 10% (1 in 10) at crossings.
- Minimum obstacle-free footpath widths (a) are shown below. Where it is expected that there will be high volumes of pedestrians, widths should be increased accordingly – see Guidance on Pedestrian Comfort in chapter 9.

Provision	a – Footway width (m)	Width can accommodate
Desirable minimum	2.0	Two wheelchairs or double buggies passing comfortably
Accepted minimum	1.8	Two pedestrians passing, one pedestrian passing a wheelchair or double buggy
Absolute minimum	1.5	Two wheelchairs or double buggies passing
Restricted width at immovable object	1.2	Provides space for a blind or partially sighted person to walk using a long cane, or with a guide dog, or alongside a person providing guidance.

Other considerations

- Footpaths should be free of obstructions, with street furniture restricted to items which benefit pedestrians. These should be located in a street furniture zone out of the pedestrian flow, with adequate tactile and visual warning.
- Wherever possible lamp columns and other street furniture should be set back at least 0.5m from the edge of the footpath.
- Hazard protection (a detectable object, e.g. tapping rail or similar, with a minimum height 150mm to underside):
 - » Isolated objects, e.g. advertising boards, that cause an occasional narrowing of a footway, but which project no more than 100mm from their base do not need hazard protection.

- » Where the base of the projection is less than 300mm above ground level, no hazard protection is required.
- » Where an object projects more than 100mm within a zone between 300mm and 2.1 metres above ground level hazard protection should be provided. See BS8300 for further details.

Further References

- British Standards Institution (2009/2010) – BS 8300:2009+A1:2010 Design of buildings and their approaches to meet the needs of disabled people. Code of practice.

DE102

Footpath

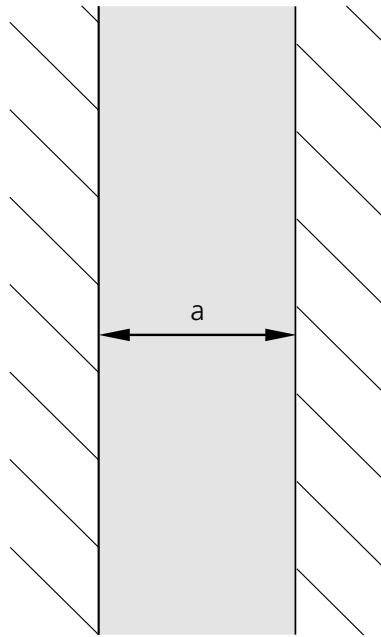

Footpath



Llywodraeth Cymru
Welsh Government

DE number: DE102

Previous DE number: DE002

Do Not Scale Drawing

Revision number: 2

Copyright: Welsh Government

DE103 Ramp

Measure and brief description

Ramps (defined as a gradient of more than 5% (1 in 20) are provided to facilitate a change in level or grade on a walking route. They should only be used where a change in level or grade cannot be avoided. In many places ramps will provide the alternative access to stairs for wheelchair users.

The details below refer to walking routes, with the gradients on cycle routes and shared use paths covered in chapter 9. A number of the considerations below should be included in the design process of shared use paths and cycle tracks including maximum gradients, the provision of handrails and landings or rest areas and no sudden changes in direction.

Benefits

- Ramps provide an accessible alternative to steps for disabled people, older people and parents and carers with pushchairs.

Key design features

- Where the change in level is no more than 200mm a ramp may be used without alternative steps.
- Desirable Maximum Gradient – 5% (1 in 20)
- Absolute Maximum Gradient – 8% (1 in 12). Steeper ramps will cause difficulties for manual wheelchair users
- Absolute Maximum Gradient over short distances (max 1m) - 10% (1 in 10) - eg on a ramp between a bus entrance and the pavement

Dimensions

- Ramp surface width
 - » Preferred Minimum – 2m
 - » Desirable Minimum – 1.8m
 - » Absolute Minimum – 1.2m
- Sides of a ramp should be protected by a raised solid kerb at least 100mm in height.
- If kerb height exceeds 75mm there must be no slot or gap greater than 20mm in the range of 75mm to 150mm. This is done to avoid the possibility of the footplate of a wheelchair riding over the kerb or becoming trapped.
- Ramp-side face of the kerb to be flush with, or no more than 100mm away from, the ramp-side face of the handrail.
- Handrails should be provided on each side, with a minimum clear width rail to rail of 1000mm. Where this unobstructed width exceeds 2000mm, a central, continuous handrail may be used as an alternative to a handrail on each side.
- Handrails should be provided on both sides of stairways and ramps and down the centre of stairs when their unobstructed width (ie between handrails) exceeds 1,800mm.
- Recommended height to the top of the principal handrail is between 900mm and 1000mm above the pitchline of the steps or above the surface of the ramp. On landings the top of the handrail should be between 900mm and 1100mm from the surface.
- Handrails should continue beyond the end of the ramp slope or end of the stairs by a (minimum) distance of 300mm and should either return to the wall or down to the floor or have a minimum rounded downturn of 100mm.
- Second, lower handrails for children and people of restricted growth are helpful and should be at heights of between 550mm and 650mm.

- The handrail itself should be smooth and comfortable to use by people with arthritic hands that is they should not be too small in diameter. Circular handrails should have a diameter between 40mm and 50mm; if not circular the handrail should be a maximum of 50mm wide by 38mm deep with rounded edges (radius of at least 15mm).
- There should be a clear space between the handrail and any adjacent wall of at least 50mm, preferably 60mm. Handrails should be supported centrally on the underside so there is no obstruction to the passage of the hand along the rail. There should also be a minimum of 600mm clear space above the handrail.

Other considerations

- There is a relationship between the length of a ramp and the gradient that people can manage; the longer the ramp the less severe the gradient that is feasible. One possible approach to this is, where a lengthy ramp is necessary, to design more frequent landings and lesser slopes for each successive segment.
- Ramps should never be longer than 132 metres in total and preferably no longer than 50 metres.
- Means should be provided to limit the risk of people colliding with the underside of freestanding ramps at any point where the clear height is less than 2.1m.
- The transition between the level and inclined parts of the ramp should be sufficiently rounded to ensure that a wheelchair user does not get caught by the foot supports.

Further References

- Department for Transport (2005) – Inclusive Mobility.

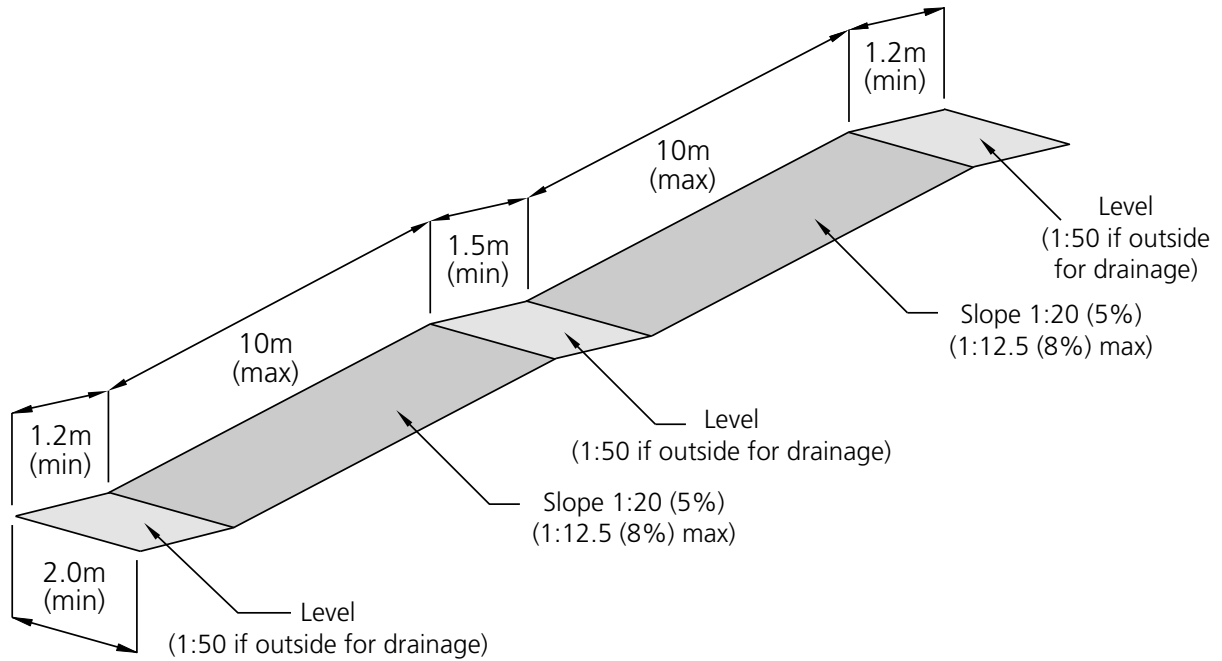

Ramp key dimensions

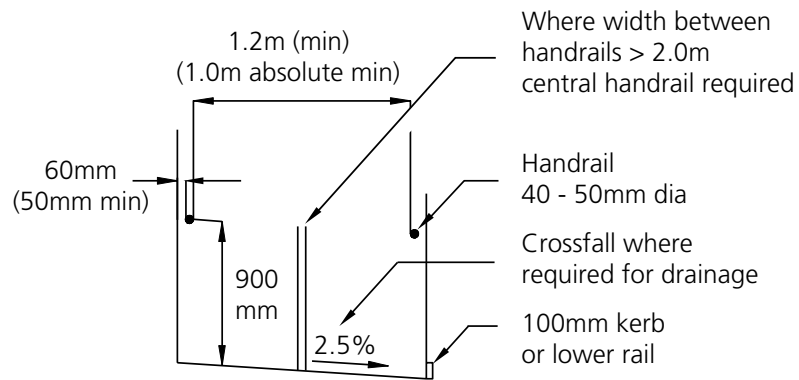

Section through ramp

Note:
Dimensions above for walking route ramps.



DE104 Steps

Measure and brief description

Steps allow direct movement for pedestrians from one level to another where there would otherwise be a significant gradient.

Benefit

- Direct routes for pedestrians.
- Steps can provide a useful shortcut to maintain desire lines where it is necessary to also provide a ramp to accommodate a change in level or grade.
- Steps built within public spaces are particularly popular because they can also serve as a good lookout point.

Key design features

- Steps should usually only be provided in conjunction with a ramp (or lift) in order to retain accessibility for disabled people, older people and parents and carers with pushchairs.

Dimensions

- A riser height of 150mm can be managed by most people; a little more than this is possible if there are well designed handrails but 170mm should be regarded as the absolute maximum in most circumstances. Steps with very shallow risers can cause problems and should be avoided; 100mm is the absolute minimum. All steps in a flight must have the same dimensions.
- Tread depth or going should be 300mm deep (approximately the length of a size 9 shoe), with an absolute minimum of 250mm.
- The nose of the step should be rounded (6mm radius) without any overhang.
- Steps should be well lit (minimum 200 lux) and surfaced with a slip resistant material.
- Colour/tonal contrast on the step noses is beneficial for blind and partially sighted people and should extend across the full width of each tread, 55mm deep on both tread and riser.
- The maximum number of risers in a flight should be 12, with resting places between successive flights. Resting places should have a Desirable Minimum length of 1.8m and an Absolute Minimum length of 1.2m, and be across the full width of the steps. The minimum number of steps in a flight should be three; fewer than this is less safe.
- The Desirable Minimum clear width between handrails is 1.2m which is sufficient for a disabled person and companion, with an Absolute Minimum width of 1m.
- Handrails should be provided on both sides and, where steps have a clear width of more than 1.8m, a centre handrail should also be provided.

Other considerations

- Means should be provided to limit the risk of people colliding with the underside of freestanding steps at any point where the clear height is less than 2.1m.
- Incorporation of corduroy warning paving to the top and bottom, and visual contrast between elements should be used to highlight features such as steps edges and handrails.
- Open tread steps are to be avoided, as are curved or spiral steps.
- There should be unobstructed landing space at the top and bottom of each flight of steps of a length at least equal to the unobstructed width of the steps.

Further References

- Department for Transport (2005) – Inclusive Mobility.

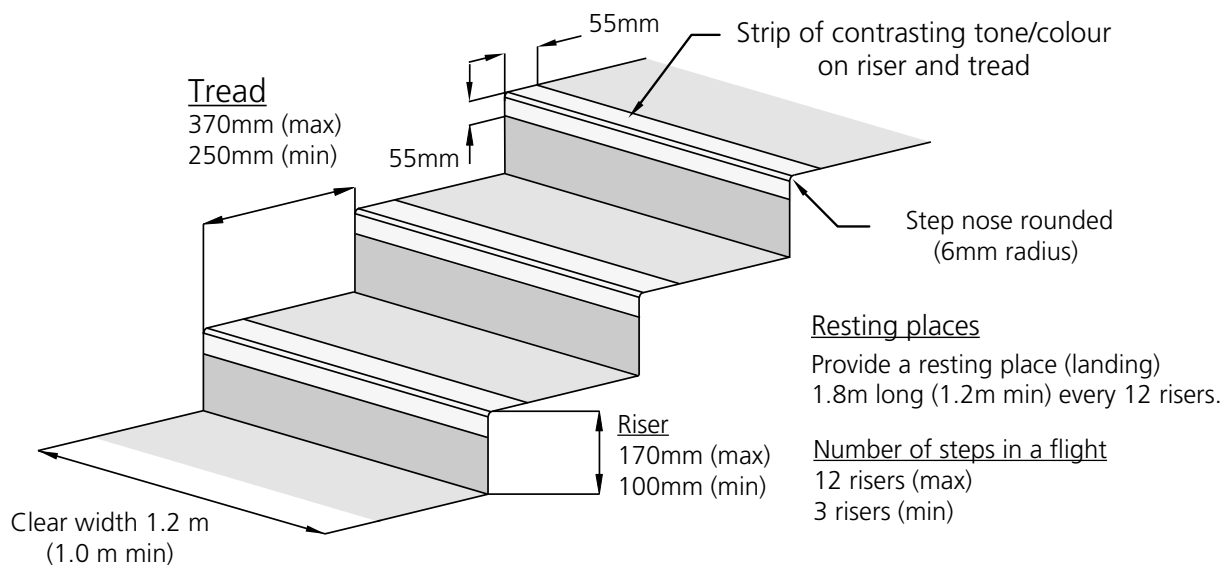

Pitch (angle) of steps

25° (min)

35° (max for high usage)

45° (absolute max)

Rule of thumb:

tread length + 2 x riser height = 600mm

Steps key dimensions

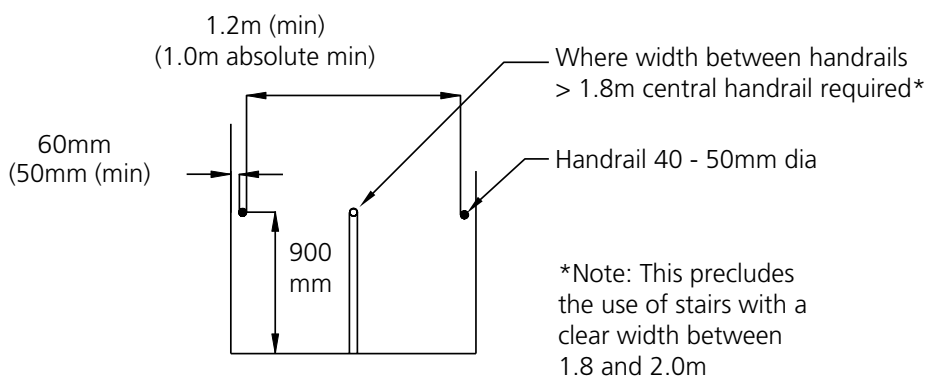

Section through steps



DE105 Wheeling ramp

Measure and brief description

Where cycle routes are introduced onto routes originally designed for pedestrian use only, such as canal towpaths or railway footbridges, flights of steps are sometimes unavoidable, at least in the short term. To assist cyclists, wheeling ramps should be added to the flights using steel sections or by forming them in concrete.

Benefits

- Enables cyclists to negotiate an existing footbridge or underpass at minimal cost where a ramp is not possible.

Key design features

- Locating the wheeling ramp close to the wall minimises the trip hazard for pedestrians.
- The ramp and hand rail should be far enough away from the side-wall to allow cyclists to use it without the side-wall snagging their handlebars (including cycles with wide handlebars), but not so far out as to impede less-able pedestrians from using the hand-rail. In practice, the wheeling ramp should normally be directly below the hand-rail, with enough height difference between them for a bicycle, angled slightly outwards, to fit beneath the hand-rail.
- The wheeling channel needs to extend beyond the top and bottom steps to provide a smooth transition.
- Steel sections should have a nonslip surface so that the tyres grip the ramp on descent.
- In most cases the ramp is fitted to one side, usually on the right for people climbing, but on well used routes a ramp on each side may be considered.

Dimensions

- A channel 100mm wide and 50mm deep is generally suitable.
- The centres of the channel and hand rail should be 200mm from the side wall for ease of use.
- Handrail should be above wheeling ramp, with the centre of both being 200mm from the wall.

Other considerations

- Wheeling ramps should not obstruct convenient access to the handrail nor be located in the centre of the steps where they might form a trip hazard.
- Where a ramp is constructed in metal, a continuous piece is preferred.
- In some instances timber and stone surfaces blend better with the original construction.
- Requires considerable effort from cyclists, especially with luggage.
- Are of no benefit to many non-standard cycles such as tricycles, cargo bikes and cycles with trailers.

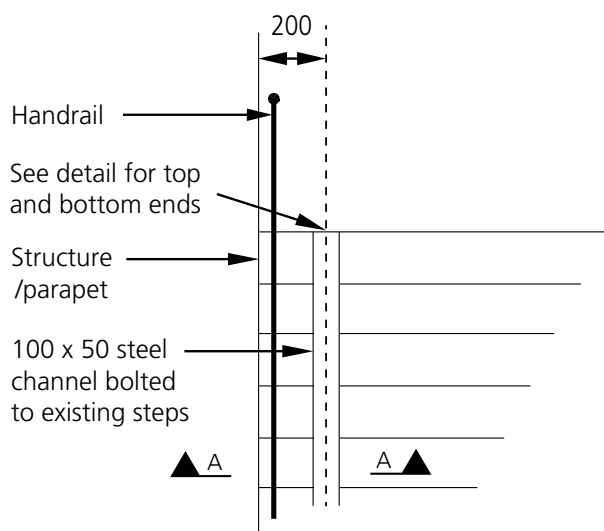

Elevation

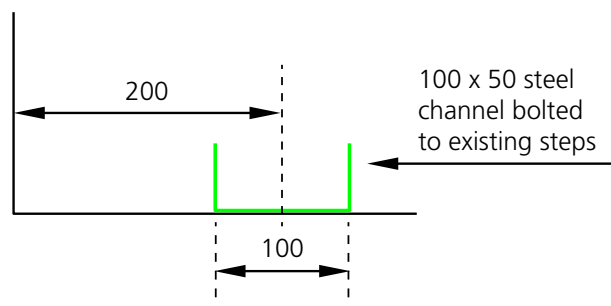

Section A - A

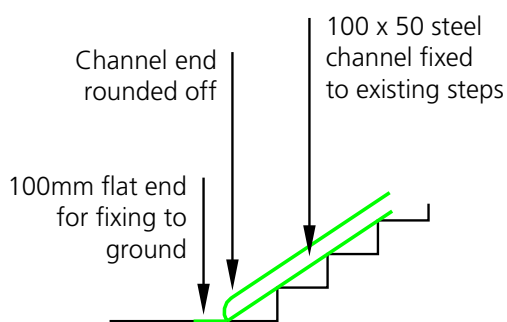

Bottom end detail

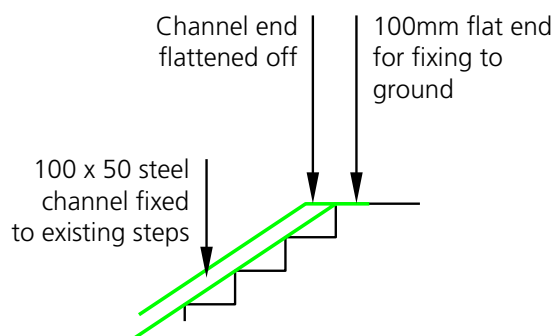

Top end detail



DE201 Raised table junction

Measure and brief description

Raised table junctions create safer environments for all users by reducing the speed of vehicles negotiating the junction. They are typically used at priority junctions but can also be applied to roundabouts (including mini roundabouts and implied roundabouts) and traffic signals.

Raised table junctions can be used on roads with a speed limit of 30mph or less, with adequate street lighting provision, in the following situations:

- urban/suburban residential and mixed use areas; and
- in town centres as part of public realm improvements, where raised tables at key junctions provide informal crossing points for pedestrians.

Raised table junctions are road humps and must comply with the Highways Act 1980, Sections 90A to 90F.

Benefit

- Raised tables emphasise the presence of a junction, encourage driver attention and lead to drivers giving informal priority to pedestrians.
- By reducing speeds, raised table junctions will commonly not require separate cycle facilities.
- The speed reduction effect of raised tables can be used to mitigate reduced visibility at some low volume/low speed junctions.
- Raised table junctions included as part of wider traffic calming measures can discourage through traffic.

Key design features

- The raised table must comply with the Highways (Road Humps) Regulations 1999.
- The raised table should extend from kerb to kerb to benefit pedestrians crossing. This will require attention to drainage requirements to avoid standing water at the ramps.
- Appropriate tactile paving should be provided at pedestrian crossing points.
- Approach ramps should be located sufficiently far from the junction mouth so that the changing level of the carriageway does not become problematic for cyclists when turning.
- It may be necessary to install build outs, bollards or introduce parking restrictions as appropriate in order to prevent parking around the junction.
- Drainage covers/gully gratings set flush with the footway to avoid becoming a hazard for pedestrians and cyclists.

Dimensions

- Approach ramps with a sinusoidal profile will reduce discomfort for cyclists compared to a 1 in 10 ramp.
- Table height should normally be 75mm, maximum 100mm.
- Kerb radii to be reduced to 2-3m, subject to vehicle tracking (and allowing for vehicles to cross centrelines unless flows are high).

Other considerations

- Bollards may be provided to prevent over-run on corners.
- Strengthened corners may be necessary if over-run is to be expected.
- Raised tables can usefully be provided between junctions, using similar design criteria.
- Corduroy hazard paving can be used in addition to the blister paving where there is a lack of a kerb upstand – early engagement with groups representing people with sight loss and other disabilities is essential, particularly where new or uncontrolled crossings are proposed.

Further references

- Department for Transport (2007) – Local Transport Note 01/07. Traffic Calming.

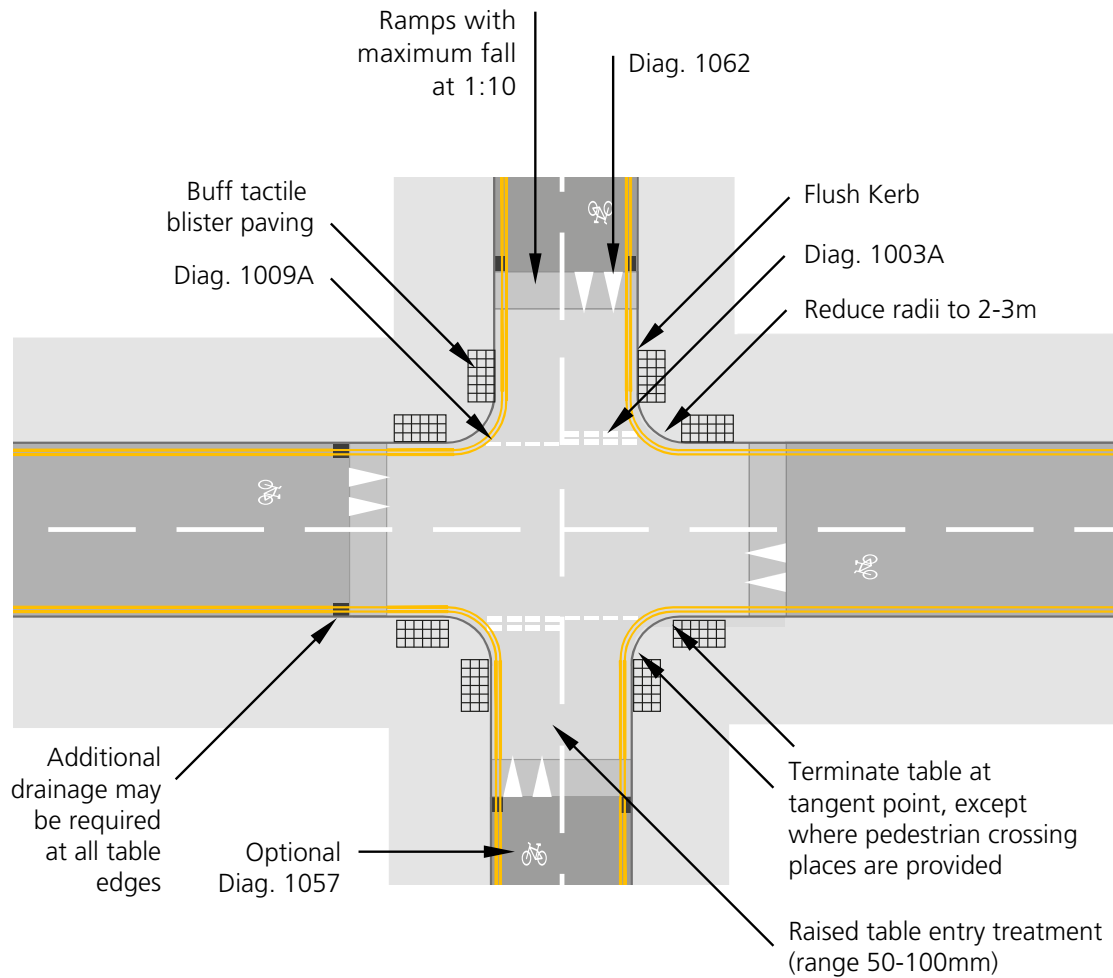

DE202 Sinusoidal hump

Measure and brief description

Traffic calming measures are used to reduce motor vehicle speeds thereby improving safety for pedestrians and cyclists as well as improving living conditions for residents living along traffic calmed routes. The provision of sinusoidal profile humps reduces the discomfort for cyclists when riding over humps, whilst still being effective in reducing traffic speed.

Sinusoidal humps are road humps and must comply with the Highways Act 1980, Sections 90A to 90F.

Benefits

- Sinusoidal road humps minimise discomfort for passing cyclists and are effective at reducing motor-vehicle speeds.
- Improve perceived and actual safety for pedestrians and cyclists.
- Reduction in traffic speeds helps improve cyclist comfort and help create suitable cycle routes.
- Helps reduce the necessity for speed limit enforcement by Police.
- Can improve living conditions for residents living along traffic calmed roads.

Key design features

- The sinusoidal road hump must comply with the Highways (Road Humps) Regulations 1999.
- As an exact profile may be difficult to construct an approximate sinusoidal profile is acceptable, with a tapered entry and exit profile. Precast sinusoidal profile paving blocks are best avoided on routes that carry significant volumes of heavy vehicles (i.e. buses or lorries), as paving blocks are more likely to come out of position under their weight.
- The impacts on car parking should be considered.

Dimensions

- Hump height should normally be 75mm, maximum 100mm, see also Local Transport Note 1/07.

Other considerations

- Where a drainage gap is provided at the edge of a sinusoidal hump it should not be wide enough that drivers use it.
- Pre-cast sinusoidal ramps should not be used where there is high use by HGV traffic as they are likely to work loose.
- Councils are required to advertise and consult on sinusoidal humps, flat-top humps and speed cushions under the Highways (Road Hump) Regulations 1999.

Further References

- Department for Transport (2007) – Local Transport Note 01/07. Traffic Calming.

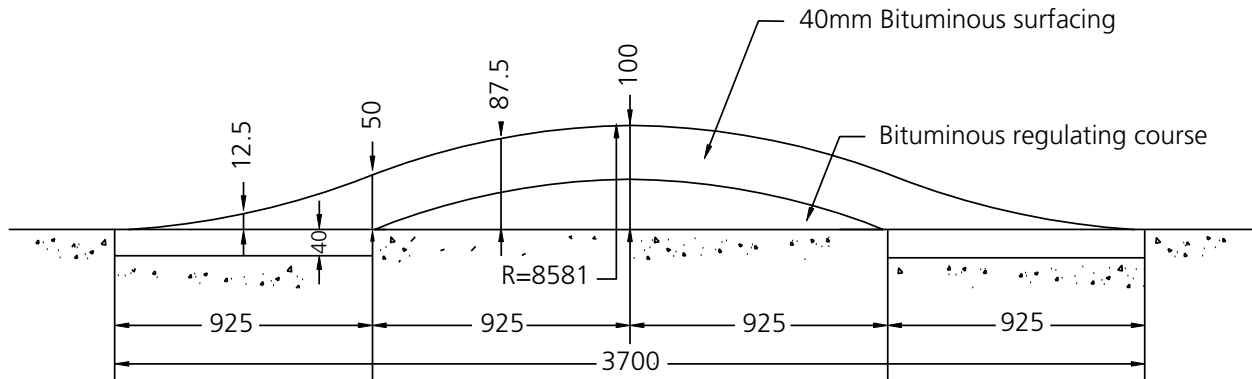

A. 100mm high hump

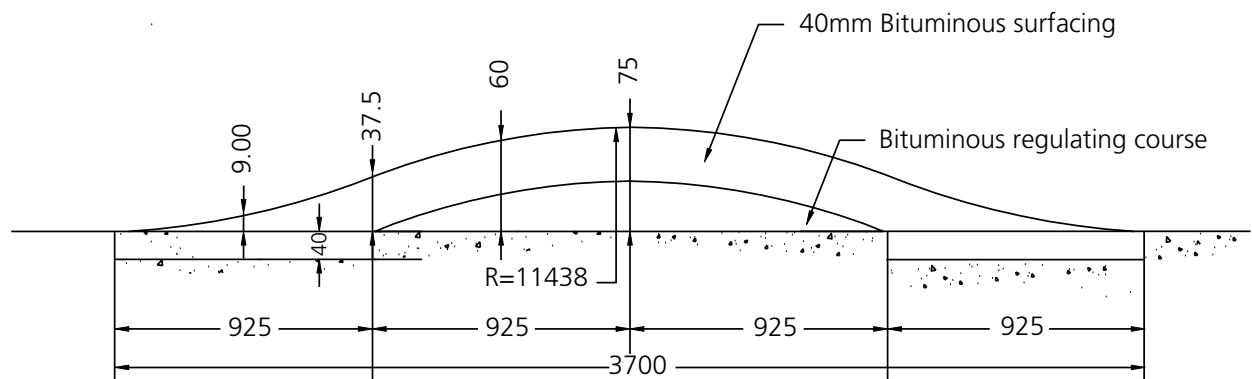

B. 75mm high hump

Notes:

Flexible construction is shown but other materials could be used, for example pre-cast concrete

R = Radius of sinusoidal hump

All dimensions are in mm



DE203 Cycle bypass at narrowing

Measure and brief description

Traffic calming measures are used to reduce motor vehicle speed thereby improving safety for pedestrians and cyclists as well as improving living conditions for residents living along traffic calmed routes. Traffic calming can improve cycling conditions, but where poorly designed it can also be uncomfortable and in some cases be intimidating and dangerous. Where horizontal traffic calming features are provided consideration should be given to providing bypasses for cyclists.

Benefits

- Cyclists are not intimidated or squeezed by motor traffic.
- Improve perceived and actual safety for pedestrians and cyclists.
- Reduction in traffic speed helps improve cyclist comfort and create suitable cycle routes.
- Helps reduce the necessity for speed limit enforcement.
- Can improve living conditions for residents living along traffic calmed roads.

Key design features

- Cycle bypass exits should not require cyclists to merge abruptly with motor vehicles.
- Parking and loading/waiting restrictions should be provided to avoid cycle bypasses becoming blocked by vehicles.
- Careful consideration should also be given to drainage at cycle bypasses to minimise gully grate conflict and flooding in the area.
- Bypasses should be wide enough to facilitate maintenance, e.g. street sweeper vehicles.

Dimensions

- a – cycle bypass to traffic calming features to be 2m desirable minimum (1.5m absolute minimum).
- b – gap for traffic between traffic calming features to be 3m max.
- c – avoid pinch point distances of between 3.2m – 3.9m.

Other considerations

- Bypasses should desirably be at carriageway level, in which case regular sweeping will be necessary.
- Footway level bypasses should consider impact on pedestrians, and additional drainage will be required

Further References

- Department for Transport (2007) – Local Transport Note 01/07. Traffic Calming.

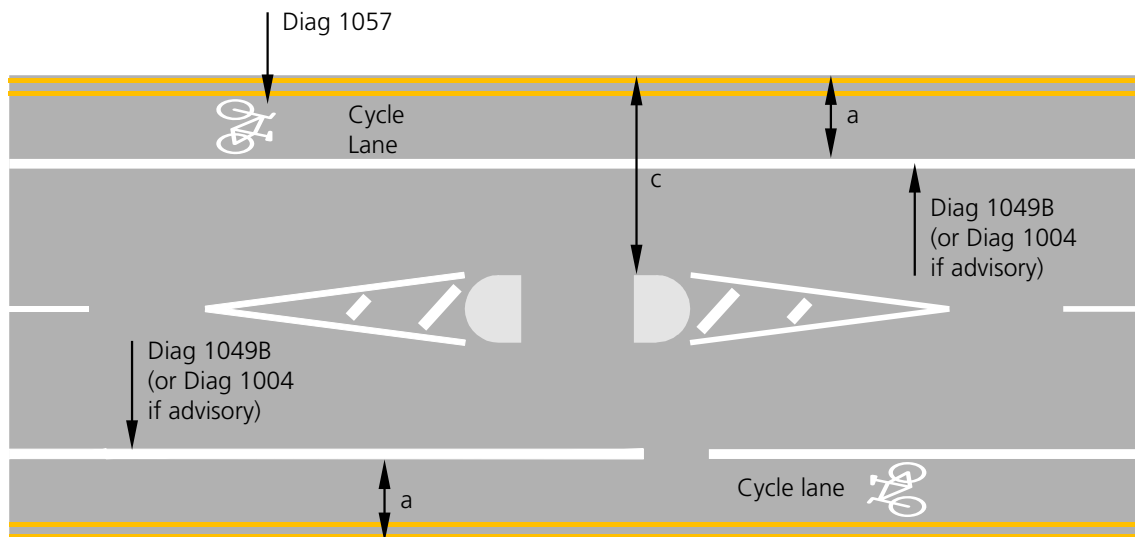
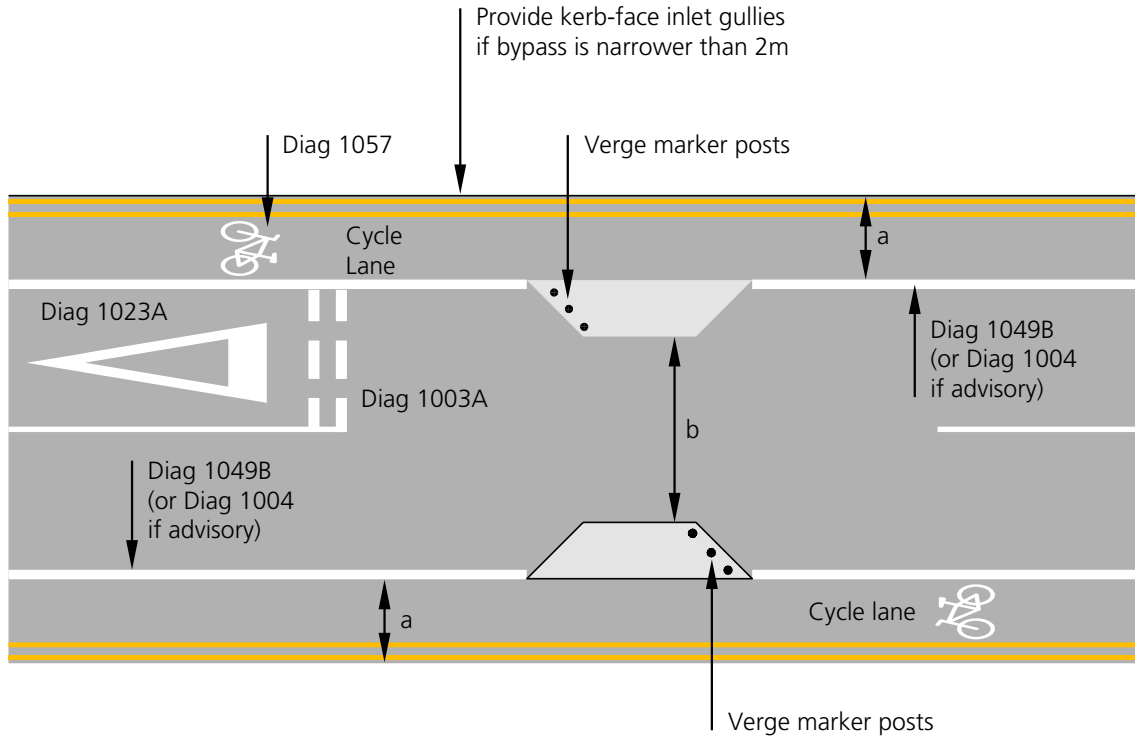

DE204 Cycle-only access with right turn facility

Measure and brief description

Cyclists should be exempted from restrictions applied to motor traffic on links or at junctions where safe to do so, or through the creation of short connections which are only available to cyclists and pedestrians, to give them time and distance advantages. This example shows how a cycle-only access can be provided which includes a central lane to assist right- turning cyclists.

Benefits

- Reduces cycle journey times.
- Increase permeability of area for cyclists.
- Provide convenient and attractive routes.
- Helps to reduce through traffic in neighbourhoods where motor traffic in residential streets is a problem, helping to deter unnecessary car trips.
- Relatively low cost.
- Can be retro-fitted to existing streets.

Key design features

- Traffic movements are often banned to help ease congestion by deterring traffic from certain streets. It is possible to exempt cycles from turning bans without having to significantly change the physical nature of the road.
- Where a closure is planned the preferred method is by the use of bollards with cycle signing mounted on them.
- Demountable bollards can be used to retain access for emergency vehicles. Dedicated right turn pockets for cyclists provide protection whilst waiting to make a turn.

Dimensions

- a – dedicated right turn pockets for cyclists to be 2m desirable minimum (1.5m absolute minimum).
- Width for cyclists at road closure to be 1.5m absolute minimum.

Other considerations

- Consideration should be given to:
 - » The potential for nuisance caused by powered two wheelers.
 - » Need to restrict car parking in the vicinity of the cycle gap, e.g. through double yellow lines.
 - » Providing good natural surveillance to deter crime.
 - » Potential need to maintain access for emergency vehicles.
 - » Pedestrian and cyclist interaction.
- Build outs or other features may be needed to keep the cycle gap clear of parked vehicles.
- The impact of road closures can be assessed by undertaking a trial closure on a temporary basis. The closure can then be made permanent if it is found to be successful.

DE204

Cycle-only access with right turn facility

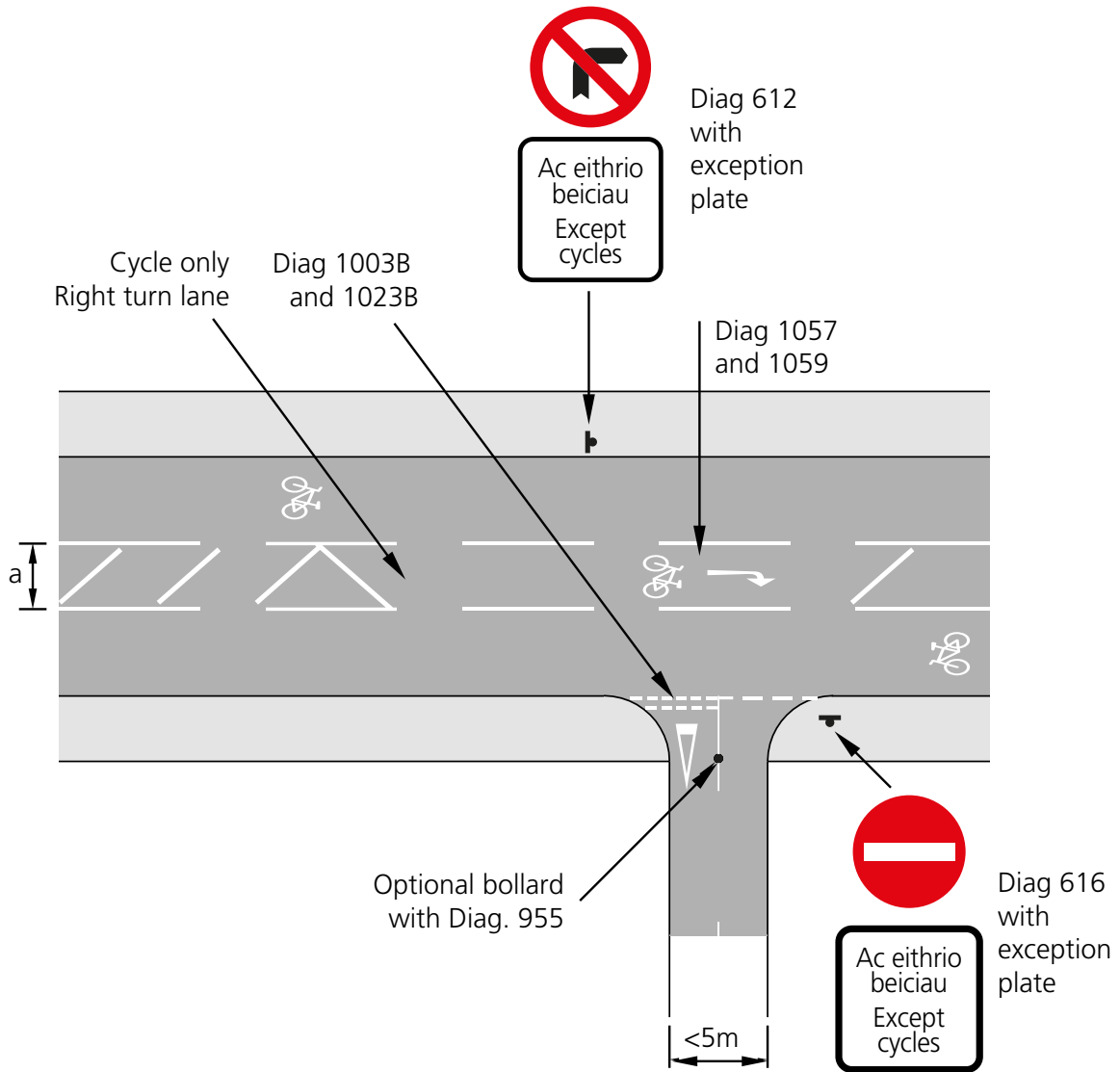

Llywodraeth Cymru
Welsh Government

DE number: DE204

Previous DE number: DE008

Do Not Scale Drawing

Revision number: 2

Copyright: Welsh Government

DE205 Quiet streets

Measure and brief description

Quiet Streets is a term given to urban cycling routes on low traffic speed and volume back streets, which are particularly suitable for new and less confident cyclists. Routes should maintain continuity for cycling and tackle physical barriers such as busy junctions, narrow paths, and should minimise diversions away from desire lines.

Cycle symbols to Diagram 1057, without necessarily the use of vertical signs to diagram 967, can be used to sign the continuity of cycle routes and indicate the correct positioning for cycling within the carriageway; in doing so they also help to raise motorist's awareness of cyclists, encouraging them to give cyclists space.

Benefit

- Continuous direct routes for cycling following desire lines.
- Relatively low cost solution.
- Largely un-separated from motor traffic but separation can be used when required.
- Secure and perceived as secure (socially safe).

Key design features

- Routed generally via lightly-trafficked roads (less than 2500 vehicles AADT on primary cycle routes and 5000 vehicles AADT on secondary cycle routes) and very limited HGV traffic.
- Where traffic volume levels exceed these values, traffic reduction or a filtered permeability approach should be used to reduce motor vehicle volume.
- Traffic speeds to be low – average below 20mph.
- Diagram 1057 can be useful to improve legibility of the route where needed.
- Points of conflict with oncoming and crossing traffic, parked vehicles and loading bays (kerbside activity) should be minimised.
- Minimise overall delays and provide route continuity and safety by prioritising cycle movements at junctions.

Dimensions

- Where 1057 markings are provided to highlight the route they should be spaced at regular intervals.

Other considerations

- TSRGD no longer requires the use of vertical signs to diagram 967 with diagram 1057 markings, and authorities may choose to only place signs where there is a clear need to alter other road users to the presence of a cycle route.

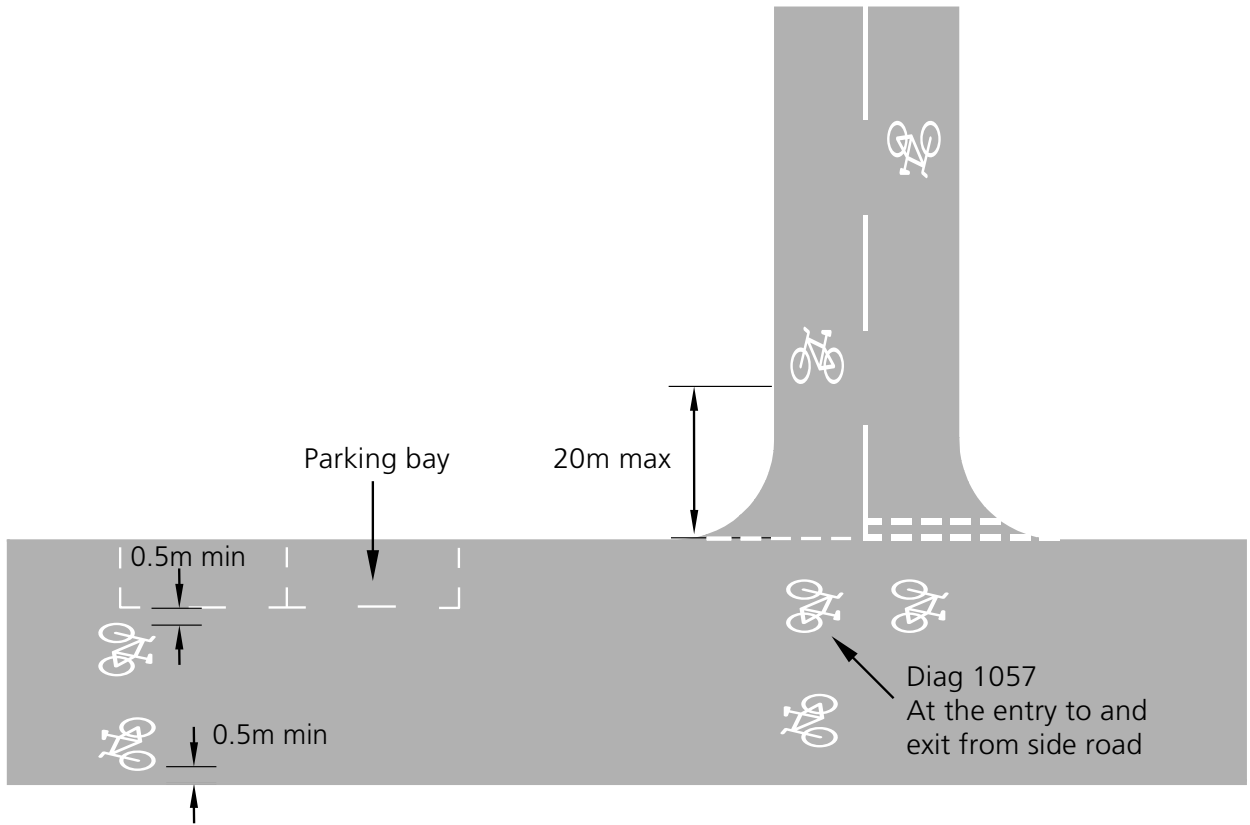

DE206 Cycle streets

Measure and brief description

A Cycle Street is a Quiet Street which also serves as a Primary Cycle Route. It should carry low levels of low speed motor traffic, high levels of cycling, and provide cyclists with a level of service comparable to that provided by a high quality traffic free route. The objectives of a Cycle Street are to:

- present a legible design recognisable to all types of user as a main cycle route
- influence behaviour so that cyclists assume priority over motor vehicles
- maintain priority for cyclists
- attract experienced cyclists as well as less confident cyclists

There is no standard design; design approaches should be creative, easily maintainable and adaptable – the design detail provided is one indicative solution; the street must be physically recognisable, including from side roads.

Benefit

- Improved cyclist safety and subjective safety.
- Improved route legibility.

Key design features

- Street design should encourage cyclists to assume priority, with motor vehicles travelling slowly and not overtaking them.
- Cyclists should have priority along links and at junctions to increase convenience.
- The length over which a car has to follow a cyclist should be limited to between 200m and 400m.
- Street should carry no more than 2,500 motor vehicles AADT.
- Where traffic volume levels exceed these values, traffic reduction or a filtered permeability approach should be used to reduce motor vehicle flows.
- Traffic speeds to be low – average below 20mph.

Dimensions (Illustrative design)

- a – traffic lane width 1.5m absolute minimum, 3m absolute maximum.
- b – central median, 1m desirable minimum.
- Where diagram 1057 markings are provided to highlight the route they should be spaced at regular intervals.

Other considerations

- TSRGD no longer requires the use of vertical signs to diagram 967 with diagram 1057 markings. Authorities may choose to only place signs where there is a clear need to alter other road users to the presence of a cycle route.

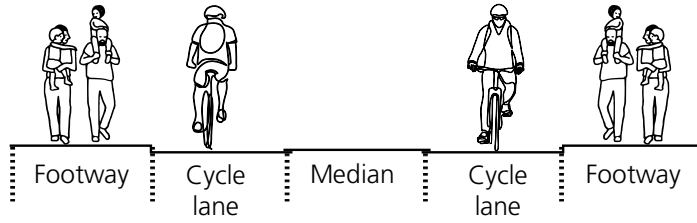

Diag 1057

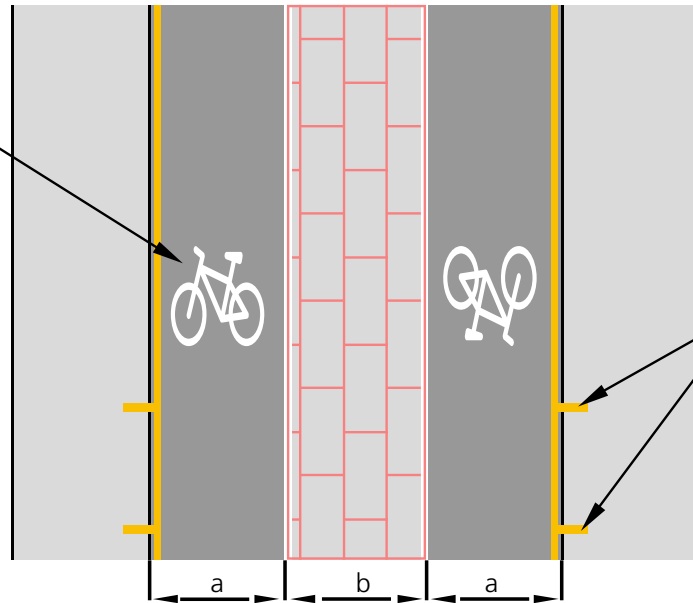

Large Diag. 1057
At regular intervals

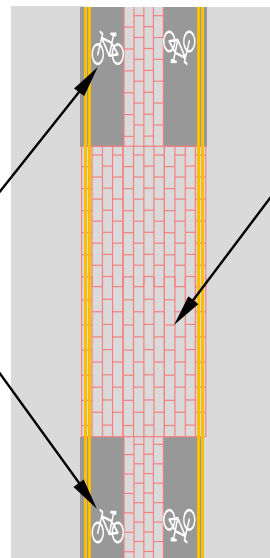

DE207 Central median strip

Measure and brief description

A central median strip is a long paved area of different coloured or textured surfacing in the centre of a carriageway which provides space for pedestrians to wait in while crossing a road in two stages at any point along its length whilst also helping to lower vehicles speeds.

Benefits

- Central median strips enable pedestrians to cross carriageways in two stages away from formal crossing points.
- This is particularly useful where crossing movements are distributed along a significant length, for example along a shopping street.
- These strips can also enhance the character of a highway and help to lower vehicle speeds. They also provide safety benefits to cyclists, helping to prevent collisions with motor vehicles turning into and out of the side road.

Key design features

- The width of the central median needs to be sufficient for a pedestrian to wait safely in the median for a gap in the traffic.
- The median may be constructed to enable vehicular overrun, or kerbed to prevent vehicular overrun.
- Kerbed medians will give the most confidence to pedestrians crossing. Central medians can be designed to be overrun so that the carriageways can be kept narrow but still allow for vehicles to pass stationary buses etc.
- Strips that are designed to be overrun can be flush or domed and/or constructed in rough surfacing so that vehicles travel slowly when travelling across the median.
- Designated crossing points may still be provided at intervals, with flush kerbs on the median and at the kerbs on the opposite side of the carriageways. Tactile paving should be provided at these flush kerbs. Raising the carriageway to footway level across the mouth of the side road.

Dimensions

- a – Lane width either side to be below 3.2m or above 3.9m, avoiding the critical lane width range for cyclists.
- b – Width of median strip should be a desirable minimum of 2.0m to accommodate a wheelchair and the person pushing and an absolute minimum of 1.2m.
- Minimum kerb height of 60mm is recommended, with an absolute minimum of 50mm.

Other considerations

- Unless kerbed, the form of construction of the median strip will need to accommodate vehicular overrun.
- Subject to vehicle tracking requirements, trees and planting can be placed in the central median.



Kerbed median

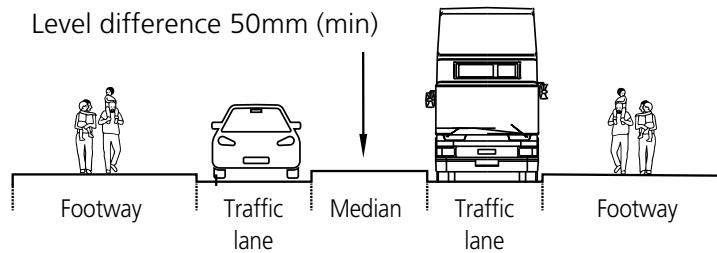

Humped median

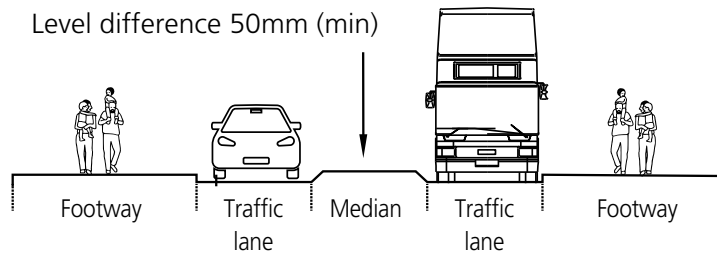

Flush median

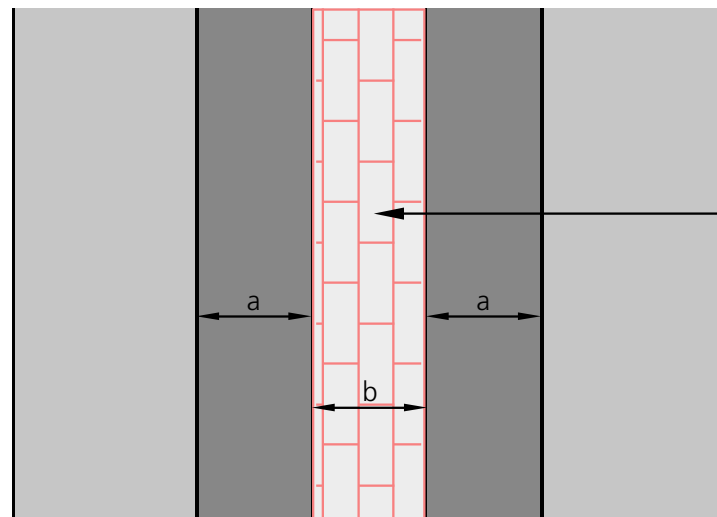
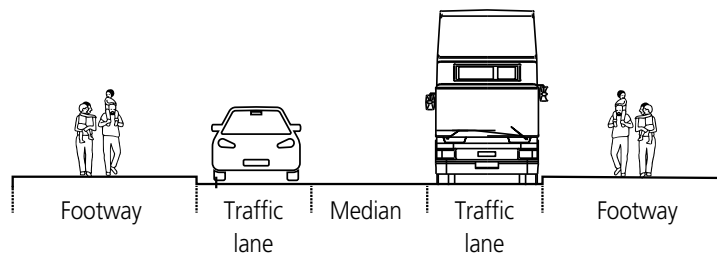

A material of differential colour, tone and/or surfacing should be used for the medianstrip



DE301 Segregated contraflow cycle lane

Measure and brief description

The permeability of the road network for cyclists can be greatly enhanced by exempting them from one-way restrictions. This provides connections that are only available to cyclists and reduces their travel times and distances. Segregated contraflow cycling can be provided by using a cycle lane – either mandatory or advisory – or with physical separation.

Benefit

- Improves cycle journey directness.
- Enables cyclists to avoid longer routes on busy roads.
- Gives cycling an advantage over motor traffic.
- Likely to reduce the number of cyclists riding on the footway.
- In one-way streets contraflow cyclists have better vision of people exiting parked vehicles facing towards them.
- Affordable and relatively straightforward to introduce.

Key design features

- Mandatory cycle lane should be used in preference to advisory cycle lanes where space permits.
- Advisory lanes may be a suitable option where oncoming vehicles need to encroach into the cycle lane, eg to pass obstructions.
- An advisory lane can be considered if the 85th percentile speed is less than 25 mph or traffic flows are below 1000 AADT.
- Physical segregation may be appropriate where motor vehicle speeds and/or volumes are high, in the form of kerb separation or light segregation.
- Where kerb separation is provided, gaps should be used to allow cyclists access to the carriageway and junctions.
- Where contraflow lanes pass parked cars a 0.5m wide buffer zone should be provided.
- Entry points for general traffic should preferably be provided with an island with sufficient cycle gap that will not be blocked by parked vehicles, as it gives added protection to cyclists against turning vehicles.
- 1057 cycle symbols should be used at entrances/exits and across side roads to alert drivers of likely cycle movements.
- 'Except cycles' signs with 'No Entry' signs should be used rather than the 'No Motor Vehicle' sign (Diagram 619).

Dimensions

- Cycle lane width (a):
 - » with mandatory or advisory lane or light segregation: 2m desirable minimum, 1.5m absolute minimum.
 - » with physical segregation: 2m minimum.

Other Consideration

- Contraflow cycle lanes should be designed to general guidance and standards for cycle lanes, including where they pass side road junctions.
- Traffic calming features that require contraflow cyclists to change their alignment should be avoided, for example speed cushions and build-outs.
- Waiting and loading restrictions should be included in TROs for contraflow lanes to prevent parked vehicles obstructing the lane and pushing cyclists into oncoming traffic.
- Echelon parking bays should be angled so that drivers reverse into them, so that they exit facing forwards and towards contraflow cyclists, therefore improving visual contact.
- Authorities may choose to omit vertical signs to diagram 960.1 and 960.2 when the speed limit is 20mph and the contraflow cycle lane is clearly visible.

Further References

- Department for Transport (2019) – Traffic Signs Manual.

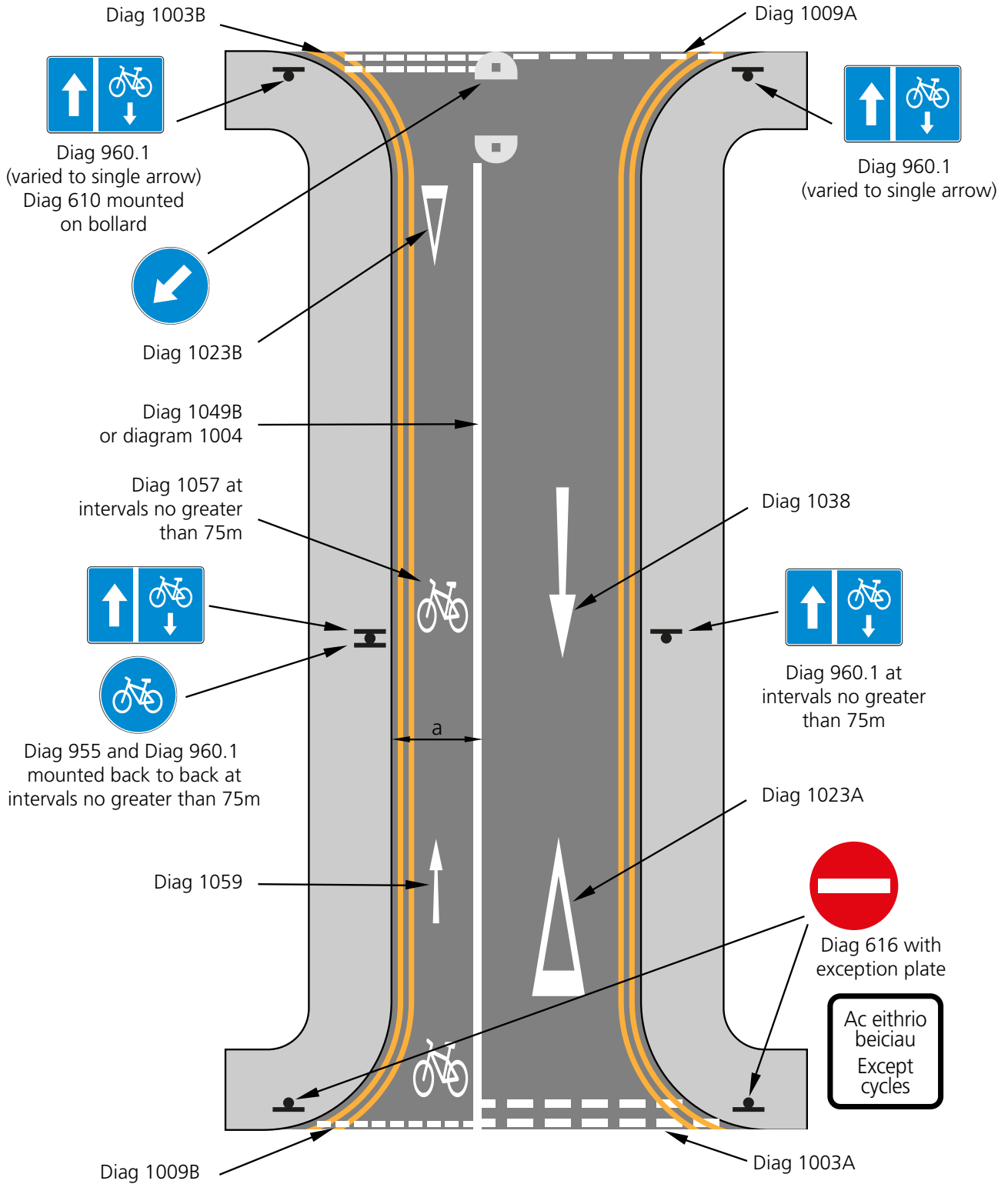

DE302 Unsegregated contraflow cycling

Measure and brief description

The permeability of the road network for cyclists can be greatly enhanced by exempting them from one-way restrictions. This provides connections that are only available to cyclists and reduces their travel times and distances. On less busy one-way roads with a narrow width two-way cycling may be permitted without a cycle lane.

Benefit

- Improves cycle journey directness.
- Enables cyclists to avoid longer routes on busy roads.
- Gives cycling an advantage over motor traffic.
- Likely to reduce the number of cyclists riding on the footway.
- In one-way streets contraflow cyclists have better vision of people exiting parked vehicles facing towards them.
- Affordable and relatively straightforward to introduce.
- Can be introduced without a cycle lane where traffic volumes and speeds are low.

Key design features

- Mandatory cycle lane should be used in preference to advisory cycle lanes where space permits.
- Where the 85th percentile speed is less than 25mph and traffic flows are below 1,000 AADT, or where the street forms part of a 20mph zone.
- At entries and exits, consideration should be given to alert drivers and pedestrians of contraflow cycle movements using a short section of cycle lane.
- Cycle logos and directional arrows should be used especially at entrances/exits and across side roads to alert drivers of likely cycle movements.
- 'Except cycles' signs with 'No Entry' signs should be used rather than the 'No Motor Vehicle' sign (Diagram 619).

Dimensions

- Sufficient carriageway space is required to ensure cyclists have enough space to pass oncoming vehicles, however it is possible to facilitate contraflow cycling in lightly trafficked narrow streets, including where there is car parking on one or both sides and a narrow running lane.
- Carriageway width (a):
 - » Absolute minimum 2.6m (no car parking).
 - » Desirable minimum 3.85m based on car passing cycle (no car parking).
 - » Absolute minimum 4.6m (with car parking on one side).

Other considerations

- 20mph zone with traffic calming or 20mph limit is desirable.
- Traffic calming features that require contraflow cyclists to change their alignment should be avoided, for example speed cushions and build-outs.
- Echelon parking bays should be angled so that drivers reverse into them, so that they exit facing forwards and towards contraflow cyclists, therefore improving visual contact.
- Any car parking should preferably be on the opposite side of the carriageway to contraflow cyclists.
- However, where widths are very restricted, car parking on the cyclists' side will enable cyclists to wait in gaps between parked cars to avoid larger oncoming vehicles.

Further References

- Department for Transport (2019) – Traffic Signs Manual.

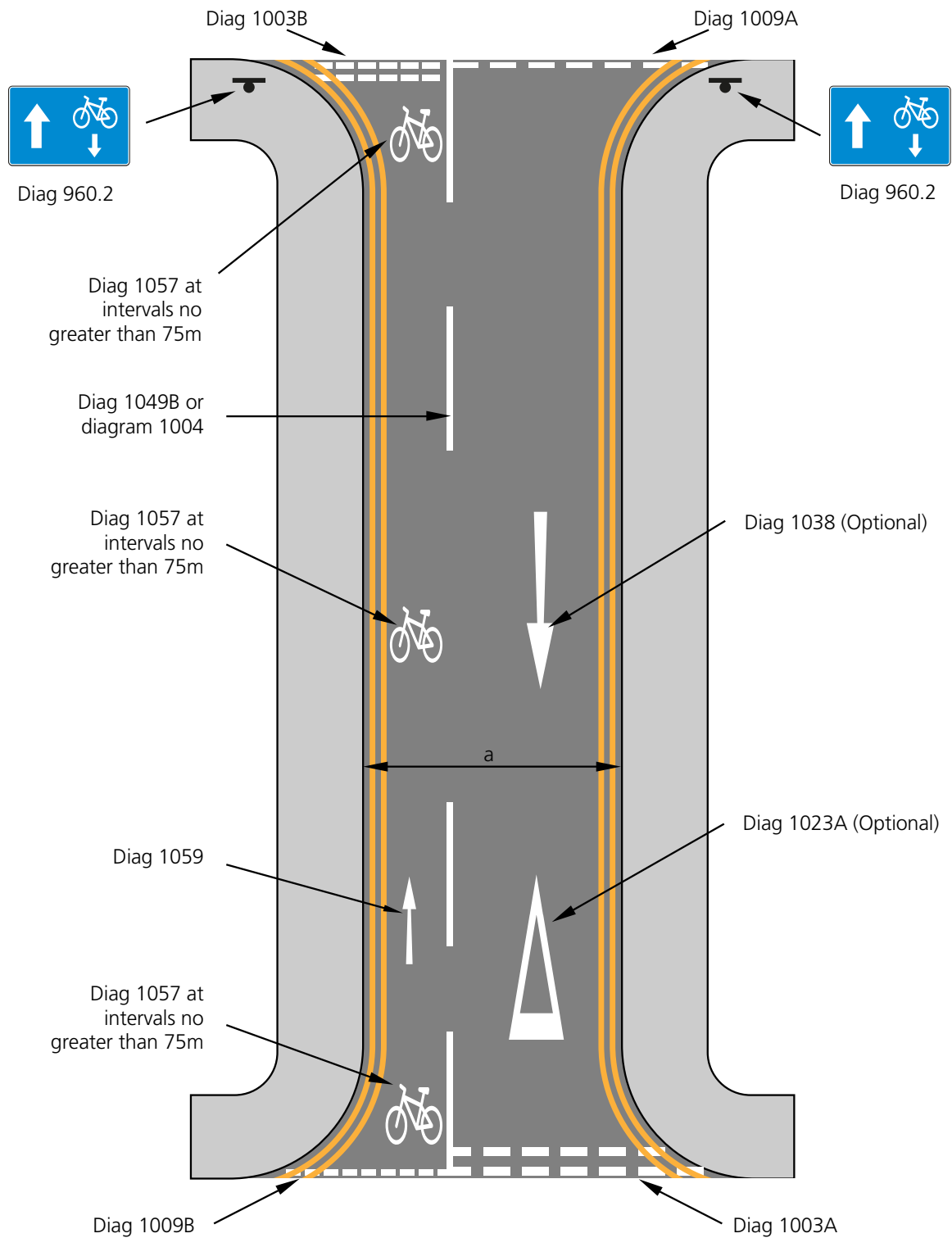

DE303 Mandatory cycle lane

Measure and brief description

Mandatory cycle lanes define an area of the carriageway that is reserved for cyclists and are suitable for roads where the speed limit is 30mph or less. Mandatory lanes are marked with a continuous white line (Diagram 1049B) which prohibits vehicles from entering the lane during the hours of operation, which should normally be at all times. There can be exceptions, such as emergency service vehicles and access to private driveways. Parking and loading should also be prohibited through appropriate controls. Mandatory lanes are preferable to advisory lanes and should be used unless there are particular local circumstances preventing their use. Following TSRGD in 2016, mandatory lanes do not require Traffic Regulation Orders to be made.

Benefit

- For exclusive use by cyclists during hours of operation (normally at all times).
- Delineated by solid white line, which is less likely to be crossed by motor vehicles.
- Can be enforced by the Police.
- Reduces the potential for conflict between motor vehicles and cycles compared to an advisory lane.
- Highlights presence of cyclists.
- Reduced lane width for motor traffic likely to reduce traffic speeds.

Key design features

- Continuity of cycle lane essential.
- Solid white delineation line 150mm wide (Diagram 1049B).
- Cycle symbol markings (diagram 1057) should be placed at the start of the lane and after every break, as well as at regular intervals on long uninterrupted lengths.
- TRO not required for use of marking but may be used to enforce parking.
- Lanes should operate at all times.
- Waiting and loading restrictions should apply at all times.

Dimensions

- a – Desirable minimum 2.0m, Absolute minimum 1.5m.
- Cycle lane entry taper 1:10, exit taper 1:5.

Other considerations

- Mandatory lanes must be discontinued at side road junctions but the use of a short length marking to diagram 1010 preserves continuity.
- Mandatory lanes can be continued across private accesses.
- Additional protection of cycle lanes can be provided using hatched road markings and traffic islands.
- A cyclist riding in the 'secondary' position will fill a 1.5m cycle lane, so if this width cannot be provided a cycle lane is unlikely to be appropriate.
- Inadequate cycle lane widths may increase conflict risk because drivers do not realise that cyclists need to move away from the kerb to avoid surface hazards. A narrow cycle lane may also give motorists (misplaced) confidence to provide less clearance while overtaking than they would in the absence of a cycle lane.
- Greater width should be considered on uphill cycle lanes to allow for additional lateral movement.
- A single uphill cycle lane is preferable to two sub-standard lanes.
- Cycle lanes constrain cyclists to the margin of the carriageway and so cycle-friendly gully gratings are essential.
- Authorities may choose to only place vertical signs to diagram 959.1 with each diagram 1057 marking where there is a clear need to alert other road users to the presence of the mandatory lane.

Further References

- Department for Transport (2019) – Traffic Signs Manual.

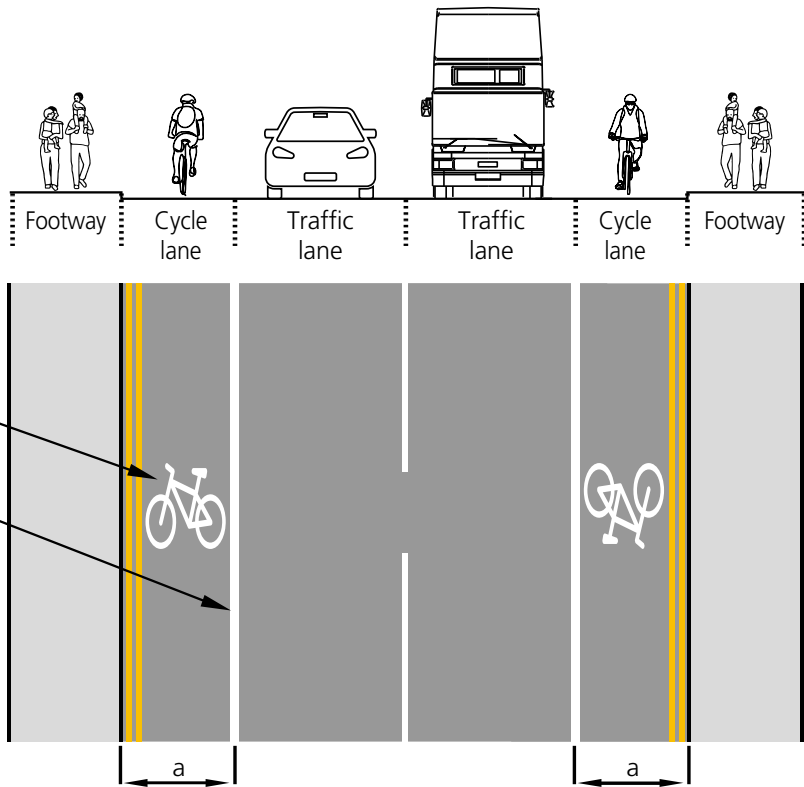

DE304 Advisory cycle lane

Measure and brief description

Advisory cycle lanes define an area of the carriageway that is intended for cyclists and are suitable for roads where the speed limit is 30mph or less. Advisory lanes are marked with a broken white line (Diagram 1004) which indicates that other vehicles should not enter unless it is safe to do so. Advisory lanes are less preferable than mandatory lanes, which should be used unless there are particular local circumstances.

Benefit

- Can be used in circumstances where a carriageway is not wide enough to permit full width mandatory cycle lanes, resulting in occasional motor vehicles entering the cycle lane.
- Can be useful to indicate routes through a large or complex junction.
- Reduces the potential for conflict between motor vehicle and cycles.
- Highlights presence of cyclists.
- Reduced lane width for motor traffic likely to reduce traffic speeds.

Key design features

- Continuity of cycle lane essential.
- Bounded by broken white line 100mm wide (diagram 1004).
- Cycle symbol markings (diagram 1057) should be placed at the start of the lane and after every break, as well as at regular intervals on long uninterrupted lengths.
- TRO not required for advisory cycle lane.
- Waiting and loading restrictions should apply at all times.

Dimensions

- a – Desirable minimum 2.0m, Absolute minimum 1.5m.
- Cycle lane entry taper 1:10, exit taper 1:5.

Other considerations

- Where width is constrained, a wider advisory cycle lane may be preferable to a narrow mandatory one.
- There can be benefits in continuing advisory cycle lanes through signalled junctions.
- Additional protection of cycle lanes can be provided using hatched road markings and traffic islands.
- A cyclist riding in the 'secondary' position will fill a 1.5m cycle lane, so if this width cannot be provided a cycle lane is unlikely to be appropriate.
- Inadequate cycle lane widths may increase conflict risk because drivers do not realise that cyclists need to move away from the kerb to avoid surface hazards. A narrow cycle lane may also give motorists (misplaced) confidence to provide less clearance while overtaking than they would in the absence of a cycle lane.
- Greater width should be considered on uphill cycle lanes to allow for additional lateral movement.
- A single uphill cycle lane is preferable to two sub-standard lanes.
- Cycle lanes constrain cyclists to the margin of the carriageway and so cycle-friendly gully gratings are essential.
- Authorities may choose to only place vertical signs to diagram 967 with each diagram 1057 marking where there is a clear need to alter other road users to the presence of the mandatory lane.

Further References

- Department for Transport (2019) – Traffic Signs Manual.

DE304

Advisory cycle lane

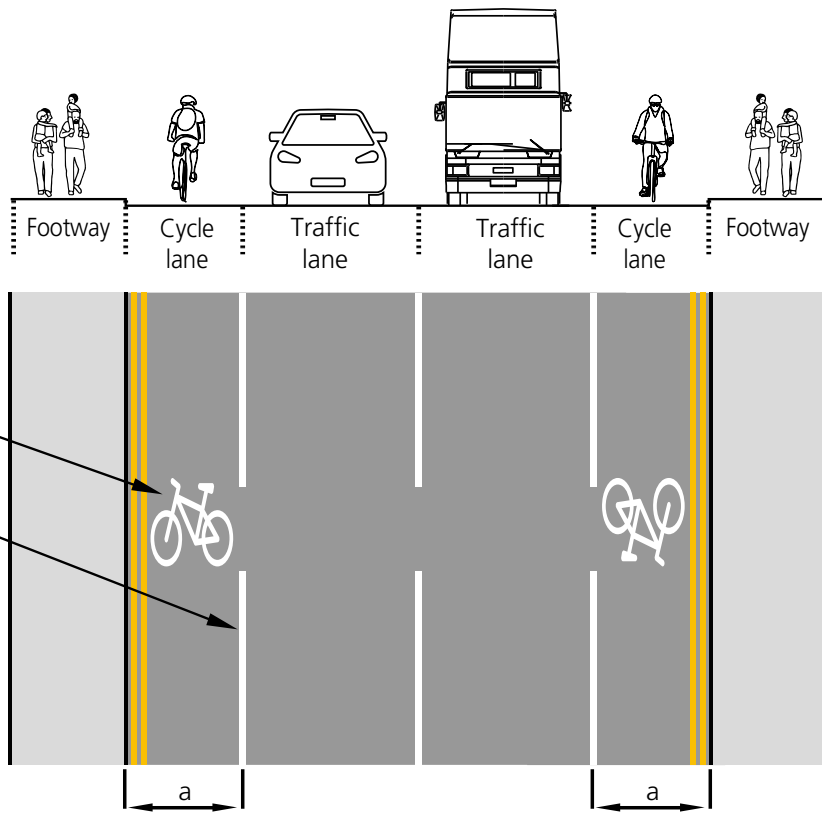

Llywodraeth Cymru
Welsh Government

DE number: DE304

Previous DE number: DE014

Do Not Scale Drawing

Revision number: 2

Copyright: Welsh Government

DE305 Cycle lane passing car parking/loading

Measure and brief description

Kerbside vehicle parking or loading can be dangerous for cyclists, especially parking spaces with high vehicle turnover rates, since there is a significant risk to cyclists from vehicle doors being opened. It is therefore highly desirable that cycle lanes pass vehicle parking areas with a dividing strip of sufficient width (buffer strip).

Benefit

- Prevents cyclists being hit by vehicle doors opening.
- Reduces the risk of cyclists having to swerve into traffic lane to avoid opening doors.
- Encourages good road positioning as taught in cycle training.
- Prevents cyclists getting trapped at the kerbside at the start of a parking bay.

Key design features

- Buffer strip between parking/loading bays and cycle lane.
- Hatched road markings may be used to define the buffer strip.
- Tapers required at approach to and at end of parking/loading bays.

Dimensions

- a – Desirable minimum 2m, Absolute minimum 1.5m.
- b – Buffer strip along parking/loading bays – desirable minimum 1m, absolute minimum 0.5m.
- c – width of parking/loading bays:
 - » for cars – minimum 2m wide.
 - » for vans – minimum 2.4m wide.
 - » for buses and HGVs min 2.8m wide (preferably 3.2m wide).
- d – general traffic lane should be 2.5m min width, or 3m where there are significant heavy vehicle flows.
- 1:10 approach taper to allow cyclists the opportunity to safely realign themselves before passing parked vehicles.
- 1:5 exit taper to allow cyclists the opportunity to safely realign themselves after passing parked vehicles.

Other considerations

- If there is insufficient width for a cycle lane and buffer strip past car parking, consideration should be given to narrowing traffic lanes or removal of centre line, rather than substandard facilities for cyclists.
- It may be possible to remove/relocate parking and introduce mandatory cycle lanes, for example if a street has adequate off-street car parking facilities or excess provision.
- Where carriageway widths are narrow and parking cannot be relocated or removed all day, timed mandatory cycle lanes could be considered for peak times.
- A 2.0m wide cycle lane can be reduced locally to 1.5m to allow a 0.5m wide buffer strip to be provided.

Further References

- Department for Transport (2019) – Traffic Signs Manual.



Cycle lane passing inside of parking/loading bays

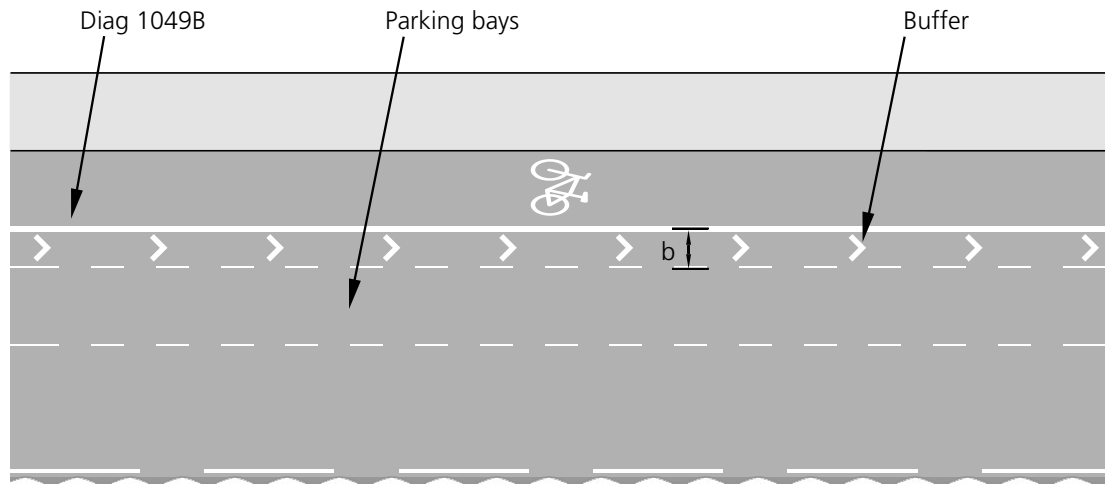

Cycle lane passing outside of parking/loading bays

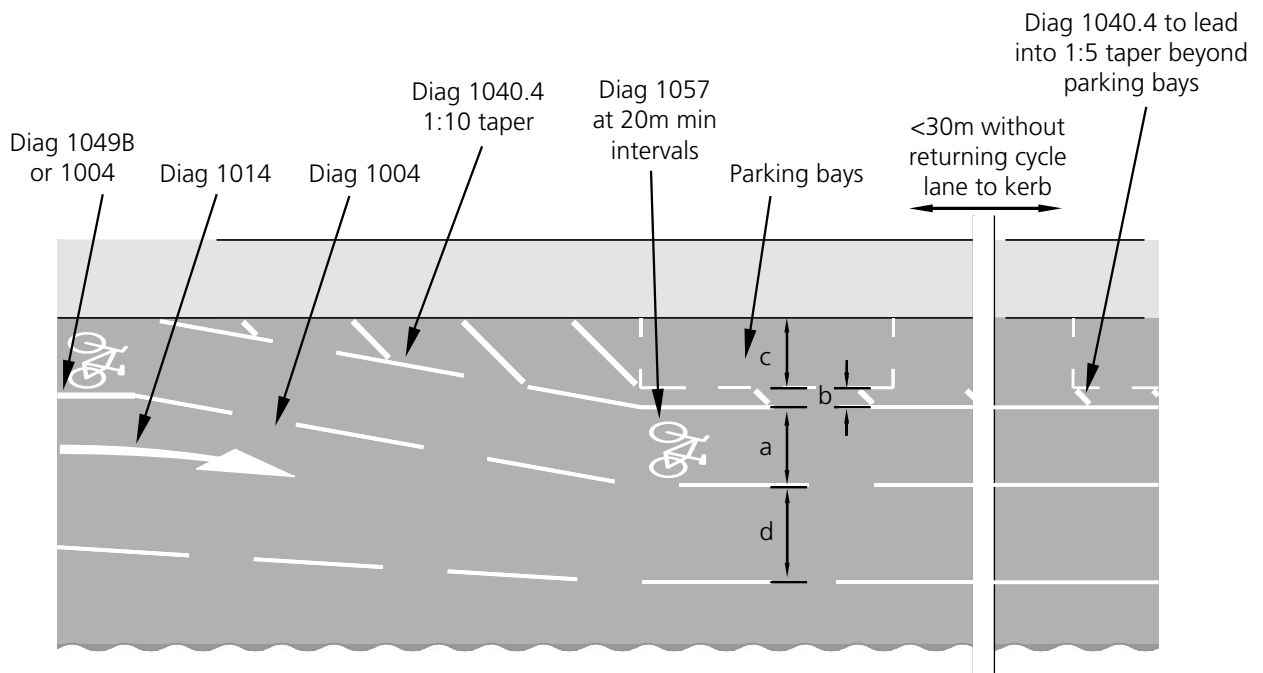

DE306 Cycle lane at side road

Measure and brief description

Cycle lanes should continue across side road junctions to ensure continuity and help improve safety. This can be achieved using a stretch of road marking to diagram 1010, where the white line is broken, since continuous mandatory lanes across side road junctions are not permitted and in preference to advisory cycle lanes to diagram 1004. It is recommended that the cycle lane width be increased at the mouth of side roads to encourage cyclists to position themselves further out from the kerb in order to increase its effectiveness and avoid conflict with vehicles nosing out of junctions.

Benefit

- Improves conspicuity of cyclists at conflict point.
- Provides route continuity.

Key design features

- The use of Diagram 1010 markings is recommended in preference to advisory cycle lanes to Diagram 1004 to increase conspicuity.
- Cycle symbols (Diagram 1057) may be placed in the cycle lane along the mouth of a junction.
- Coloured road surfacing may also be used in cycle lane to highlight the area of potential conflict.
- Wider cycle lanes across side roads help offer cyclists more space when cars encroach and encourage better road positioning by cyclists.

Dimensions

- a – Width on approach - desirable minimum 2.0m, absolute minimum 1.5m.
- b – Width at side road should be at least 0.5m greater than on approaches.
- c – general traffic lane should be 2.5m minimum width, or 3m where there are significant heavy vehicle flows.
- Widening at side road introduced with 1:10 entry taper and 1:5 exit taper.

Other considerations

- Side road entry treatments (DE604) should also be considered, which provide raised carriageway tables and reduced corner radii at side road junctions. They help reduce turning vehicle speeds, making it safer and more accessible for cyclists passing through the junction and pedestrians crossing the side road.
- Entry to and from side roads should be reviewed to ensure appropriate sightlines and speeds to mitigate risks to cyclists from turning traffic.
- Side-road warning signs to Diagrams 962.1 or 963.1 to warn motorists and pedestrians of the presence of cyclists are generally unnecessary except for situations where contra-flow cycling is permitted.

Further References

- Department for Transport (2019) – Traffic Signs Manual.

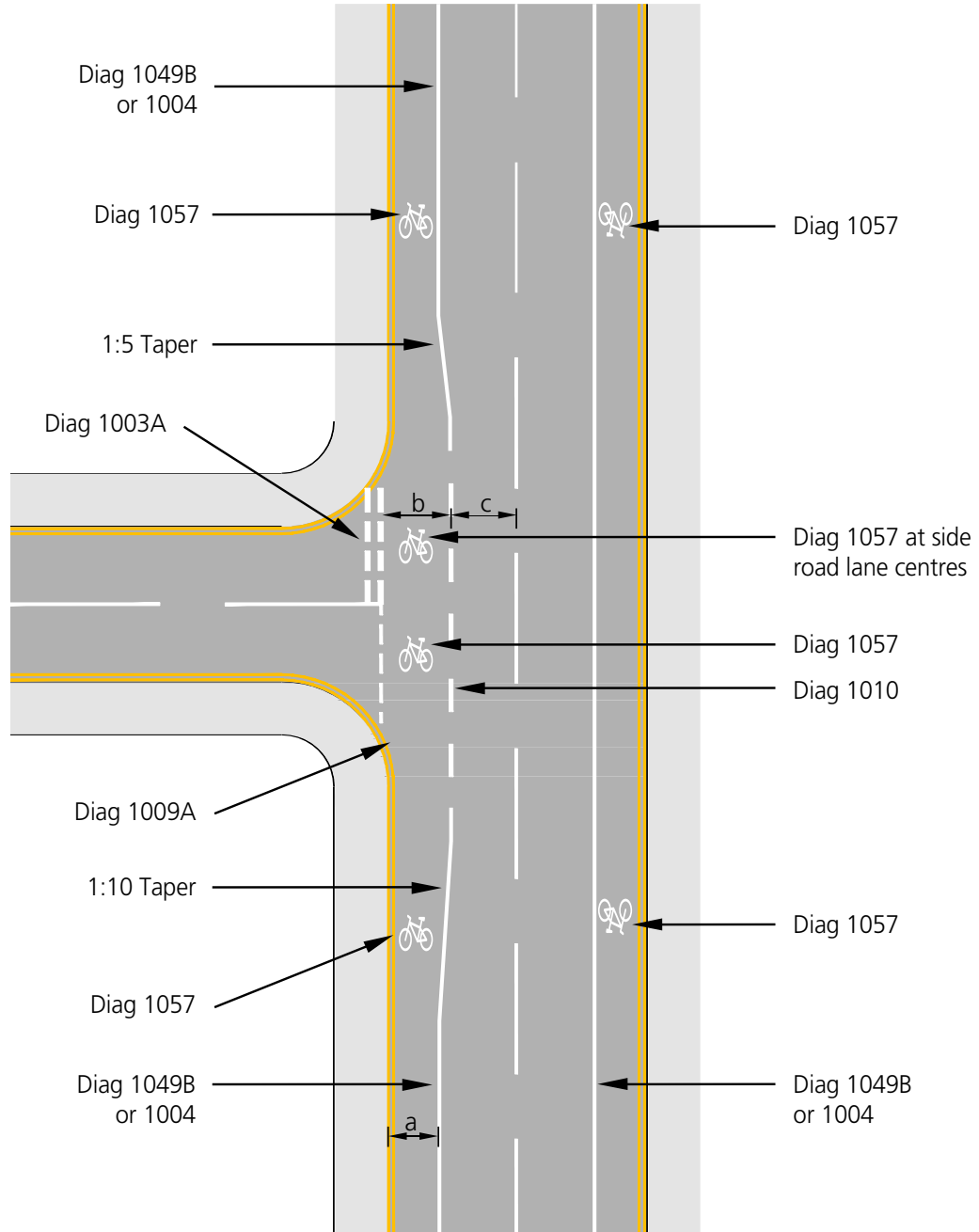

DE307 Cycle lanes with removal of centre lines

Measure and brief description

Consideration can be given to the removal of centre lines where carriageway widths do not permit the introduction of cycle lanes of adequate width whilst retaining two general traffic lanes. In addition to increasing the width available for cyclists, the technique also has a speed reducing effect as motor traffic no longer has defined lanes in each direction. Where the need arises for on-coming motor vehicles to pass each other on a narrow carriageway, this is achieved by both drivers momentarily pulling over into their respective near-side advisory cycle lanes, having first checked to see they are clear of cyclists.

Benefit

- Creates sufficient width for cycle lanes of the appropriate standard.
- Creates a safer and more comfortable environment than sub-standard cycle lanes.
- Achieves speed reduction for motor vehicles.
- Cost-effective, may be facilitated through maintenance works.
- Can be politically more acceptable than other more physical, traffic calming techniques.

Key design features

- Not suitable for roads with high traffic and HGV flows (maximum 10,000 AADT).
- Not suitable for roads with speed limits over 30mph.
- Unless only light vehicles are present, advisory cycle lanes should be used so that large vehicles can use the cycle lanes to pass one another.
- Requires adequate forward visibility.

Dimensions

- a – Desirable minimum 2.0m, Absolute minimum 1.5m.
- b – central general traffic lane 3m to 5.5m wide, preferably 4.1m – 4.8m.
- Where kerb-side parking is present, provide a buffer strip of 0.5 – 1m, or use inset parking bays.

Other considerations

- If the general traffic lanes are wider than 5.5m in total, the additional space should be used to increase the width of cycle lanes or provide a separated facility.

DE307

Cycle lanes with removal of centre lines

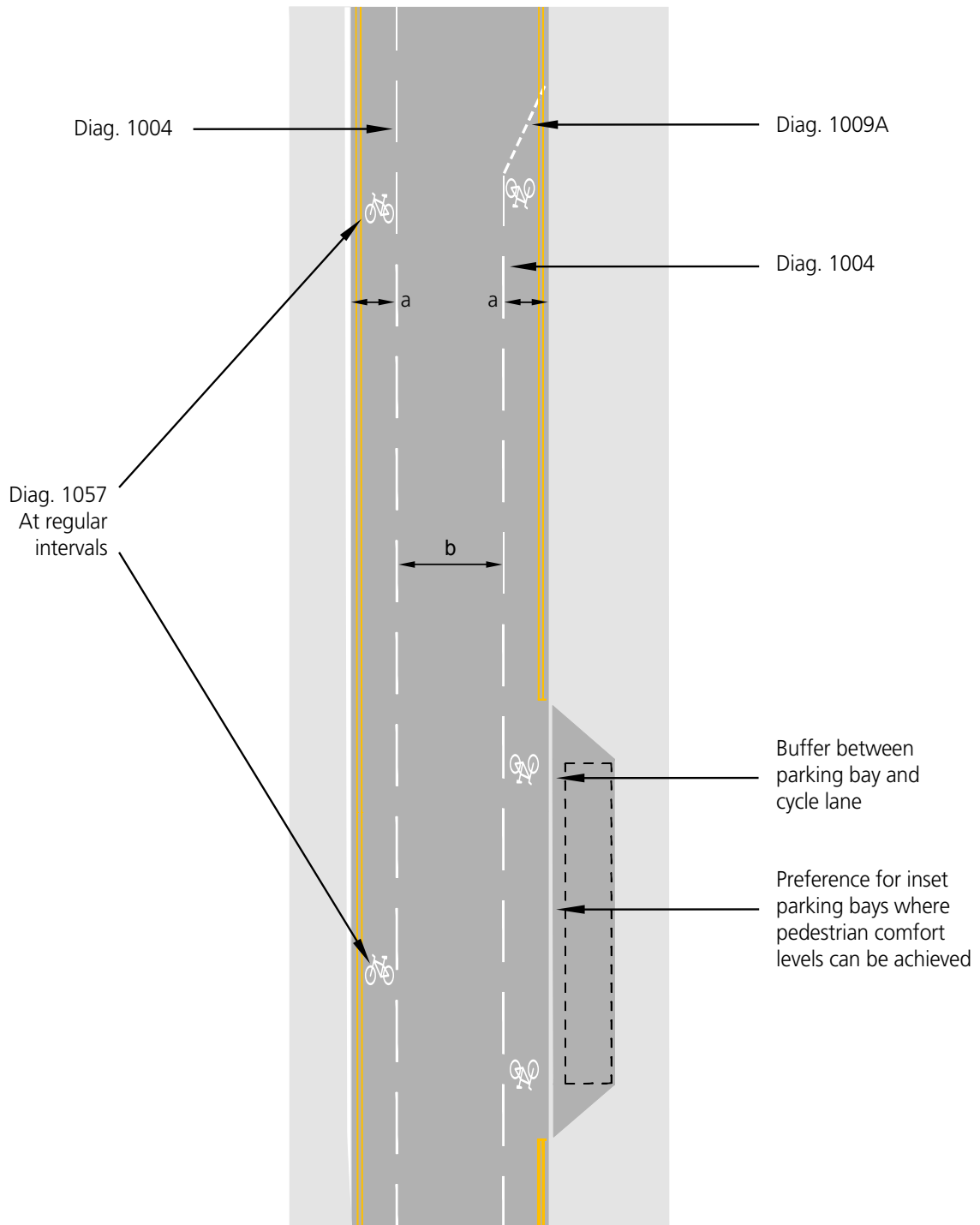
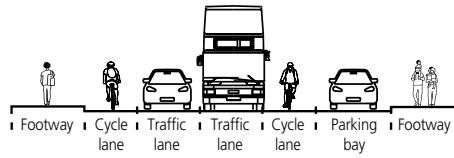

Llywodraeth Cymru
Welsh Government

DE number: DE307

Previous DE number: DE017

Do Not Scale Drawing

Revision number: 2

Copyright: Welsh Government

DE308 Cycle lane with light separation

Measure and brief description

A mandatory cycle lane may be reinforced by 'light separation' from the main carriageway to provide additional protection, i.e. intermittent physical features such as planters, wands (retroreflective self-righting bollards) or proprietary raised features which may be constructed from rubber, PVC or concrete. The fact that the obstacles are intermittent allows cyclists to manoeuvre between the cycle lane and the carriageway as necessary, avoids any impact on drainage and means that the design is cost effective and flexible.

Benefits

- Increase cyclist comfort and safety levels, as well as subjective safety.
- Can be used on roads with speed limits of up to 30mph.
- Physical features deter motorists from encroaching into lane.
- Cyclists can manoeuvre in and out of the lane to carry out right turns and for access
- Low installation cost.
- Easily installed to existing cycle lanes.
- Lane widths can be easily adapted to suit future conditions, such as increased usage.
- Can also be used for contra-flow lanes and for two way cycling.
- Avoids the need for drainage works.

Key design features

- Used in combination with a mandatory cycle lane (diagram 1049).
- Advisory cycle lane (diagram 1004) should not be used, as a key design principle is that motor vehicles should not cross light segregation.
- Physical features should be placed on the left-hand side of the cycle lane marking so that the marking can clearly be seen by drivers.
- Careful consideration is needed for the design of the physical feature – they need to be conspicuous and robust, but not mimic a road marking or sign.
- Continuity should be provided at bus stops.

Dimensions

- a – Desirable minimum 2.0m, Absolute minimum 1.5m.
- Where cycle flows are heavy (over 250 cyclists in the peak hour) and frequent overtaking occurs, widths should be increased to 2.5m.
- b – Segregation features to be spaced at 2.5-10m intervals, or as recommended by the product manufacturer.

Other considerations

- If using bollards consideration should be given for illumination or reflective strips.

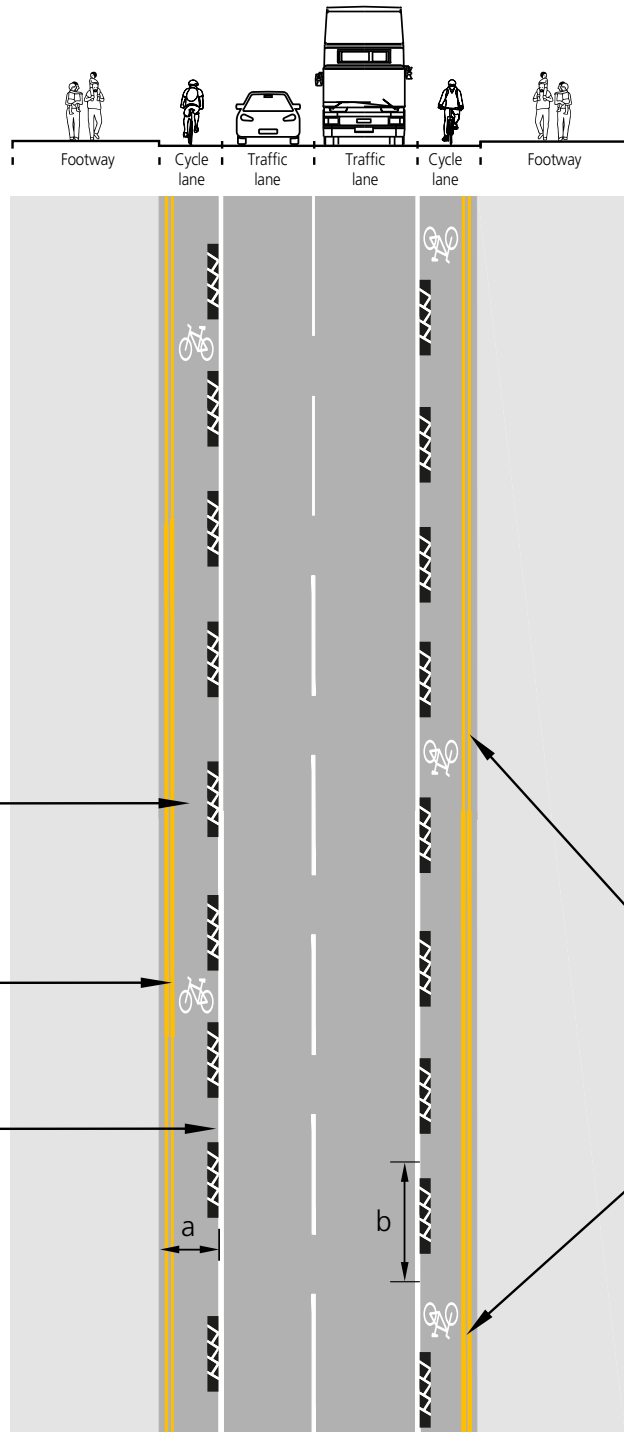

High level light separation feature

Diag. 1057

Diag. 1049B

Diag. 1057
At regular intervals



DE309 Cycle lane with light separation at side road

Measure and brief description

Cycle lanes with light segregation should continue across side road junctions to ensure continuity and help improve cycle safety. This can be achieved using a stretch of road marking diagram 1010, where the white line is broken, since continuous mandatory lanes across side road junctions are not permitted and in preference to advisory cycle lanes to diagram 1004.

Benefit

- Improves conspicuity of cyclists at conflict point.
- Provides route continuity.

Key design features

- Light separation feature does not continue across side road.
- The use of Diagram 1010 markings is recommended in preference to advisory cycle lanes to Diagram 1004 to increase conspicuity.
- Cycle symbols (Diagram 1057) may be placed in the cycle lane along the mouth of a junction.
- Coloured road surfacing may also be used in cycle lane to highlight the area of potential conflict.

Dimensions

- a – Width on approach – desirable minimum 2m, absolute minimum 1.5m.
- b – Width at side road should be at least 0.5m greater than on approaches.
- Separation features to be spaced at 2.5-10m intervals, or as recommended by the product manufacturer.
- Separation to cease no more than 5m from junction, depending on swept path requirements.

Other considerations

- Side road entry treatments (DE604) should also be considered, which provide raised carriageway tables and reduced corner radii at side road junctions. They help reduce turning vehicle speeds, making it safer and more accessible for cyclists passing through the junction and pedestrians crossing the side road.
- Entry to and from side roads should be reviewed to ensure appropriate sightlines and speeds to mitigate risks to cyclists from turning traffic.
- Side-road warning signs to Diagrams 962.1 or 963.1 to warn motorists and pedestrians respectively are generally unnecessary except for situations where contra-flow cycling is permitted.

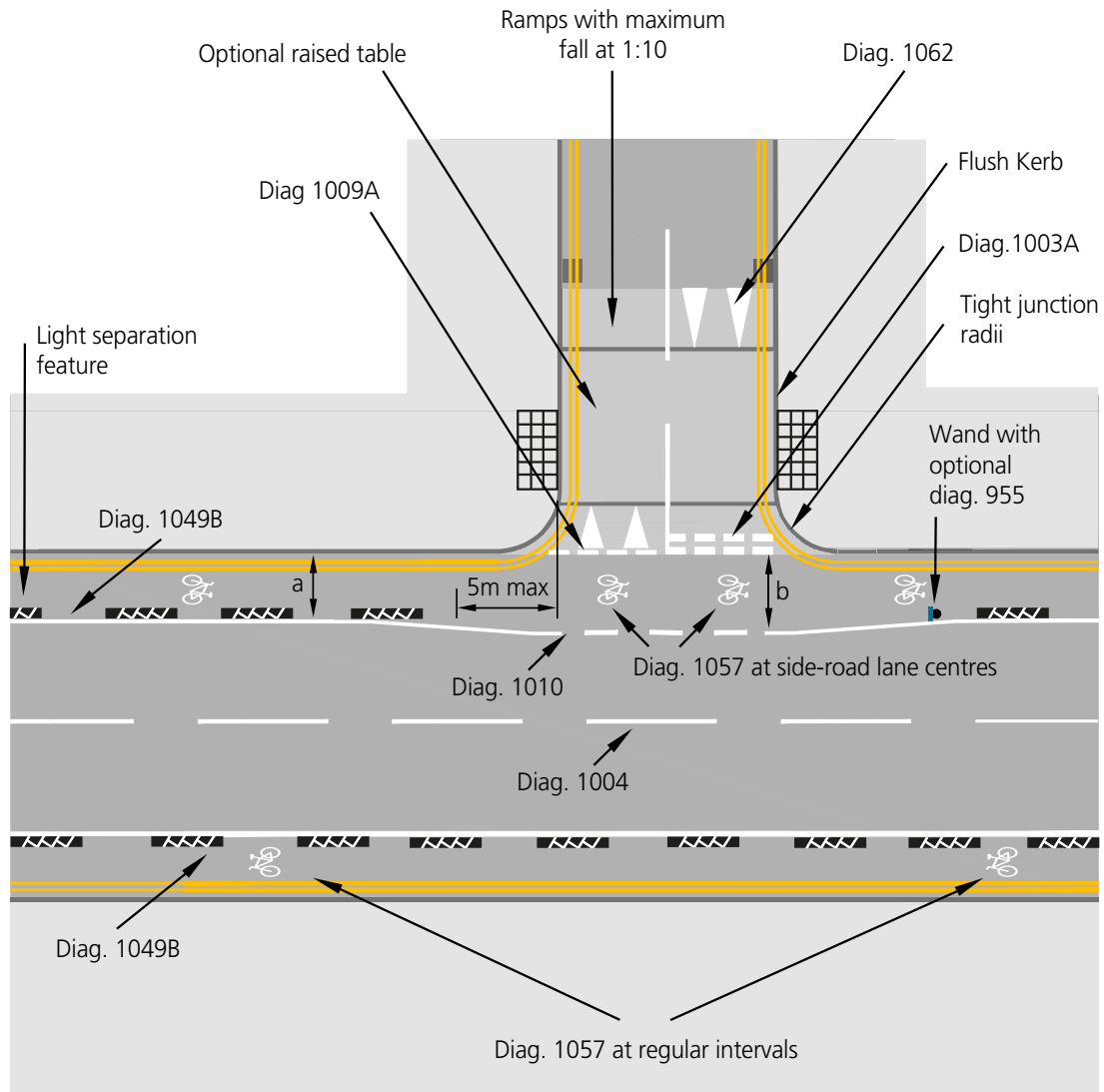

DE310 Car parking/loading with light separation

Measure and brief description

Car parking/loading may be provided on the carriageway side of cycle lanes with light separation, with a buffer strip between the edge of the lane and the car parking/loading. Parking/loading should be prohibited in the vicinity of side road junctions and accesses so as to maintain adequate intervisibility.

This detail can also be applied to stepped cycle tracks.

Benefit

- Provides cyclists with additional protection from moving traffic.
- Prevents parked cars causing obstruction to cycle lanes/tracks.
- Reduces likelihood and severity of cyclists being hit by vehicle doors opening.
- Prevents cyclists getting trapped at the start of parking bay.

Key design features

- Car parking located on the carriageway side of the cycle lane/track.
- Buffer strip to be provided between the edge of the cycle track and the parking/loading spaces.
- Car parking/loading to be prohibited on the approach to side roads/accesses, so approaching cyclists are clearly visible to traffic coming out of the side road/access.

Dimensions

- a – Desirable minimum 2.0m, absolute minimum 1.5m.
- b – Buffer strip minimum width 0.5m.
- 1:10 entry taper and 1:5 exit taper.
- Separation features to be spaced at 2.5-10.0m intervals, or as recommended by the product manufacturer.

Other considerations

- A 2.0m wide cycle track can be reduced locally to 1.5m to allow a 0.5m wide dividing strip to be provided.

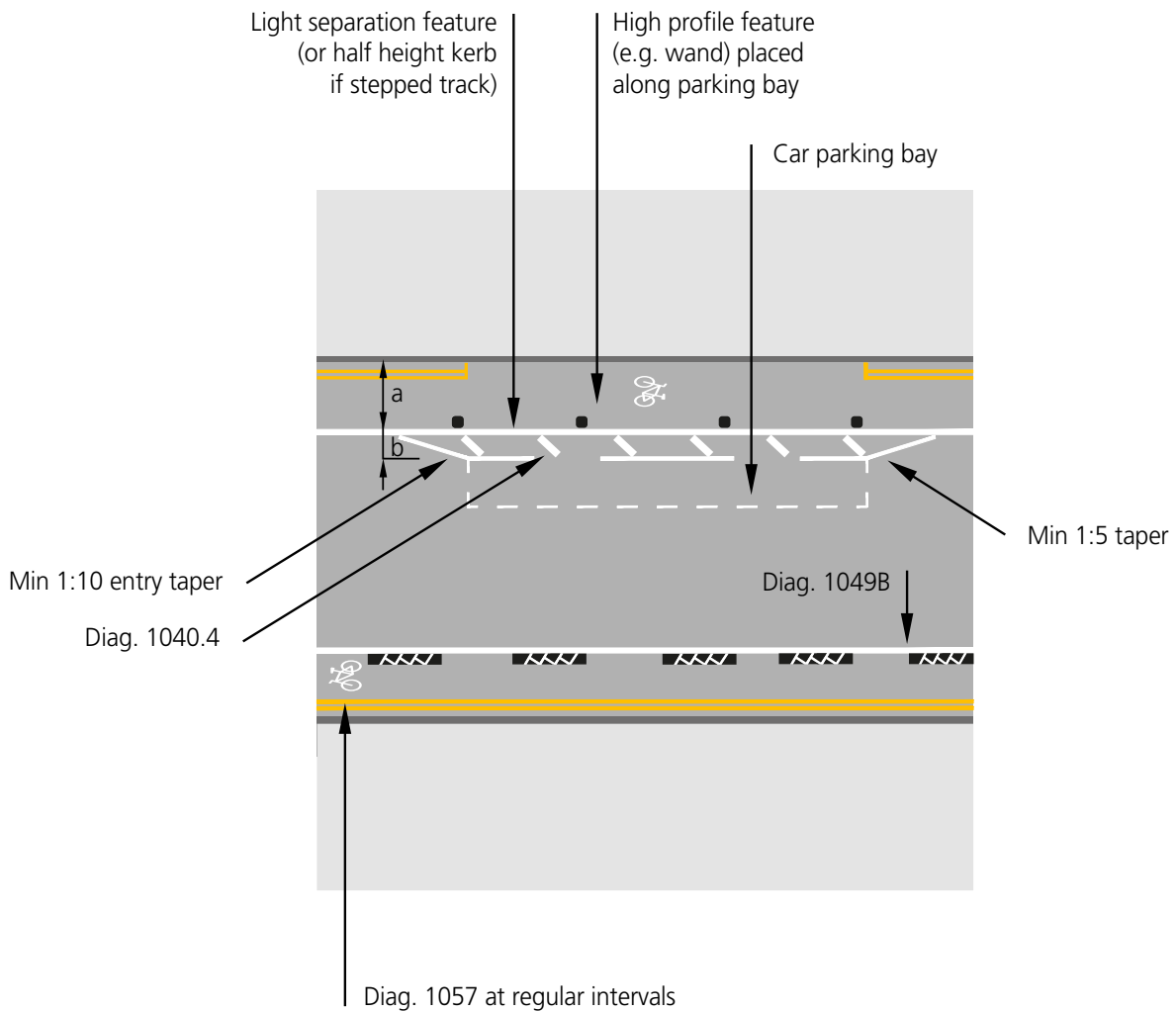

DE311 Stepped cycle track

Measure and brief description

Stepped cycle tracks have a surface raised above the carriageway but are below the level of the footway. They keep cyclists close to other traffic but provide more separation from it than a cycle lane or light separation does. Cyclists can enter and leave the cycle track relatively easily where lowered kerbs or fillets are provided but the presence of a raised kerb edge along most of the length deters encroachment by motor vehicles.

Benefit

- Increases cyclist comfort and safety levels, as well as subjective safety.
- Can be used on roads with speed limits of up to 30mph.
- Level difference helps deter motorists from straying into cycle lane.
- Priority for cyclists over accesses to properties and side roads is maintained.
- Can reduce the amount of traffic signs and markings compared with mandatory cycle lanes.
- No TRO is required although this would be necessary for parking restrictions.
- Can reduce conflict between cyclists and pedestrians compared with shared use paths.

Key design features

- Stepped cycle tracks operate one way, in the same direction as motor traffic flow.
- Cycle tracks will be provided through reallocation of road space from the carriageway or verge in preference to reducing footway widths.
- Lowered to merge with the carriageway at junctions or other areas where cyclists need to access the general traffic lanes.
- Continuity should be provided at bus stops.
- Stepped tracks at side roads retain priority for cyclists.

Dimensions

- a – Desirable minimum 2.0m, Absolute minimum 1.5m.
- Where cycle flows are heavy (over 250 cyclists in the peak hour) and frequent overtaking occurs, widths should be increased to 2.5m.
- Minimum kerb upstands should generally be 50mm on the carriageway side, and 25mm on the footway side.
- Lamp columns, sign posts, etc should be placed 0.5m from any stepped cycle lane.

Other considerations

- New drainage facilities will need to be introduced into the narrowed carriageway while existing grates will need to be raised to cycle track level. Cycle friendly drainage grates should be used for both.
- Can be used as part of centre line removal projects.
- There is no particular requirement to sign stepped tracks (or use coloured surfacing). In many cases, the kerb upstand itself will suffice to deter motor vehicles from entering. However, the use of a mandatory lane placed on the carriageway side of the kerb could be considered if encroachment by motor vehicles (including parking) becomes a problem.
- See DE312 for details of Stepped Cycle Tracks at Side Roads.

DE311

Stepped cycle track

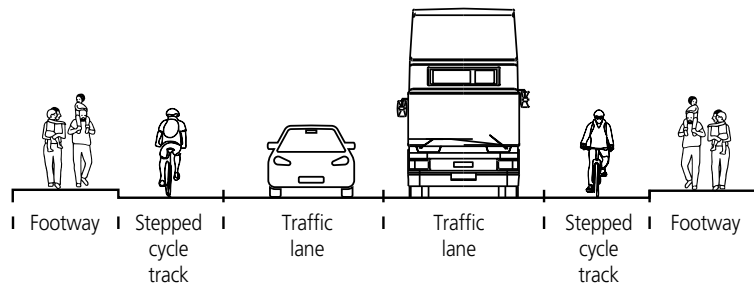

Diag 1057

Diag 1004

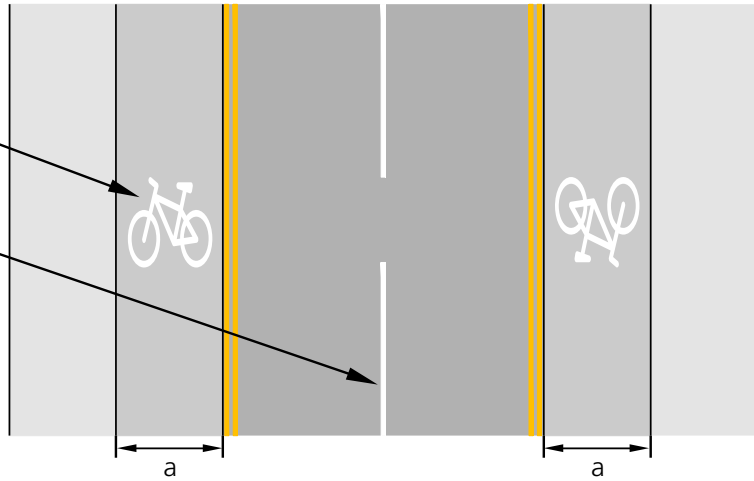

Llywodraeth Cymru
Welsh Government

DE number: DE311

Previous DE number: DE021

Do Not Scale Drawing

Revision number: 2

Copyright: Welsh Government

DE312 Stepped cycle track at side road

Measure and brief description

Stepped tracks are still considered part of the carriageway, and normally operate one-way in the same direction as general traffic, they should cross side roads in the same position as a cycle lane, ensuring route continuity. One-way stepped tracks should normally retain priority over side roads, this can be achieved by:

- Continuing the track through the junction with a flush kerb;
- Stopping the stepped track within 5.0m of the junction on either side with a raised crossing for turning traffic and tight corner radii at the side road; or
- By the stepped track transitioning to a cycle lane 20m -30m in advance of the side road (in which case refer to DE306).

Benefits

- Helps the conspicuity of cyclists at conflict point.
- Helps with route continuity.

Key design features

- Side road give-way markings should be set back from the cycle track.
- Cycle symbols (Diagram 1057) may be placed in the cycle track/lane across the mouth of a junction.
- Coloured road surfacing may also be used in cycle track/lane to highlight the area of potential conflict.
- Care needs to be taken where stepped tracks pass private accesses, to ensure drivers emerging from the access can see cyclists. Cyclists should not normally be required to give way to vehicles using accesses.

Dimensions

- a – Width on approach - desirable minimum 2.0m, absolute minimum 1.5m.

Other considerations

- Side road entry treatments (DE604) should also be considered, which provide raised carriageway tables and reduced corner radii at side road junctions. They help reduce turning vehicle speeds, making it safer and more accessible for cyclists passing through the junction and pedestrians crossing the side road.
- Entry to and from side roads should be reviewed to ensure appropriate sightlines and speeds to mitigate risks to cyclists from turning traffic.
- Side-road warning signs to Diagrams 962.1 or 963.1 to warn motorists and pedestrians respectively are generally unnecessary except for situations where contra-flow cycling is permitted.
- Widening of the cycle lane at the junction can also be considered, as per DE306.

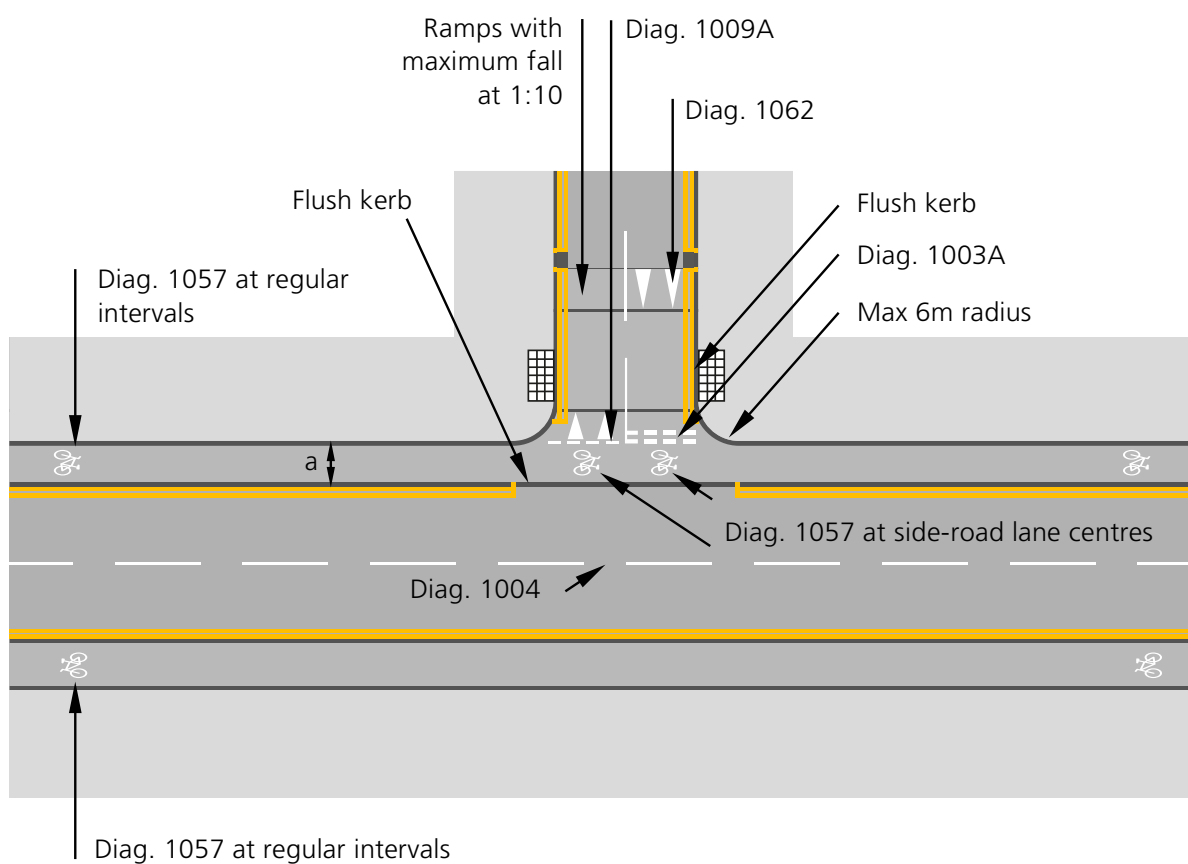

DE313 Cycle track alongside road, separated from pedestrians

Measure and brief description

Where traffic volumes and/or speeds are too high for cycle lanes, light separation or stepped tracks, physical separation from motor traffic may be appropriate to provide cyclists with safe and comfortable space, through the provision of separate cycle tracks and footways. Cycle tracks will be provided through reallocation of road space from the carriageway or verge in preference to reducing footway widths.

Physical separation from pedestrians is generally preferred where widths can be achieved, using a level difference or verge. Barriers between cycle tracks and footways are not desirable because they limit the effective width of the paths and can be hazardous. Separation using only simple white lines (Diag 1049) is not detectable for blind users. A raised white line delineator (Diag 1049.1), is an option that may be acceptable alongside faster and busier main roads where there is plenty of space and demand is light. Where demand is likely to be greater, it is preferable to use a stepped track (see DE311 and DE312).

Benefits

- Provides routes which are free from conflict with motor traffic.
- Separated paths allow each group to move at their own desired pace and improve comfort and subjective safety.

Key design features

- The cycle track should normally be located between carriageway and footway.
- Footways and cycle tracks should be continuous across private accesses.
- Pedestrians require regular crossing points with flush kerbs between the cycle track and the carriageway; tactile paving should be provided.
- Cycle tracks should not deflect more than 45° and changes in height should be avoided.
- Machine-laid black bituminous surfacing should be used as it will make cycle journeys safer, more comfortable and helps distinguish cycle tracks from adjacent footways surfaced by pavements or slabs.
- Lamp columns, sign posts and other street furniture should not be placed in cycle tracks.
- Centre lines should be marked on two-way cycle tracks.

Dimensions

- a – Cycle track width (two-way) should be sufficient to accommodate the forecast level of use with a minimum of:
 - » Absolute minimum 2.5m, where the peak hour cycle flow is less than 50/hr;
 - » Desirable minimum 3m, where it is 50-250/hr, 4.0m for cycle flows over 250/hr. Cycle tracks should include additional width where they are bounded by vertical features. Additional width required is:
 - » Kerb up to 150mm high: add 200mm.
 - » Vertical feature 150-600mm high: add 250mm.
 - » Vertical feature above 600mm high: add 500mm.
- b – In addition to the path width above, a margin strip separating the cycle track from the carriageway is recommended:
 - » Desirable minimum 0.5m with speed limits of 30mph
 - » Desirable minimum 1.5m with speed limits of 40mph or above.

- c – The width of the footway should reflect the level and type of use, based on level of service, Desirable minimum 2.0m width, increasing to 3.5m width where there is frequent use by groups. 1.5m may be acceptable over short lengths – see DE101.
- If a verge is used to separate pedestrian and cycle routes it should be a minimum of 1.0m wide to enable mowing.

Other considerations

- Generally cycle tracks alongside the carriageway will either be two-way, usually on one side of the road, or one-way on both sides of the road. Historically most cycle tracks in the UK have been built as two-way, but this can present safety problems at junctions.
- Care needs to be taken where a cycle track passes private accesses, to ensure drivers emerging from the access can see cyclists.
- Two-way tracks are therefore best suited to routes that have few side road junctions and accesses.
- Use of white lining to provide a buffer between the cycle track and carriageway is not recommended in unlit areas, as this could be misinterpreted as marking the edge of carriageway by passing motorists, who are then at risk of striking the kerb and losing control.
- Upright signs to indicate cycle track should preferably be located in the verge or footway, without compromising width for pedestrians.

DE313

Cycle track alongside road, separated from pedestrians

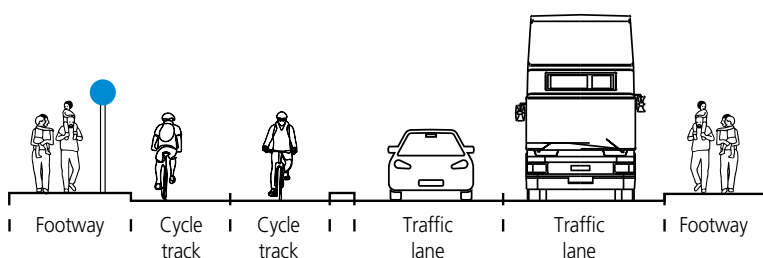

Diag 955 mounted back to back and Diag 1057 to be located at start of cycle track but must not compromise space for pedestrians

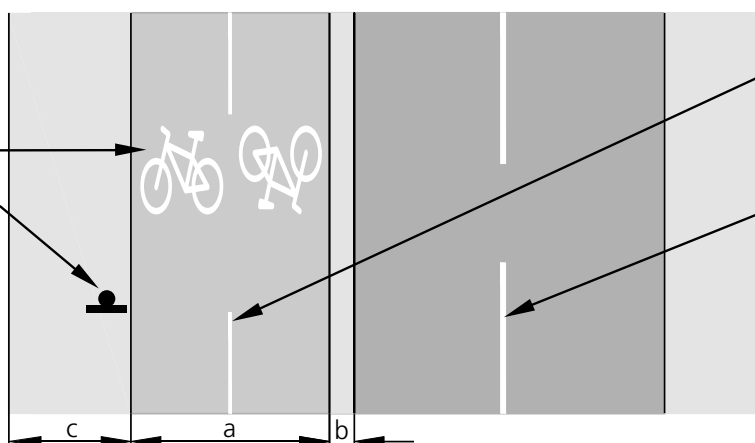

Diag 1008 (50mm)
(to be omitted if cycle track < 3.0m)

Diag 1004

c

a

b



Llywodraeth Cymru
Welsh Government

DE number: DE313

Previous DE number: DE023

Do Not Scale Drawing

Revision number: 2

Copyright: Welsh Government

DE314 Two-way cycle track in centre of carriageway

Measure and brief description

Two-way cycle tracks in the centre of the carriageway can offer a good level of service. Cyclists are in a highly visible location which has no conflict with parked vehicles, bus stops or loading, or vehicles turning into and out of left in/left out side road junctions or accesses. Access to the track (at each end and along its length) can be via priority or signal controlled crossings, or signal controlled junctions with cycle stages. Where motor traffic volumes are not high mini or compact roundabouts are also an option, since cyclists will be arriving into and leaving from the junction in a dominant position.

Benefits

- No conflict with kerbside activity.
- High profile facility.

Key design features

- Two-way cycle track should be protected with kerb upstands or with light separation.
- Tracks can be provided in wide central reservations, including on higher speed roads.
- Similarly, one-way light-segregated lanes, stepped tracks or tracks can be provided adjacent to the central reservation on dual carriageways.
- Cycle priority to be maintained across any lightly-trafficked central reservation gaps.
- U-turns at central reservation gaps should be banned.

Dimensions

- Cycle track width should be sufficient to accommodate the forecast level of cycle use with a minimum of:
 - » Absolute minimum 2.5m, where the peak hour cycle flow is less than 50/hr;
 - » Desirable minimum 3.0m, where the peak hour cycle flow is 50-250/hr, 4.0m for peak hour cycle flows over 250/hr.
 - » In addition to the path width above, a margin strip separating the cycle track from the carriageway is recommended:
 - » Desirable minimum 0.5m with speed limits of 30mph
 - » Desirable minimum 1.5m with speeds limits of 40mph or above.

Other considerations

- Provision should be made for pedestrians crossing movements at regular intervals.
- Difficulties in joining or leaving the track at points along it mean this arrangement is unlikely to be suitable for roads with many destinations along them (e.g. shopping streets) or with frequent side-road junctions, unless the traffic is light and/or very slow-moving.

DE314

Two-way cycle track in centre of carriageway

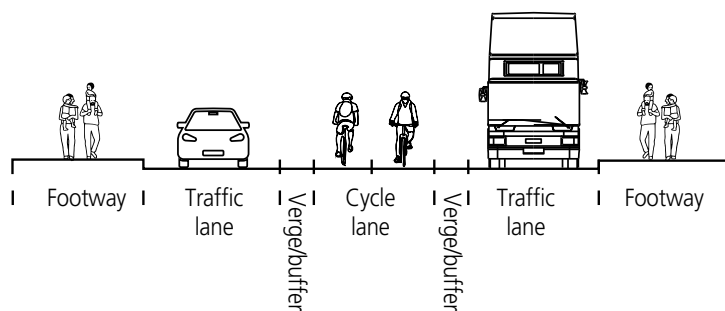

Diag. 1057
at regular
intervals

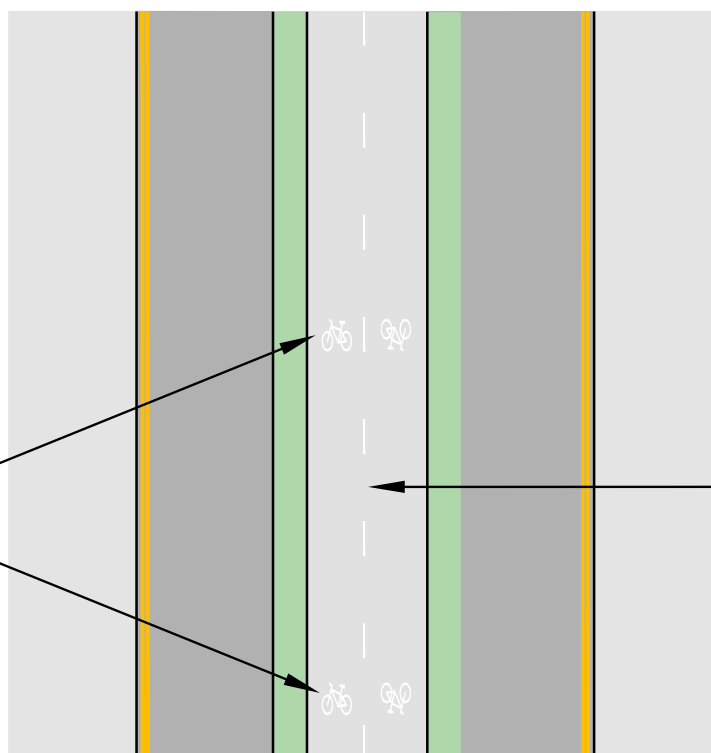

Diag. 1008
(50mm)



Llywodraeth Cymru
Welsh Government

DE number: DE314

Previous DE number: DE027

Do Not Scale Drawing

Revision number: 2

Copyright: Welsh Government

DE315 Transition between carriageway and cycle track

Measure and brief description

'Merge' transitions involve cyclists joining the carriageway, a cycle lane, light segregated lane or stepped track, from an traffic-free cycle track. At 'diverge' transitions, cyclists carry out the reverse manoeuvre to join a parallel cycle track. The design of these transitions should provide a direct route for cyclists which does not require them to deviate significantly from their direction of travel, nor cross a kerb at an angle. At merges they should not need to give way to general traffic and be given space free from motor vehicles to enter into, defined by a cycle lane, light segregation or a stepped track. The design should ensure that cyclists are clearly visible to motorists and that motorists are aware that cyclists are likely to be re-joining the carriageway.

As well as providing transitions between on and off-road facilities along links, these transitions can be used on the approaches to controlled crossings or junctions to enable cyclists to leave the carriageway to use a facility. The design should minimise any conflict with pedestrians and other cyclists waiting at the crossing point.

Benefits

- A smooth transition when joining or leaving the carriageway, without the need to give way or stop, will make a facility more comfortable and safe.

Key design features

- Build-outs can be used to push vehicles away from cyclists rejoining the carriageway.
- Designs should take account of cyclists who are already using the carriageway at the merge point.
- Cyclists leaving the carriageway should not be brought into conflict with pedestrians.
- Cyclists should cross any kerbs at 90 degrees and these should be flush.
- Any tapers should be no sharper than 1:10.

Dimensions

- a – Width - desirable minimum 2m, absolute minimum 1.5m.
- b – Desirable margin strip separating cycle track from carriageway 0.5-1.0m.
- c – The width of the footway should reflect the level and type of use, based on level of service, Desirable minimum 2m width, increasing to 3.5m width where there is frequent use by groups. 1.5m may be acceptable over short lengths – see DE101.

Other considerations

- Transition to carriageway should be flush with no upstand.
- It is preferable to continue the cycle lane with light segregation, even if only for a short section, not least because this prevents the exit-point from the cycle track from being blocked by parked vehicles.

DE315

Transition between carriageway and cycle track

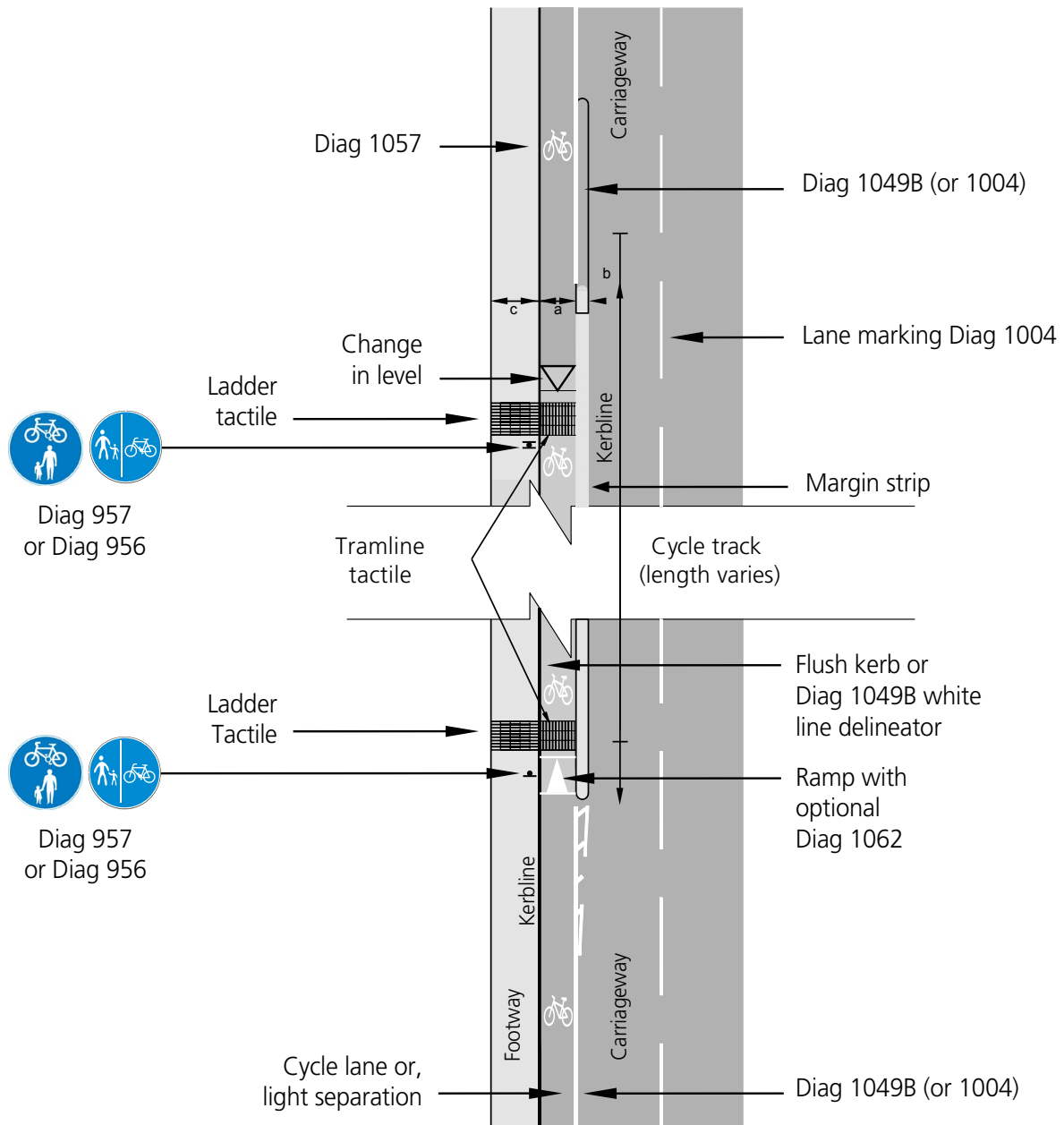

Llywodraeth Cymru
Welsh Government

DE number: DE315

Previous DE number: DE034

Do Not Scale Drawing

Revision number: 2

Copyright: Welsh Government

DE401 Shared pedestrian and cycle track, alongside road

Measure and brief description

Where traffic volumes and/or speeds are too high for cycle lanes, light segregation or stepped tracks, physical separation from motor traffic may be appropriate to provide cyclists with safe and comfortable space. Where a cycle track will be shared with pedestrians, sufficient width must be provided for the two user groups to interact safely and in comfort. It is essential that developing the design of an unsegregated shared use track includes early consultation with relevant interested parties such as those representing people with disabilities, pedestrians and cyclists. In most urban locations the conversion of footways to unsegregated shared use should be avoided.

Key design features

- Shared cycle tracks should be continuous across private accesses.
- Pedestrians require regular crossing points with flush kerbs; tactile paving should be provided.
- Cycle tracks should not deflect more than 45° and changes in height should be avoided.
- Machine-laid bituminous surfacing should be used as it will make cycle journeys safer, more comfortable and helps distinguish shared cycle tracks from nearby footways surfaced by pavements or slabs.
- Lamp columns and other street furniture should not be placed in cycle tracks.

Dimensions

- a – width should reflect the level and type of use forecast with a minimum of 3.0m width on primary cycle routes, or 2.5m on less busy secondary routes. On particularly heavily trafficked routes it should be increased to 4.5m.
- Unsegregated cycle tracks should include additional width where they are bounded by vertical features. Additional width required is:
 - » Kerb up to 150mm high: add 200mm;
 - » Vertical feature 150-600mm high: add 250mm;
 - » Vertical feature above 600mm high: add 500mm.
- b – in addition to the path width above, a margin strip separating the cycle track from the carriageway is recommended:
 - » Desirable minimum 0.5m with speed limits of 30mph;
 - » Desirable minimum 1.5m with speed limits of 40mph or above.

Other considerations

- Generally cycle tracks alongside the carriageway will either be two-way, usually on one side of the road, or one-way on both sides of the road. Historically most cycle tracks in the UK have been built as two-way, but this can present safety problems at junctions.
- Care needs to be taken where a cycle track passes private accesses, to ensure drivers emerging from the access can see cyclists.
- Two-way tracks are therefore best suited to routes that have few side road junctions and accesses.
- Use of white lining to provide a buffer is not recommended in unlit areas, as this could be misinterpreted as marking the edge of carriageway by passing motorists, who are then at risk of striking the kerb and losing control.
- Upright signs to indicate cycle track should preferably be located in any verge between the cycle track and the carriageway. Lamp columns and other street furniture should be set back at least 0.5m from the edge of the pedestrian/cycle track.

DE401

Shared pedestrian and cycle track, alongside road

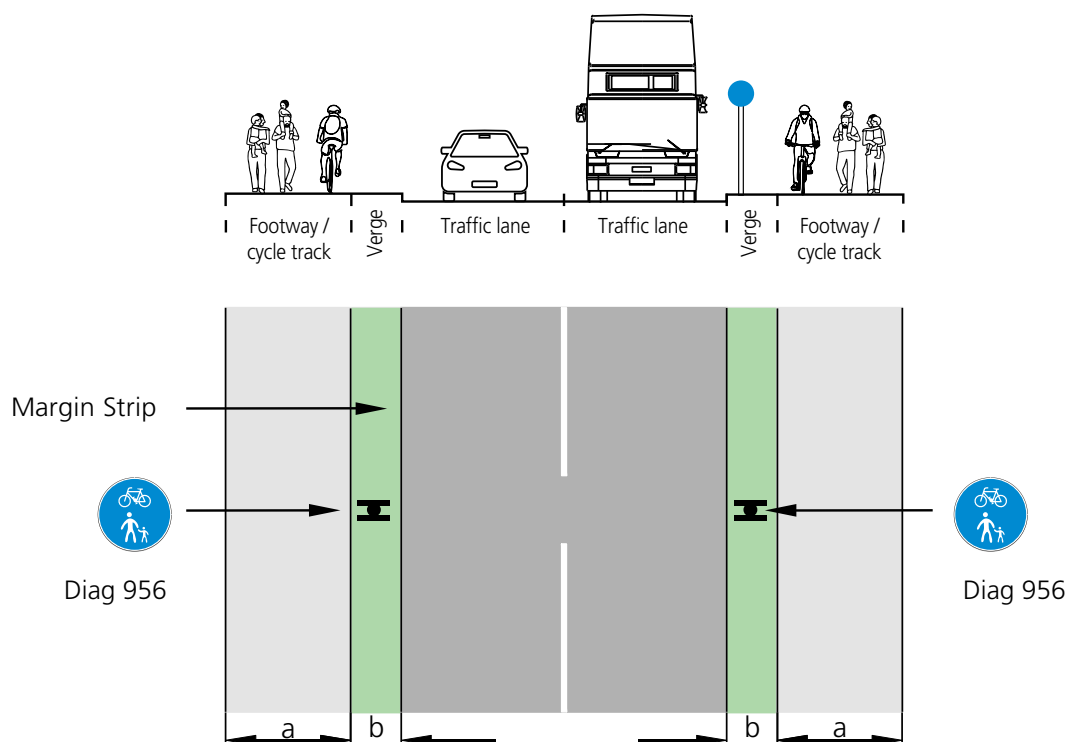

Llywodraeth Cymru
Welsh Government

DE number: DE401

Previous DE number: DE024

Do Not Scale Drawing

Revision number: 3

Copyright: Welsh Government

DE402 Separated pedestrian and cycle track, away from road

Measure and brief description

Routes away from the road can provide a very good quality link for both pedestrians and cyclists. A separate parallel path for pedestrians is desirable, and sufficient width should be provided for each user group so that they do not encroach on the other users' path.

Physical segregation is generally preferred provided widths are adequate and this can be through a level difference or verge. Barriers are not desirable since they limit the effective width of the paths and are a particular hazard to cyclists. Segregation using only simple white lines (Diag 1049) (which are not detectable by blind users) or a raised white line delineator (Diag 1049.1), is an option but it is rarely respected by pedestrians (who have the legal right to use the cycle track) in practice, unless cycle flows are high or there is generous width, and should be avoided.

Benefits

- Provides routes which are free from conflict with motor traffic.
- Segregated paths allow each group to move at their own desired pace and improve comfort and subjective safety.

Key design features

- Footpaths and cycle tracks should be continuous.
- Flush kerbs with tactile paving at priority crossings.
- Cycle tracks should not deflect more than 45° from cyclists' desire line and changes in height should be avoided.
- Machine-laid black bituminous surfacing should be used as it will make cycle journeys safer, more comfortable and helps distinguish cycle tracks from adjacent footways surfaced by pavements or slabs.

Dimensions

- a – the width for pedestrians should reflect the level and type of use forecast with an absolute minimum of 2.0m, increasing to a desirable minimum of 3.5m where there is frequent use by groups. 1.5m may be acceptable over short lengths, however – see DE101.
- b – cycle track width should be sufficient to accommodate the forecast level of use with a minimum of:
 - » Absolute minimum 2.5m, where the peak hour flow is less than 50/hr;
 - » Desirable minimum 3.0m, where it is 50-250/hr, 4.5m for cycle flows over 250/hr.
- Cycle tracks should include additional width where they are bounded by vertical features. Additional width required is:
 - » Kerb up to 150mm high: add 200mm.
 - » Vertical feature 150-600mm high: add 250mm.
 - » Vertical feature above 600mm high: add 500mm.
- Verges separating pedestrian and cycle routes should be a minimum of 1.0m wide.

Other considerations

- Generally cycle tracks will be two-way.
- Centre lines should be marked on two-way cycle tracks.
- Lamp columns and other street furniture should be set back at least 0.5m from the edge of either track.
- Path geometry, particularly radii, forward visibility and gradient, should reflect the user need criteria set out in chapter 9.
- Paths used for utility journeys (all Active Travel Routes) should normally be lit.
- Access control features should not be installed.

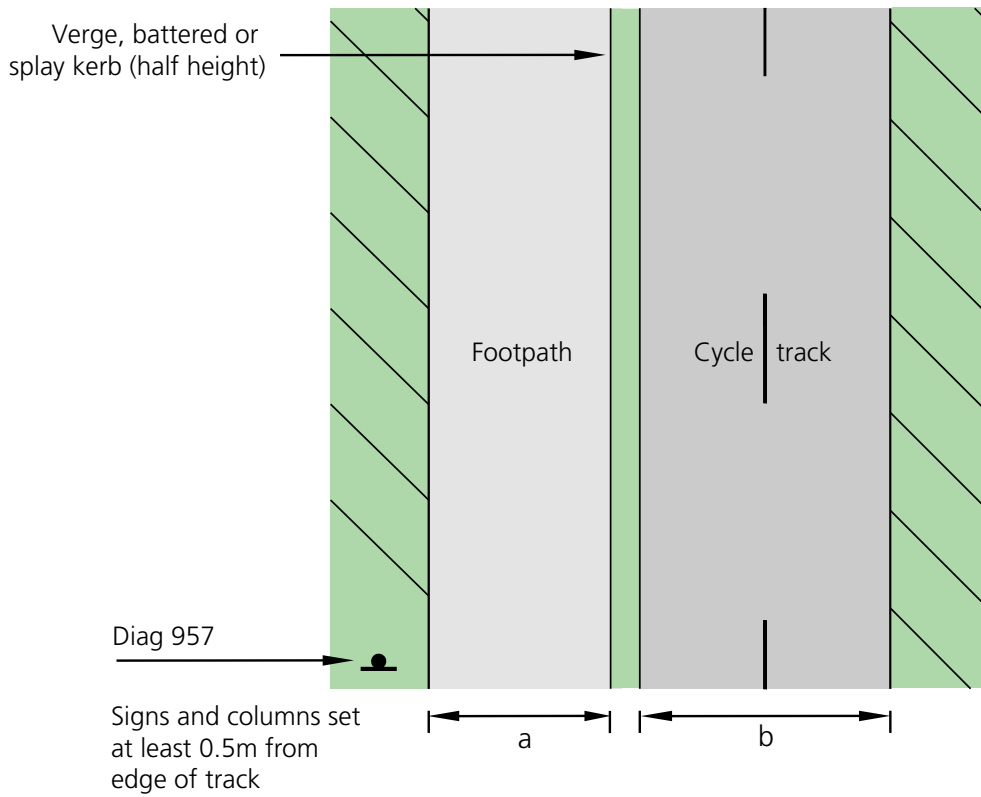

DE403 Shared pedestrian and cycle track, away from road

Measure and brief description

Routes away from the road can provide a very good quality link for both pedestrians and cyclists. Where a cycle track will be shared with pedestrians, sufficient width must be provided for the two user groups to interact safely and in comfort. The design of an unsegregated shared use track should include early consultation with relevant interested parties such as those representing people with disabilities, walkers and cyclists.

Key design features

- Footpaths and cycle tracks should be continuous.
- Flush kerbs with tactile paving at priority road crossings.
- Cycle tracks should not deflect more than 45° from cyclists' desire line and constant changes in height should be avoided
- Machine-laid bituminous surfacing should be used as it will make journeys safer and more comfortable.

Dimensions

- a – width should reflect the level and type of use forecast with a minimum of 3m width on primary cycle routes, or 2.5m on less busy secondary routes. On particularly heavily trafficked routes it should be increased to 4.5m.
- Shared use cycle tracks should include additional width where they are bounded by vertical features. Only where there is open space on both sides is it practical to use the whole track width to cycle. Additional width required is:
 - » Kerb up to 150mm high: add 200mm;
 - » Vertical feature 150-600mm high: add 250mm;
 - » Vertical feature above 600mm high: add 500mm.
- Where possible clear verges (1m wide) should be provided alongside pedestrian and cycle routes.

Other considerations

- Lamp columns and other street furniture should be set back at least 0.5m from the edge of the track.
- Path geometry, particularly radii, forward visibility and gradient, should reflect the user need criteria set out in chapter 9.
- Paths used for utility journeys (all Active Travel Routes) should normally be lit.
- Access control features should not be installed.
- The British Horse Society recommends a desirable minimum width of 5.0m for new bridleways, which would be shared with pedestrians and cyclists.

DE403

Shared pedestrian and cycle track, away from road

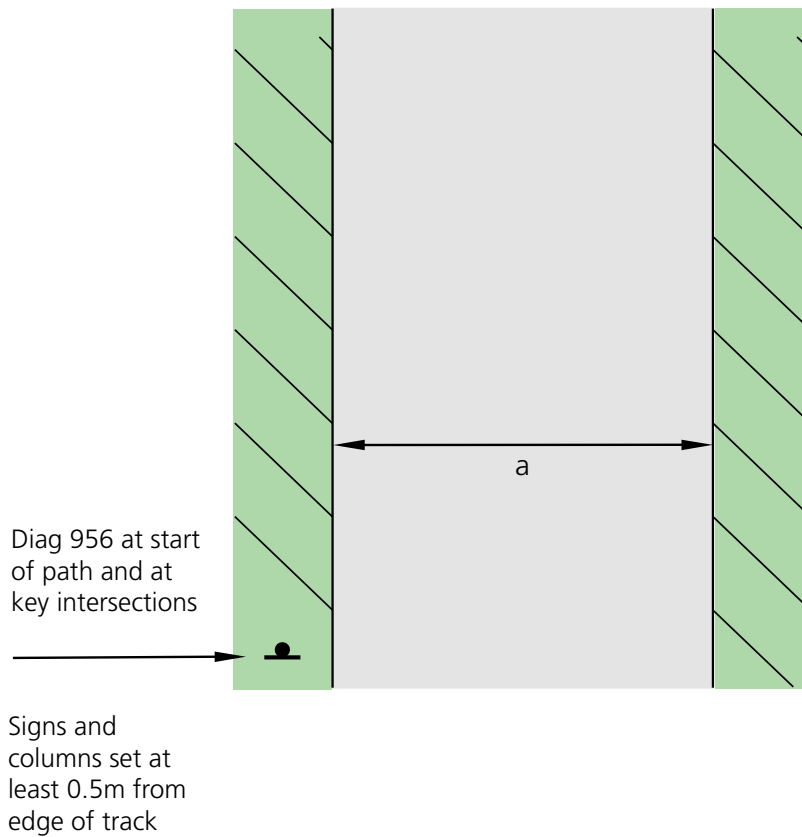

Llywodraeth Cymru
Welsh Government

DE number: DE403

Previous DE number: DE033

Do Not Scale Drawing

Revision number: 3

Copyright: Welsh Government

DE501 Bus stop: cycle lane bypass

Measure and brief description

Cyclists should be enabled to pass stationary buses so that they can maintain momentum and minimise delay. TSRGD advises that where cycle lanes in the usual position next to the kerb encounter bus stops they should be terminated and begin again after the bus cage. This requires cyclists to move out into general traffic, which does not meet their needs.

The provision of a cycle lane bypass around the bus stop provides a preferable solution. This design is best suited to urban areas where traffic speeds are below 30mph, and where bus frequency is high (more than 6 buses per hour) or bus stops are occupied for 15 min per hour or more.

Benefits

- Maintains route continuity.
- Cycle lane around the bus stop cage (on carriageway yellow bus stop markings) reduces the risk of collision with traffic when a cyclist overtakes a stationary bus.
- It provides space between an overtaking cyclist and a stationary bus.
- Best suited at bus stops with high passenger numbers and high bus frequency.

Key design features

- Marked route for cyclists bypasses bus cage.
- Sufficient width for cycle lane and buffer strip past bus cage.

Dimensions

- a – Desirable minimum 2.0m, Absolute minimum 1.5m.
- b – general traffic or bus lane width 3.0m Desirable minimum.
- c – bus cage width Desirable minimum 3.0m, Absolute minimum 2.7m.
- d – buffer strip - Desirable minimum 1m, Absolute minimum 0.75m.

Other considerations

- Also compatible with one-way light separated cycle lanes and stepped tracks, which become cycle lanes past the bus stop.
- Variants of this design can be considered where buses are provided with full or half width bus laybys.

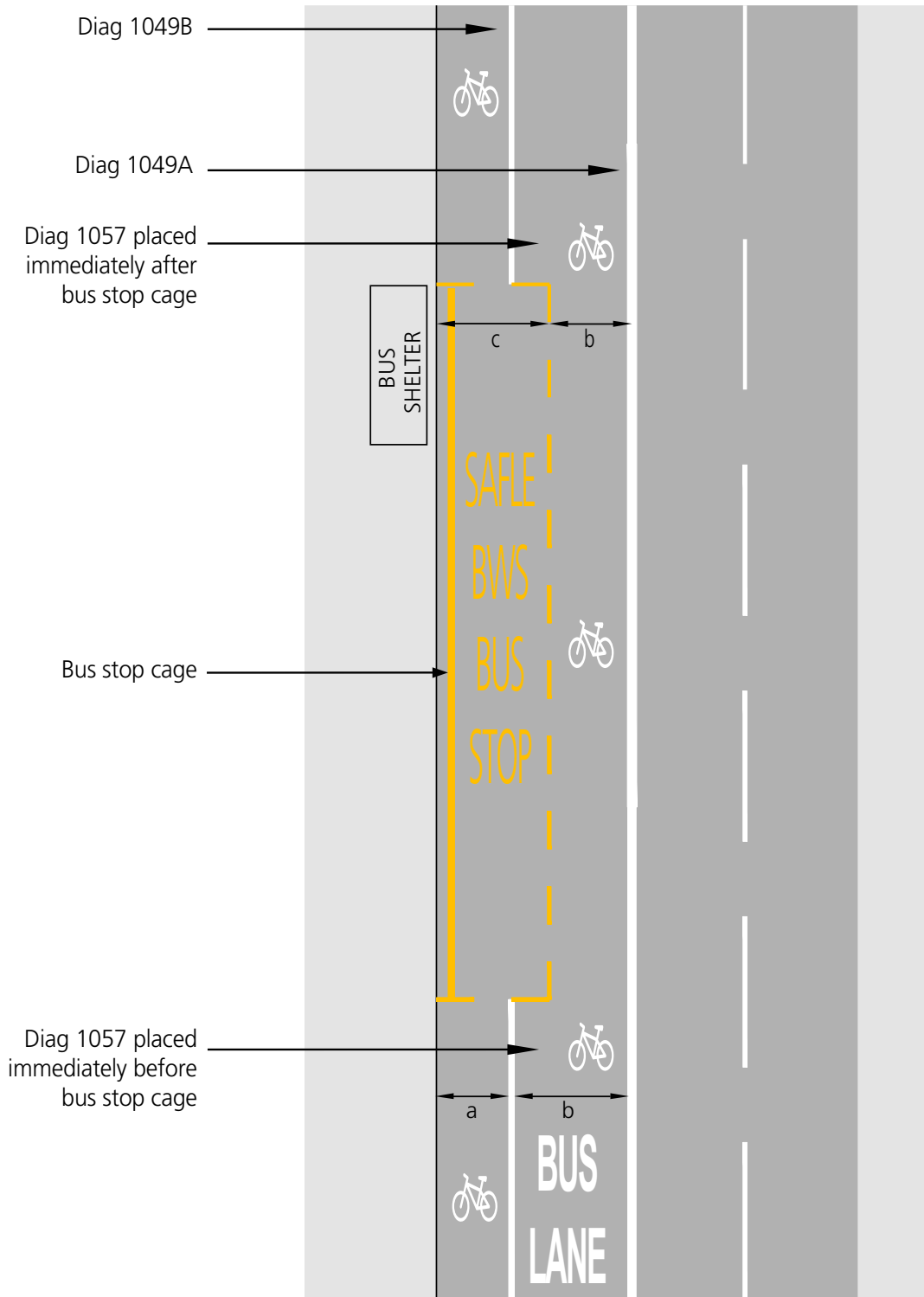

DE502 Bus stop: island bus stop

Measure and brief description

The safest and most comfortable way to enable cyclists to pass stationary buses is to provide a cycle track past the bus stop on the footway side. Passengers will board and alight from buses from the kerbed island between the cycle track and the carriageway. The suitability of this is dependent on the available space, bus frequency and passenger volume and the number of pedestrians using the footway.

Benefits

- Maintains route continuity for cyclists.
- Eliminates the risk of conflict with buses.
- More comfortable and attractive, especially for less confident cyclists.

Key design features

- Sufficient widths should be provided for pedestrians walking past the stop and on the island to accommodate passengers waiting for and alighting from buses.
- Preferred design includes a humped zebra crossing at footway level, which slows cyclists down providing more reaction time for pedestrians and increasing convenience for disabled bus users.
- Sinusoidal humps preferred on ramps.
- Minimum bypass entry/exit taper 1:10
- Tactile paving to be provided at crossing point(s) of cycle track.

Dimensions

- a – Desirable minimum 2.0m, Absolute minimum 1.5m.
- b – Island width Desirable minimum 2.0m, Absolute minimum 1.0m.

Other considerations

- This design can be used in conjunction with cycle lanes, cycle lanes with light separation, stepped cycle tracks and separated off-carriageway tracks.
- Pedestrian crossing point(s) should be provided with dropped/flush kerbs if not placed on a flat top hump.
- Bypasses should be kept clean and free from debris.
- Adequate drainage should be provided using cycle friendly gullies to prevent ponding and icing.

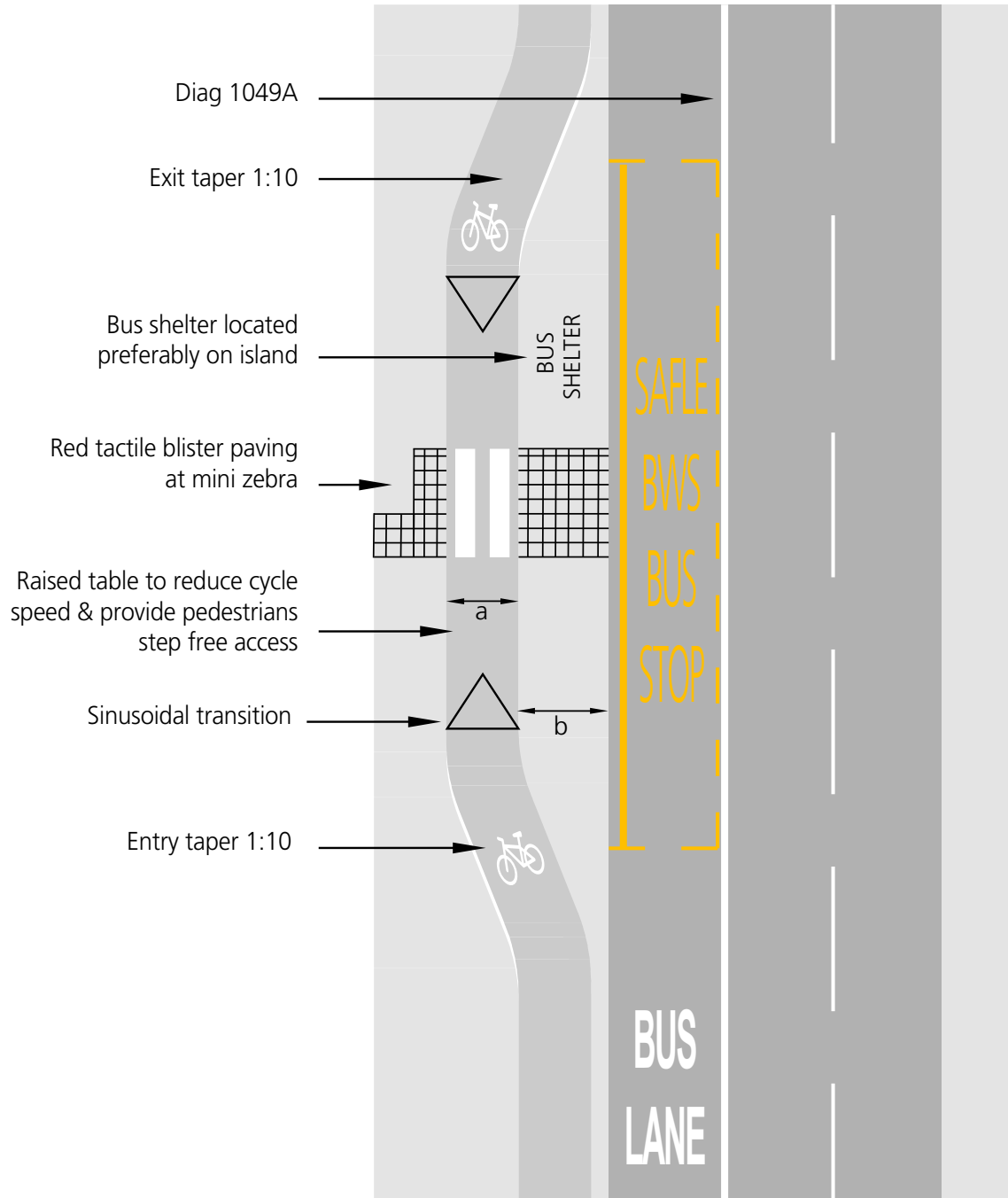

DE503 Bus stop: bus boarder

Measure and brief description

A bus boarder in line with the cycle lane/track will bring cyclists up to footway level within a shared use area enabling them to continue across the bus boarder when it is clear or to cycle past pedestrians waiting at the bus stop. Careful consideration needs to be given in how to minimise conflict between cyclists and pedestrians – this option is best suited to bus stops and footways with low passenger and pedestrian volumes.

Benefits

- Maintains route continuity.
- Eliminates the risk of conflict with buses.
- More comfortable and attractive, especially for less confident cyclists.
- Bus boarder provides step free access for bus users.

Key design features

- Ramp up to footway level to help reduce cycle speeds.
- Where the difference between levels is small a short ramp may be appropriate.
- Bus shelters and flags should be placed at the back of the bus boarder.
- Sufficient space should be provided at the back of bus stop to minimise pedestrians needing to stand in the line of cycle track.
- Good intervisibility is required between pedestrians (those waiting for a bus as well as those passing) and cyclists, to minimise potential for conflict.
- The bus stop should be apparent to cyclists, who will need to be able to adjust their behaviour and speed to reflect the additional risk of conflict.

Dimensions

- a – Bus boarder width Desirable minimum 2.0m, Absolute minimum 1.5m.
- b – Retained footway width Desirable minimum 3.0m, Absolute minimum 2.0m.

Other considerations

- Potential for conflict with pedestrians using the bus stop, use only where cycle flow is low and only a few people will ever be boarding or alighting a bus.
- This design can be considered in conjunction with cycle lanes, light separation or one-way stepped cycle tracks.

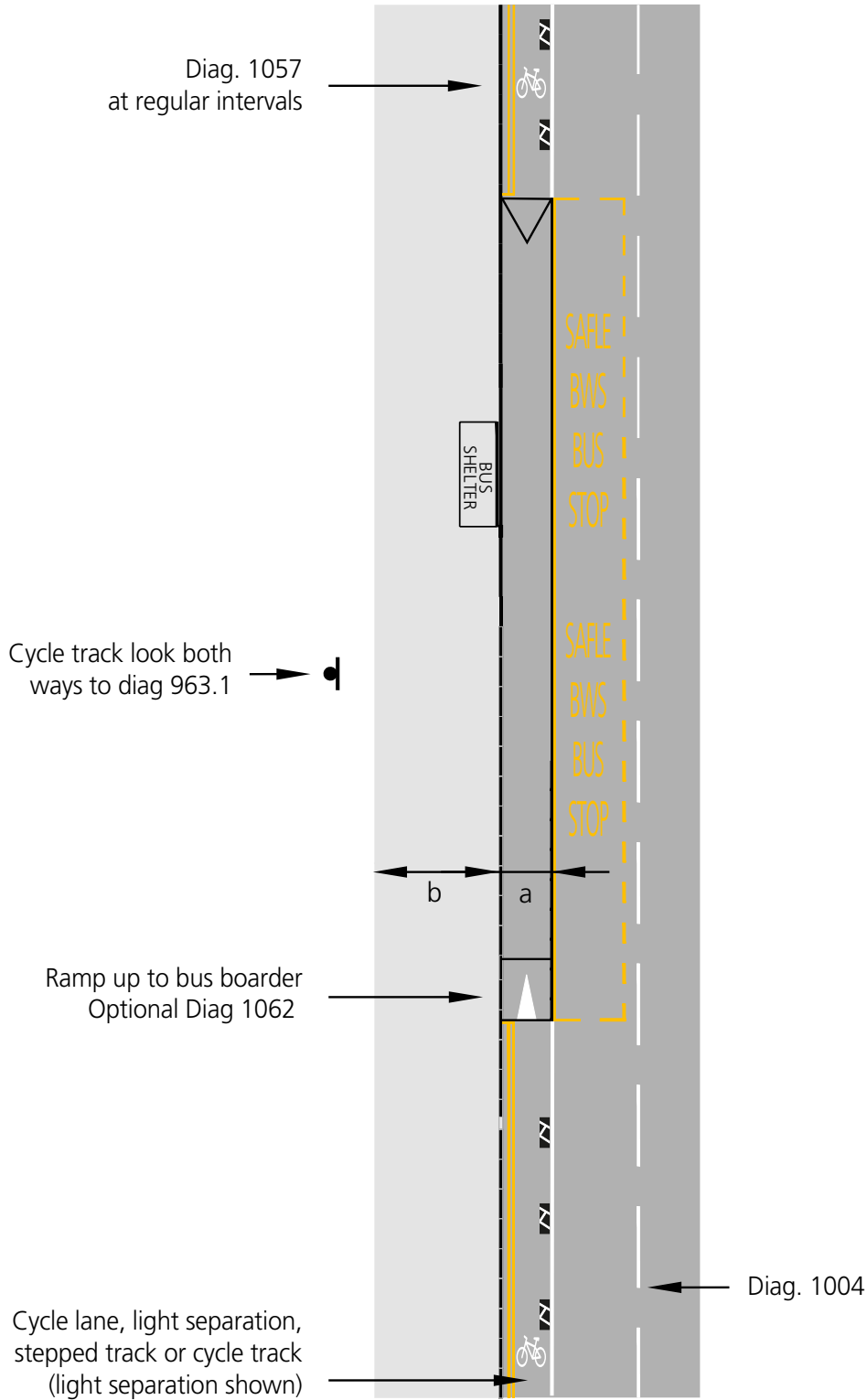

DE504 Bus stop: shared use

Measure and brief description

Bus stops can pose a difficulty on two-way cycle tracks adjacent to the carriageway, as street furniture and waiting pedestrians associated with the bus stop can cause an obstruction and it will be difficult to maintain the width required for a fully separated track. Consequently an option is to share the entire width of the path past the bus stop. This design also applies to shared use paths.

Benefits

- Maintains route continuity.
- Eliminates the risk of conflict with buses.
- Comfortable and attractive, especially for less confident cyclists.

Key design features

- Cycle track/footway separation ends each side of bus stop becoming a shared path.
- Shared area around bus stop to be kept clear of street furniture.
- Provide clear space for passengers to wait where they will not come into conflict with cyclists.
- Good intervisibility between pedestrians (those waiting for a bus as well as those passing) and cyclists, to minimise potential for conflict.
- The bus stop should be apparent to cyclists, who will need to be able to adjust their speed and yield to pedestrian traffic.

Dimensions

- a – Retained shared use path width Desirable minimum 3.0m, Absolute minimum 2.5m.
- Separation of cycle track should finish at least 15m before waiting area (in direction of general traffic) and continue 5m past.

Other considerations

- Potential for conflict with pedestrians using the bus stop or footway.
- Also used where the adjacent link is a shared use path rather than a separated footway/cycle track.
- Where possible the bus shelter should be set back outside of the line of the path to create clear sight lines and minimise potential for conflict.

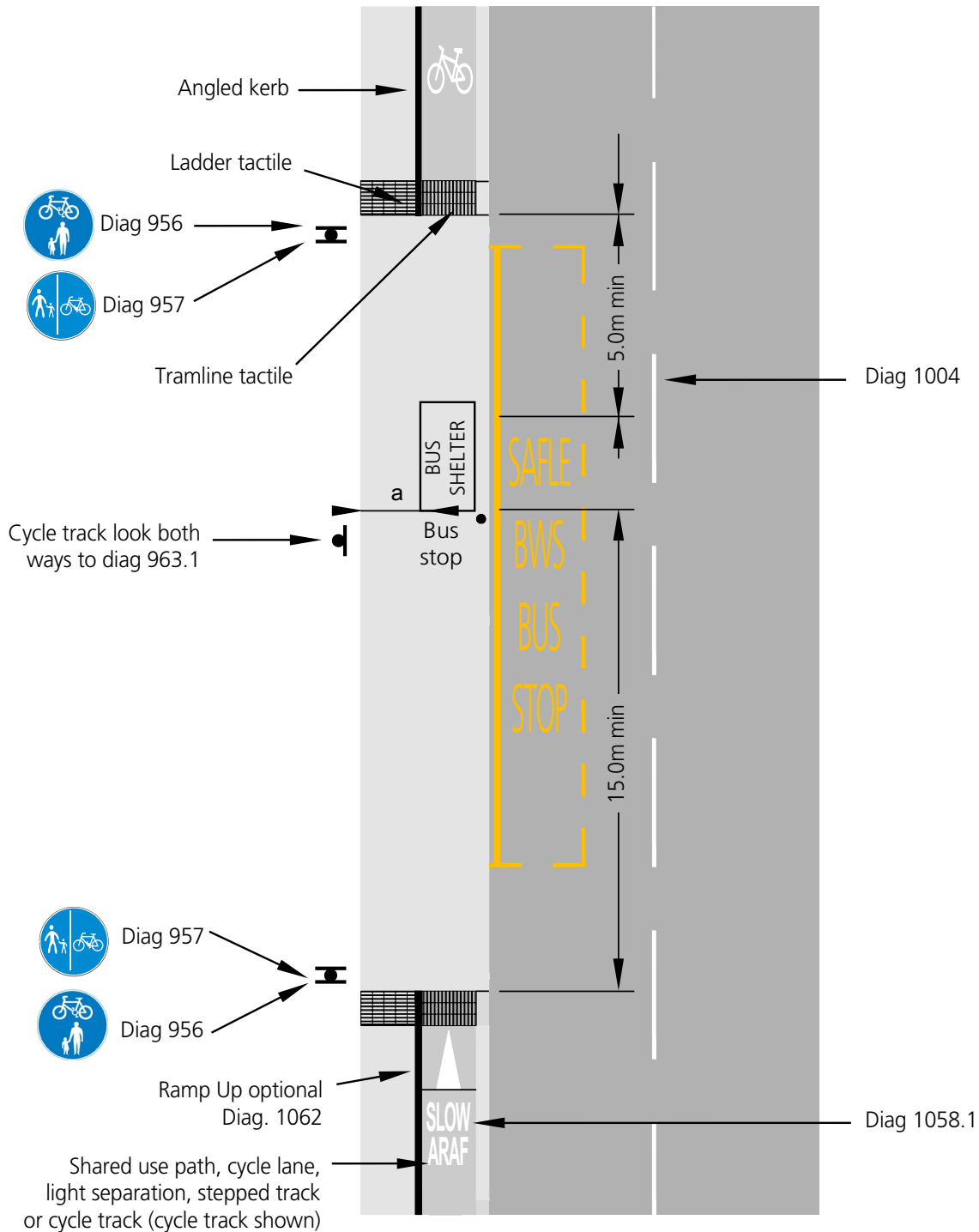

DE505 Bus lane

Measure and brief description

The primary purpose of bus lanes is to improve the reliability of bus services by giving priority to buses over other vehicles on congested parts of the road network. Combined bus and cycle lanes can also be a useful feature for cyclists, enabling cyclists to share in the congestion avoidance and time-saving benefits provided to buses, as well as providing safer conditions for cycling. The default position is to allow cyclists to use bus lanes.

Bus lanes should not be regarded as part of designated Active Travel Networks unless bus flows are light and/or there is a cycle lane within the bus lane, and no other vehicles (eg taxis, motorcycles) are allowed.

Benefits

- Gives cyclists priority over general traffic at the locations and times where it is most needed.
- Cyclists using bus lanes have less traffic to interact with than if using a general traffic lane.
- There is a space buffer between the general traffic lane and the cyclist, (albeit occupied intermittently by buses).
- Cycle lanes within bus lanes are safer and more comfortable than shared bus lanes or general cycle lanes, since cyclists are passed by fewer vehicles

Key design features

- Where bus lanes are proposed and are expected to form the main provision for cyclists along a route, a cycle lane should be provided within the bus lane.
- The cycle lane would preferably be a mandatory lane, although authorities could use an advisory lane. This will also simplify TRO requirements,
- The hours of operation of bus lanes where cyclists are permitted should normally be 'at all times' to provide the highest benefit for cyclists. Where mandatory cycle lanes operate within bus lanes, they may operate full time even if the bus lane is part time.
- Diagram 1048 ('Bus Lane') markings must always be used in with-flow situations. The use of Diagram 1048.1 ('Bus and Cycle Lane') is reserved for contra-flow facilities only unless specially authorised.

Dimensions

- a – 4.0m wide bus lane with no cycle lane is the recommended minimum width where bus speeds and volumes are low. If widths of 4.0m on lower flow routes are not possible, then the bus lane should be restricted in width to 3.2m. This removes the dilemma for bus drivers of whether there is sufficient width to overtake a cyclist within the confines of the bus lane. Cycles are still allowed to use the Bus Lane, but buses will have to drive into the general traffic lane when overtaking cyclists. Bus lane widths of between 3.2m and 3.9m should not be provided as they leave insufficient room for buses to overtake cyclists or cyclists safely and comfortably. Where off-peak car parking or loading is permitted in a bus lane, the lane should be at least 4.0m and preferably 4.5m wide in order to allow cyclists to pass stationary motor vehicles without leaving the bus lane. It is also preferable to mark parking bays within bus lanes to encourage drivers to park close to the kerb.
- b – cycle lanes within bus lanes should be: Desirable minimum 2.0m, Absolute minimum 1.5m.
- c – the minimum width for the bus lane outside of the cycle lane should be a minimum of 2.7m.

Other considerations

- Where bus lanes are provided, care should be taken to ensure that provision for cyclists in the opposite direction is not compromised.
- There is often pressure on highway authorities to permit a wide range of other users to use bus lanes, including taxis, private hire vehicles and motorcycles. This can reduce the benefits afforded to cyclists and should be avoided.

- There should be a presumption in favour of designing contraflow bus lanes to be of sufficient width to accommodate cyclists. Where this is the case the widths referred to above for with-flow bus lanes will apply.
- Where bus-only links are provided, for example between two residential neighbourhoods, the design should normally include provision for cyclists.

Further References

- Department for Transport (2018) – Traffic Signs Manual

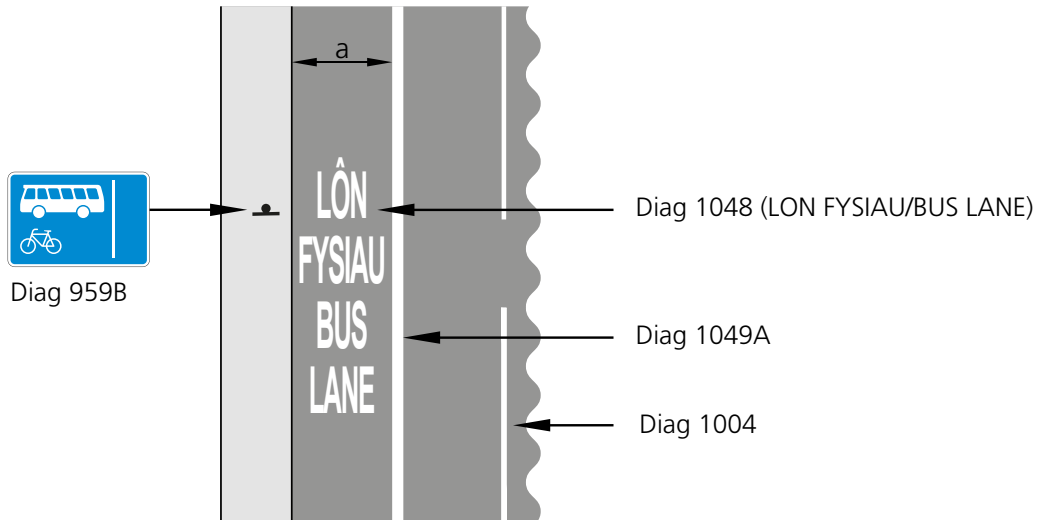

Bus lane shared with cyclists

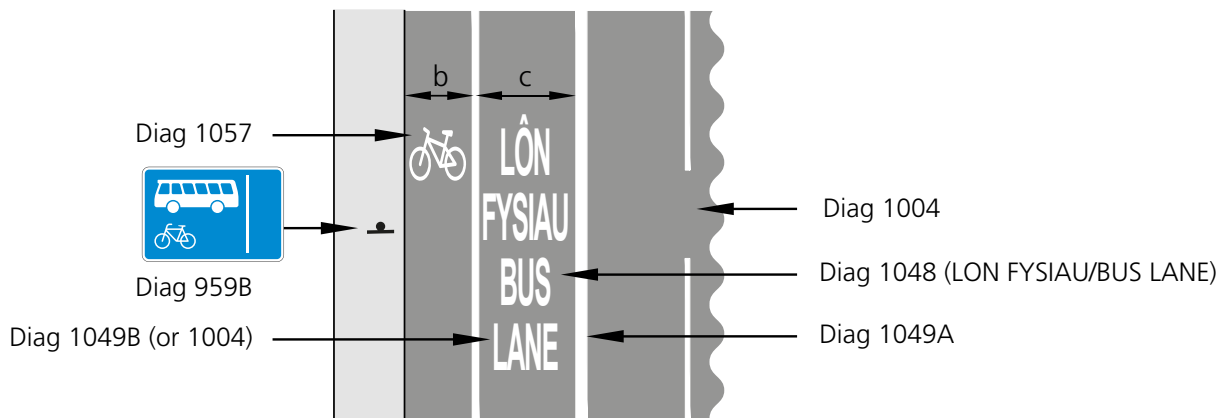

Cycle lane within bus lane (preferred)



DE601 Unmarked informal junction

Measure and brief description

Junctions in urban areas, even on relatively busy routes, can be designed without defined priority, requiring all road users to slow down and engage/negotiate with other road users. The application of these 'shared space' principles is becoming increasingly common and has been demonstrated to be effective in terms of traffic capacity and safety on four-arm junctions with peak period flows in excess of 2,500 vehicles per hour. Examples include junctions in the centre of Coventry, in Poynton in Cheshire and in Hackney (see photos). This type of junction can work well for pedestrians and cyclists.

Benefits

- Reduced delays to all users, particularly during off-peak periods.
- Improved public realm, enhancing the attractiveness of urban centres.

Key design features

- Junctions of this type should be designed to suit local circumstances – standardised solutions are not appropriate.
- Motor vehicle paths should be limited to a single lane on entries and exits.
- General lane widths should be kept as narrow as possible but separate provision may be made for cyclists so that they are able to pass queuing vehicles on the junction approaches.
- Speeds on the approaches should be around 20mph.
- Traffic signal crossings should not be used on the approaches to the junction since green signals can reinforce drivers' sense of priority over pedestrians.
- Informal (or zebra/parallel pedestrian and cycle crossings) should be provided on desire lines.
- Crossings can also be made available to cyclists so that they can travel around the junction via cycle tracks or shared paths outside the carriageway.
- Crossings should be paved in a material which contrasts with the general carriageway, with tactile paving.
- Central islands or median strips at crossings help pedestrians and cyclists to cross and make it more likely that drivers will cede priority (see DE207 and DE608).
- Paving materials that are visibly different from standard bituminous surfacing will help to reinforce the distinctiveness of the place.
- A range of kerb heights can be used between crossing points. Flush or very low kerbs will require tactile paving.

Dimensions

- Overall dimensions vary but are typically around 25m to 40m across.

Other considerations

- This type of junction works best in urban areas with high numbers of pedestrians and general activity, particularly town and city centres.
- They can form part of a wider public realm/shared space scheme, but can also be provided in isolation.
- Blind and partially sighted users and representatives should be consulted as part of any changes to the highway layout as described above.

DE601

Unmarked informal junction



Fishergate, Preston.
Uncontrolled crossing as part of wider High Street placemaking scheme.



Leonard Circus, London.
Uncontrolled junction with no designated crossings or priority.



Exchange Square, Kidderminster.
Blended crossing (with tactiles) on approach to a junction/public square with no designated priorities.



Poynton, Cheshire
Double Junction, each designed to encourage circulatory priority, with courtesy crossings, carrying circa 26,000 vehicles per day overall



Llywodraeth Cymru
Welsh Government

DE number: DE601

Do Not Scale Drawing

Copyright: Welsh Government

Previous DE number: DE049

Revision number: 2

DE602 Shared or separated pedestrian and cycle track at side road with priority

Measure and brief description

Uncontrolled shared or separated crossings at side roads should give priority to users proceeding along the major road wherever safe and practicable. Priority crossings will avoid loss of momentum and present a strong promotional message about how active travel is valued along a corridor. Factors to be considered when determining who has priority include: location, motor vehicle speed and volume, visibility, number of pedestrian and cycle movements and collision records.

Benefits

- Improved continuity and reduced effort for cyclists.
- Raised status for pedestrian and cyclists.
- Reduced vehicle speeds on side roads entering junction.

Key design features

- Side roads and accesses where vehicle speeds are less than 30mph and volume is less than 2,000 vehicles per day will normally be suitable for cycle priority crossings.
- When cycle tracks are two way, drivers waiting to turn right into a side road may not anticipate cycles approaching from behind. Similarly drivers emerging from the side road may not anticipate cycles approaching from the left. One way cycle tracks which operate in the same direction as general traffic are therefore preferred.
- Priority crossings should be located on a raised table.
- The corner radii and carriageway width of the side road should be minimised.
- Cycle track should not turn through more than 45 degrees on approaches.
- There needs to be good levels of inter-visibility between pedestrians, cyclists and motorists.

Dimensions

- Priority crossings are often 'bent out', i.e. set back 5m from the junction channel line to enable a car to stop clear of the main carriageway. However, there are now a number of schemes where the crossing has been built closer to the junction which have operated satisfactorily (see section 12.5).
- This option can be considered where there is only light traffic using the side road and speeds on the main road are no greater than 30mph.

Other considerations

- Consider highlighting the crossing with coloured surfacing.
- Cycle track crossings can be difficult places for younger or inexperienced cyclists to negotiate, as they need to ensure that they are aware of vehicles on both the main carriageway and the side roads and judge speeds and turning movements. Simple design and clear signing is therefore important.
- Corduroy hazard paving can be used in addition to the blister paving where there is a lack of a kerb upstand early engagement with groups representing people with sight loss and other disabilities is essential, particularly where new or uncontrolled crossings are proposed.

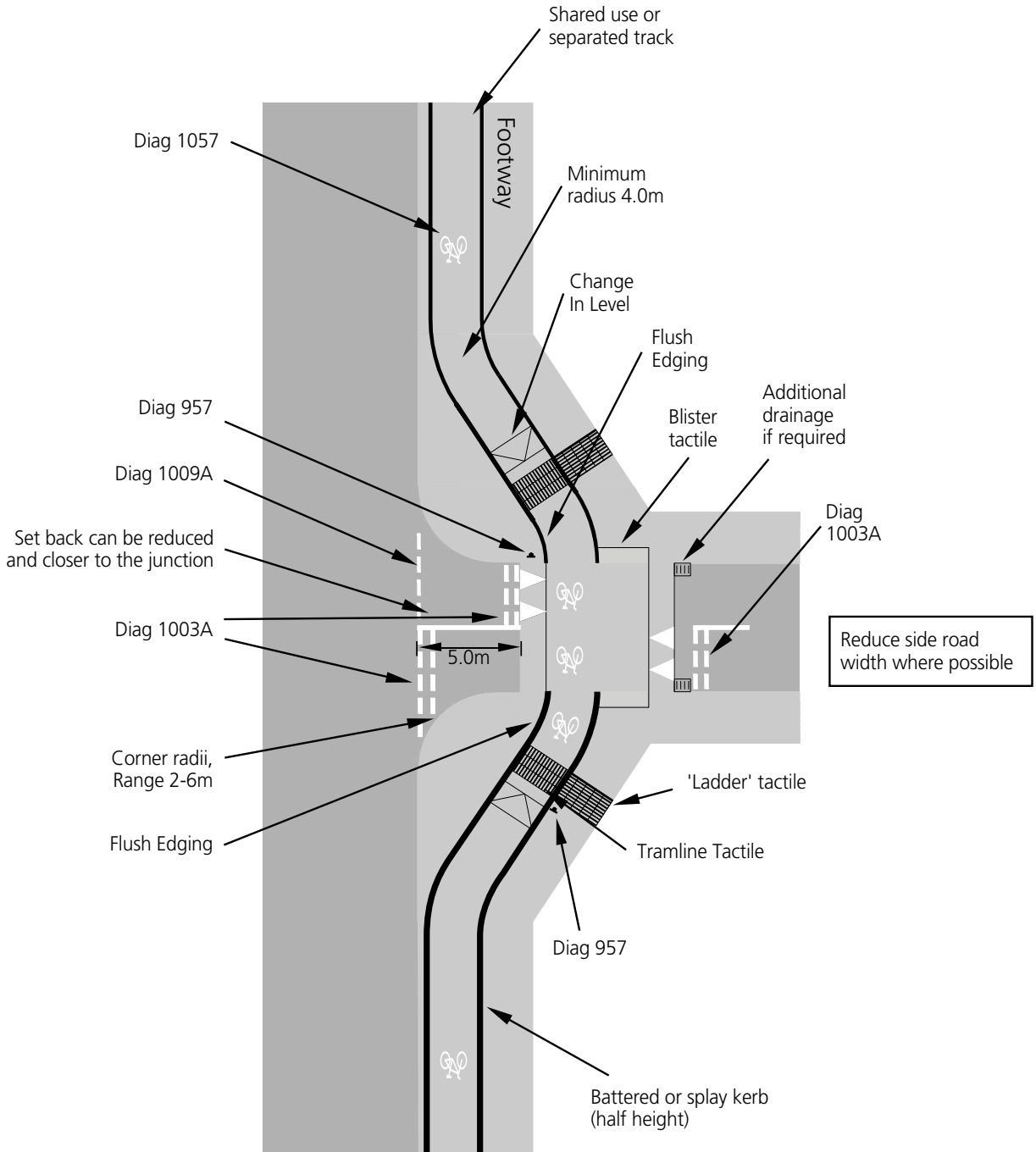

DE603 Shared or separated pedestrian and cycle track at side road give way

Measure and brief description

Priority crossings (DE602) will not be appropriate in all locations, and where the user is expected to give way at a side road, clear road markings will be necessary, together with measures to reduce the speed of vehicles using the junction. Factors to be considered when determining who has priority include: location, motor vehicle speed and volume, visibility, number of pedestrian and cycle movements and collision records.

Benefits

- Less land required than 'bent out' priority crossings (DE602).
- Retains line of cycle track.

Key design features

- Side roads and accesses where vehicle speeds are less than 30mph and volume is less than 2,000 vehicles per day will normally be suitable for priority crossings.
- When cycle tracks are two way, drivers waiting to turn right into a side road may not anticipate cycles approaching from behind. Similarly drivers emerging from the side road may not anticipate cycles approaching from the left. One way cycle tracks which operate in the same direction as general traffic are therefore preferred.
- The corner radii and carriageway width of the side road should be minimised.
- Cycle track should not turn through more than 45 degrees on approaches.
- There needs to be good inter-visibility between pedestrian, cycle and motor traffic.

Dimensions

- Side road crossings where users give way do not need to be set back from the main road carriageway any further than the main track itself.

Other considerations

- Cyclists have to look through a wide angle to see approaching vehicles.
- Consider highlighting the crossing with coloured surfacing.
- Cycle track crossings can be difficult places for younger or inexperienced cyclists to negotiate, as they need to ensure that they are aware of vehicles on both the main carriageway and the side roads and judge speeds and turning movements. Simple design and clear signing is therefore important.
- Corduroy hazard paving can be used in addition to the blister paving where there is a lack of a kerb upstand early engagement with groups representing people with sight loss and other disabilities is essential, particularly where new or uncontrolled crossings are proposed.

DE603

Shared or separated pedestrian and cycle track at side road give way

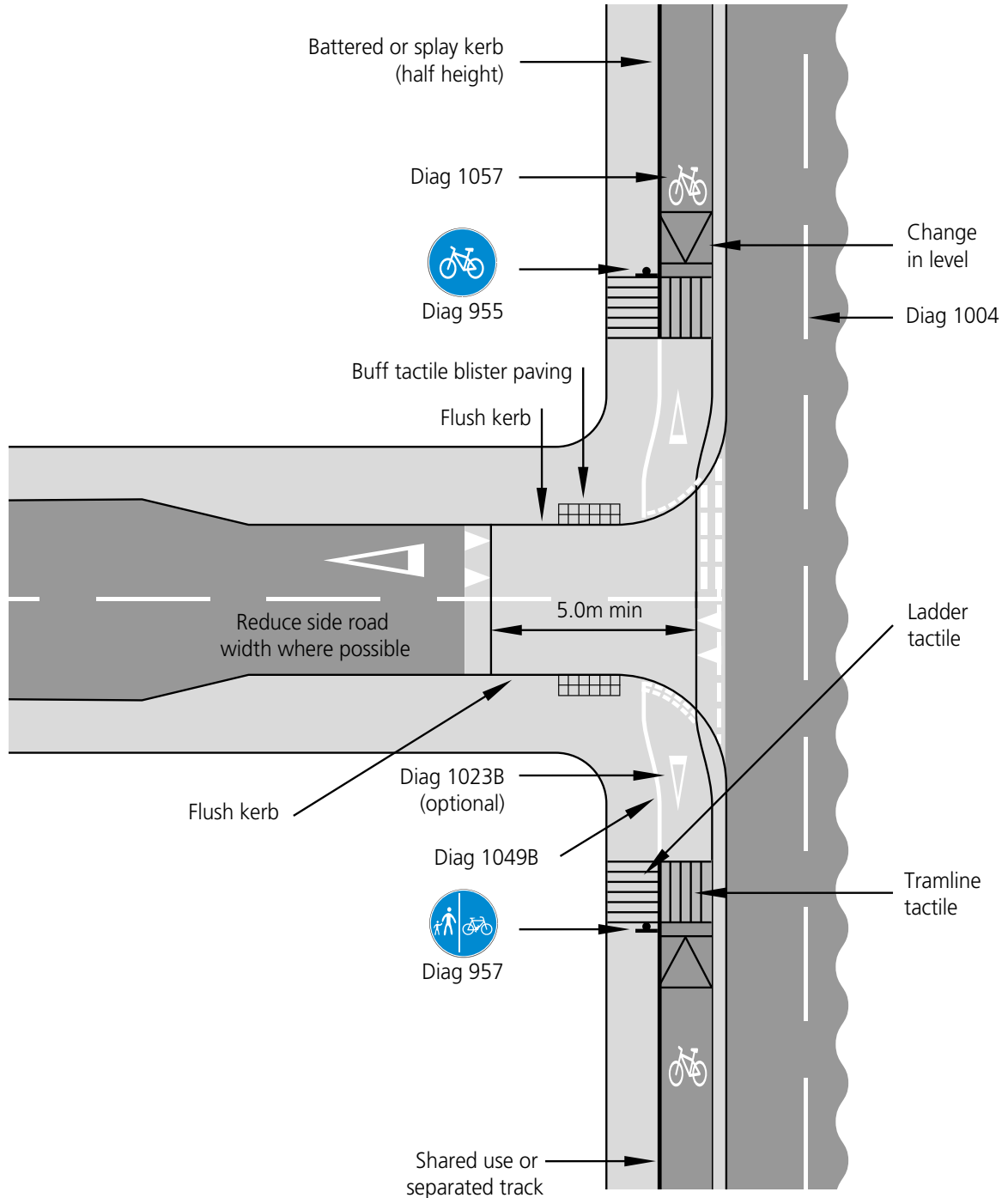

Llywodraeth Cymru
Welsh Government

DE number: DE603

Previous DE number: DE026

Do Not Scale Drawing

Revision number: 3

Copyright: Welsh Government

DE604 Side road entry treatment

Measure and brief description

Pedestrian crossings will be usually be provided across minor roads at side road junctions, if only in the form of dropped kerbs. Side road entry treatments involve raising and narrowing the mouth of the junction to make it easier and safer for pedestrians to cross the minor arm by reducing the speeds of turning vehicles, shortening the length of the crossing and providing a level route. The side road entry treatment also encourages drivers to give way to pedestrians who have started to cross.

Benefits

- Side road entry treatments make it easier and more convenient for pedestrians to cross the side road.
- They also provide safety benefits to cyclists, helping to prevent collisions with motor vehicles turning into and out of the side road.

Key design features

- Raising the carriageway to footway level across the mouth of the side road.
- Narrowing the side road to shorten the crossing distance and reduce traffic speeds.
- Tightening the corner radii of side road junctions which will slow down turning vehicles and enable the crossing point to be closer to the desire line.
- The top of the raised table should be constructed in material which contrasts with the carriageway to indicate to drivers that they should treat it differently. It may be paved in a similar material to the footway on either side.
- Tactile paving to be provided at the pedestrian crossing points.

Dimensions

- a – Corner radii – Desirable maximum 3.0m, Absolute maximum 6.0m.

Other considerations

- Raised tables are a form of traffic calming and as such cannot be used on roads with a speed limit greater than 40 mph.
- The gradient of the ramp should be considered so as not to create a hazard for motorcycles and cyclists turning into the side road.
- Corner radii will depend the swept path requirements of vehicles turning into or out of the side road (allowing for vehicles to cross centrelines unless flows are high).
- Tight corner radii will enable pedestrian crossing points to be provided on the desire line.
- Bollards may be provided to prevent over-run on corners.
- Strengthened corners may be necessary if over-run is to be expected.
- Care should be taken to ensure adequate drainage provision to prevent ponding of water at the bottom of the ramps with a raised table, or in the corners of build outs.
- Corduroy hazard paving can be used in addition to the blister paving where there is a lack of a kerb upstand early engagement with groups representing people with sight loss and other disabilities is essential, particularly where new or uncontrolled crossings are proposed.

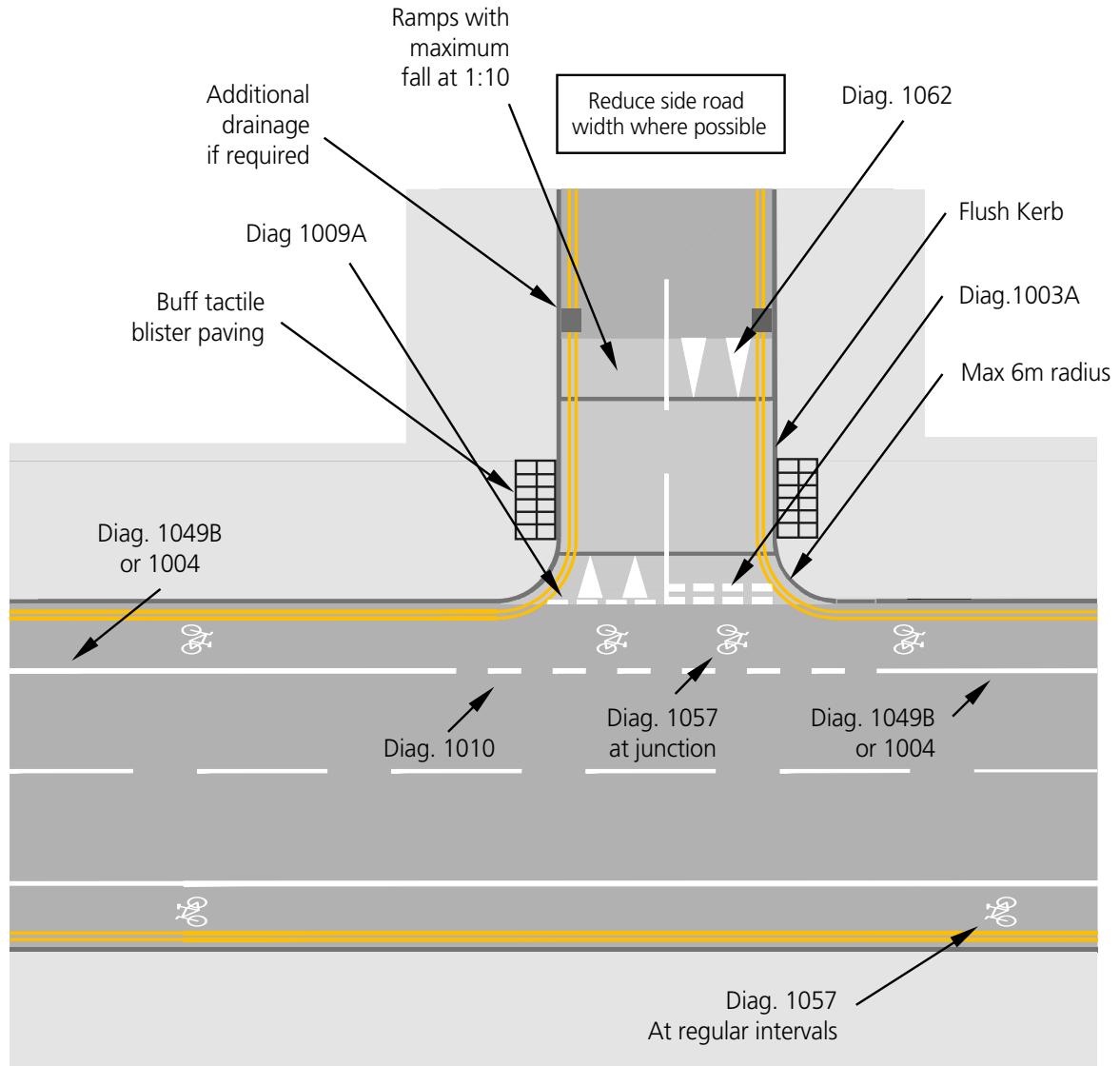

DE605 Blended side road entry treatment

Measure and brief description

Pedestrian crossings will be usually be provided at side road junctions, if only in the form of dropped kerbs. Blended side road entry treatments involve continuing the footway across the mouth of the junction without any change to make it easier and safer for pedestrians to cross by reducing the speeds of turning vehicles, shortening the length of the crossing and providing a level route. The continuous footway strongly indicates to drivers that they should to give way to pedestrians using the footway.

Benefits

- Blended side road entry treatments make it easier and more convenient for pedestrians to cross the side road.
- They also provide safety benefits to cyclists, helping to prevent collisions with motor vehicles turning into and out of the side road.

Key design features

- Raising the carriageway to footway level across the mouth of the side road.
- Narrowing the side road to shorten the crossing distance and reduce traffic speeds.
- Tightening the corner radii of side road junctions which will slow down turning vehicles and enable the crossing point to be closer to the desire line.
- The top of the raised table should be constructed in material which contrasts with the carriageway to indicate to drivers that they should treat it differently. It may be paved in a similar material to the footway on either side.
- Tactile paving is not provided as it suggests that pedestrians should give way to turning vehicles. The design relies on the fact that vehicles are crossing over a continuous footway.

Dimensions

- a – Corner radii – Desirable maximum 3.0m, Absolute maximum 6.0m.

Other considerations

- The absence of tactile paving and any height difference means that it is almost impossible for blind and partially sighted users to identify the side road crossing. Blind and partially sighted users and representatives should be consulted as part of any changes to the highway layout as described above.
- Raised tables are a form of traffic calming and as such cannot be used on roads with a speed limit greater than 40 mph.
- The gradient of the ramp should be considered so as not to create a hazard for motorcycles and cyclists turning into the side road.
- Corner radii will depend the swept path requirements of vehicles turning into or out of the side road (allowing for vehicles to cross centre lines unless flows are high).
- Tight corner radii will enable pedestrian crossing points to be provided on the desire line.
- Bollards may be provided to prevent over-run on corners.
- Strengthened corners may be necessary if over-run is to be expected.
- Care should be taken to ensure adequate drainage provision to prevent ponding of water at the bottom of the ramps with a raised table, or in the corners of build outs.

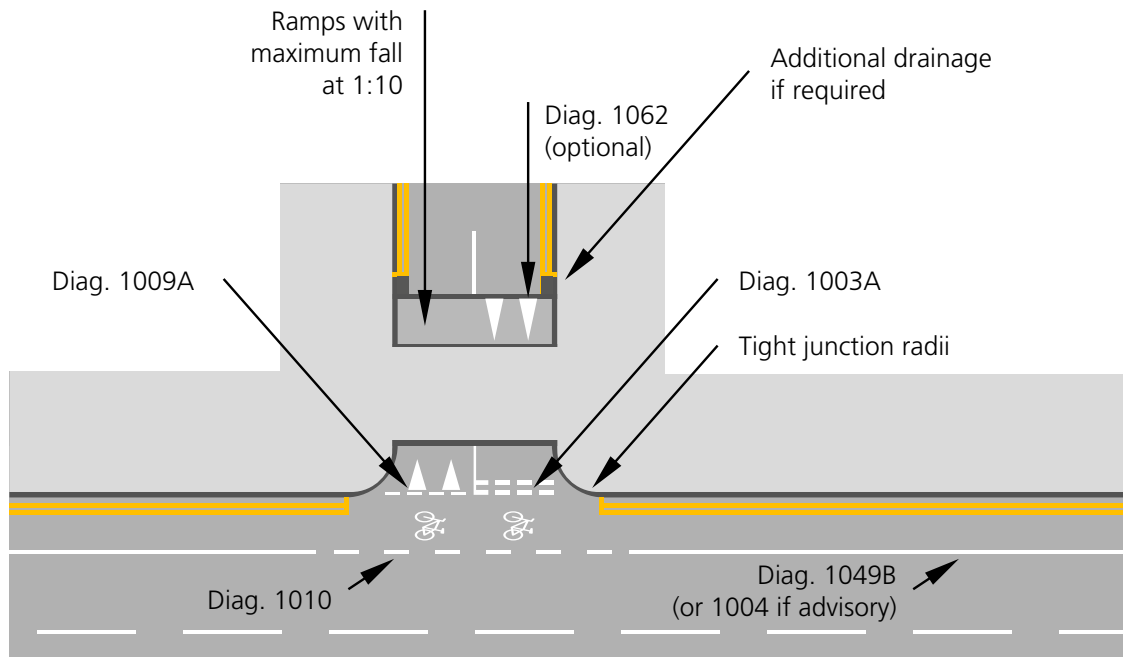

Layout 1

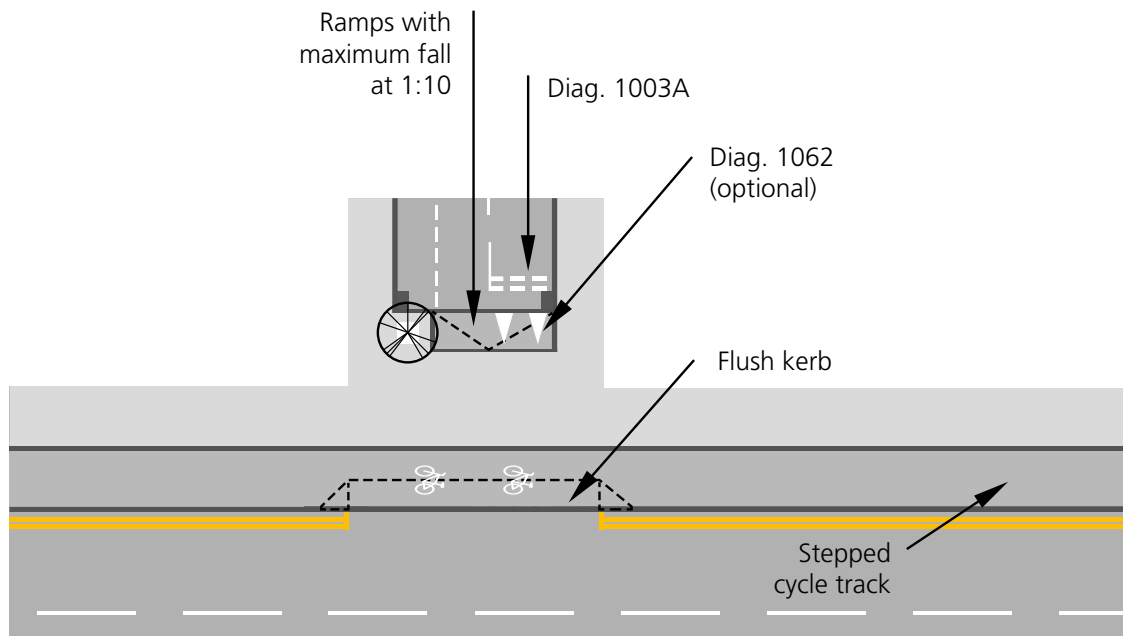

Layout 2



DE606 Simple uncontrolled crossings (walking, shared use or cycle only)

Measure and brief description

This is the simplest form of pedestrian or cycle crossing where a footway, footpath, shared use path or cycle track meets the road at a dropped kerb.

Benefits

- Alerts drivers to the presence of crossing pedestrians and cyclists.
- Indicates to pedestrians a suitable crossing place.
- Relatively cheap to install.

Key design features

- Tactile paving to be provided at dropped kerbs.
- A coloured surface may be useful to highlight the presence of the crossing to motor traffic.
- If the road has a speed limit of 30 mph or less, the crossing may be placed on a flat topped road hump. If so, it needs to be made clear to cyclists that they must give way when crossing.
- Road humps must comply with the Highways Act 1980, Sections 90A to 90F.
- Where it is not clear to cyclists approaching the crossing that they are about to meet a road, it may be worthwhile adding markings (and possibly signs) indicating that they should give way.
- On single carriageway roads with two lanes where the national speed limit of 60mph applies or on other rural roads where a lower speed limit is in place, consideration should be given to additional measures such as light coloured antiskid surfacing for 50m either side of the crossing, rumble strips on the approaches, localised visual narrowing in vicinity of crossing and Diagram 950 warning signs on the approaches.

Dimensions

- Width of crossing (a) to be at least as wide as the path either side. On pedestrian only routes this should be 2m min, on shared use paths, 3m min.

Other considerations

- Any coloured surface needs to maintain a good condition to remain effective.
- The effect of parked vehicles in the vicinity of an uncontrolled crossing should be considered and if necessary parking restrictions imposed to maintain adequate visibility.
- Vehicle crossovers are not suitable as pedestrian crossing points and care should be taken over the siting of crossings relative to crossovers so as not to cause confusion to users.
- Build outs can reduce the crossing distance, and in some situations will aid visibility, but can impede on-road cyclists. Designers should understand the impact that creating a better crossing point can have on a cyclist already on the road.
- Physical changes to the kerb lines can be costly but reducing the carriageway width is an effective solution.
- In rural locations detectors on the approach paths can be used to trigger vehicle activated signs to alert motor traffic of the presence of an infrequently used crossing only when there are cyclists or pedestrians present.

DE606

Simple uncontrolled crossings (walking, shared use or cycle only)

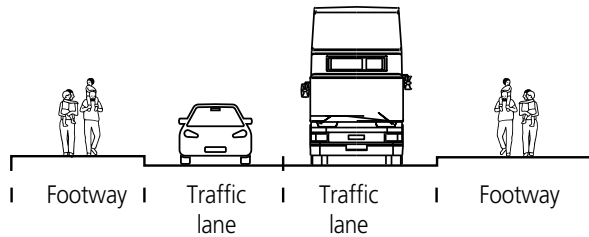

Buff tactile
blister paving

Flush kerb

Consider
contrasting or
coloured surface

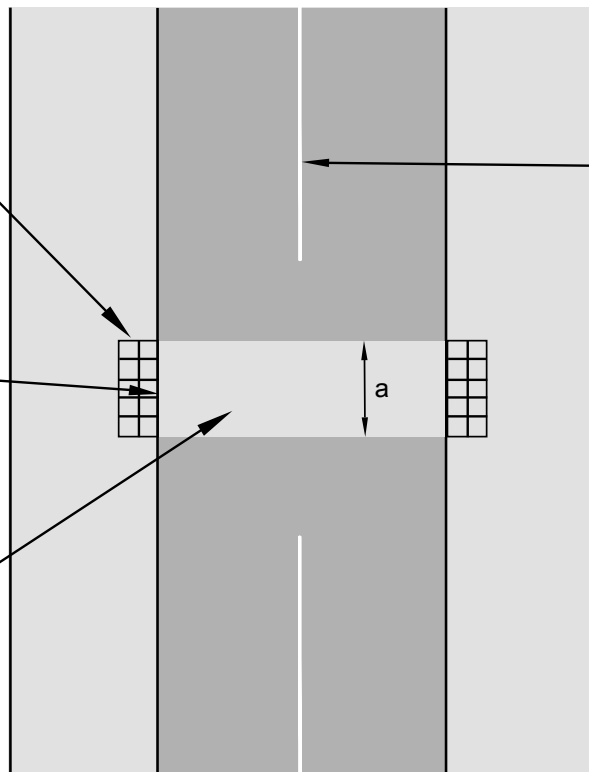

Diag. 1004



Llywodraeth Cymru
Welsh Government

DE number: DE606

Previous DE number: DE036

Do Not Scale Drawing

Revision number: 2

Copyright: Welsh Government

DE607 Cycle priority crossing

Measure and brief description

Where a cycle track crosses a carriageway, the cycle track can be given priority over vehicles travelling along it. Care needs to be taken to ensure it is clear to motorists that they must give way, and that there is sufficient visibility along the cycle track. This type of crossing is best suited to relatively lightly trafficked slower speed roads.

Benefits

- Continuity of cycle route.
- Minimises delay and effort for cyclists.
- Affords visible priority to cyclists.

Key design features

- Priority cycle crossings are generally suitable where main road flows are up to 4,000 vehicles per day, and speeds are up to 30mph (see Table 12.1).
- A road hump is not a legal requirement, but is desirable to reduce traffic speeds locally.
- Road humps must comply with the Highways (Road Humps) Regulations 1999.
- Tactile paving to be provided to alert blind and partially sighted users.
- A coloured surface may be useful to highlight the presence of the crossing to motor traffic.
- Care should be taken to provide sufficient visibility. The crossing itself and its immediate approaches should be visible to approaching motorists at their stopping sight distance. The crossing should be lit.
- Although not mandatory, give way signs to diagram 602 will usually be required at the cycle track crossing and 1003 road markings may not be sufficiently obvious to approaching drivers on their own. The give way sign should be supplemented with a variant of diagram 962.1, varied to read 'Cycle track', with Welsh Government authorisation.

Dimensions

- Width of crossing to be at least as wide as the cycle track either side, 3.0m min.

Other considerations

- Where cycle approach speeds are high or visibility restricted it is preferable to use path approach geometry or humps to slow cyclists. Barriers should not be used.
- Cycle priority crossings may also have central refuges (DE608).
- If pedestrians are also crossing a Parallel Crossing should be provided (DE611).

Further References

- Department for Transport (2018) – Traffic Signs Manual

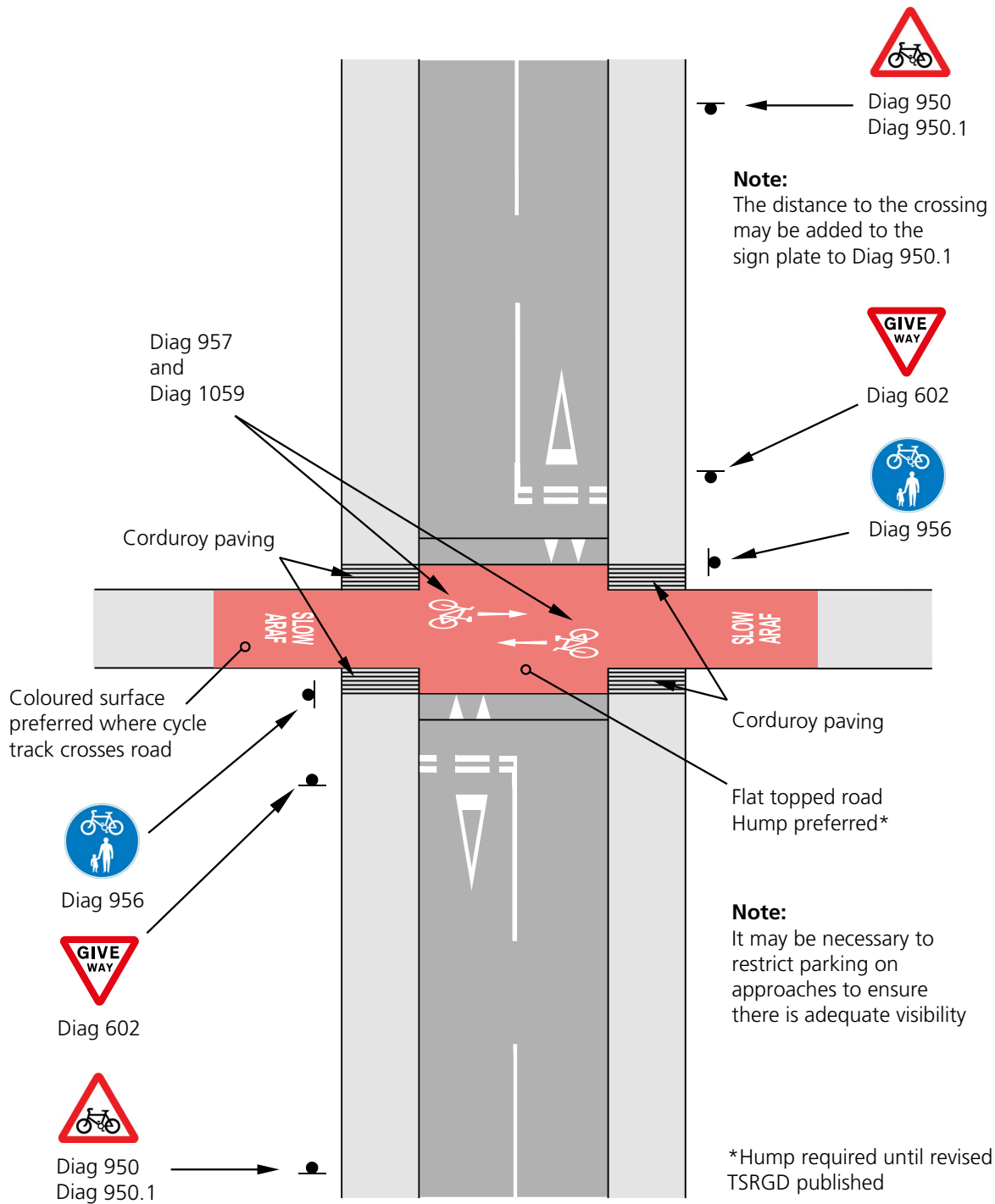

DE608 Uncontrolled crossing with central refuge

Measure and brief description

Where the crossing of a road cannot easily be carried out in one stage due to the speed and volume of traffic or the width of the carriageway it will be necessary to provide a refuge for pedestrians and possibly cyclists to wait safely and make the crossing in two sections.

Benefits

- A high quality refuge crossing can considerably reduce the time needed to cross a busy road.
- Drivers are more likely to informally cede priority to pedestrians and/or cyclists where there is a refuge, as they know that they are inviting people to cross to a safe place.

Key design features

- Central refuges should be at least as wide as the approach paths.
- Crossings should be in a straight line.
- Refuges should normally be kerbed in order to provide a degree of protection and subjective safety to users.
- Flush kerbs and tactile paving should be provided in line with the dropped kerbs at the edge of the road, in the refuge and on the footways on either side.
- The refuge will often (but not always) need to be marked with bollards facing approaching traffic. These bollards may need to be illuminated in some circumstances - see Traffic Advisory Leaflet 3/13 and TSRGD.
- On single carriageway roads with two lanes where the national speed limit of 60mph applies or on other rural roads where a lower speed limit is in place, consideration should be given to additional measures such as light coloured antiskid surfacing for 50m either side of the crossing, rumble strips on the approaches, and beacons and Diag 950 warning signs on the approaches.

Dimensions

- a – Width of crossing to be at least as wide as the path either side. On pedestrian only routes this should be 2m min, on cycle tracks or shared use paths 3m min.
- b – Depth of pedestrian refuge should be a minimum of 2m to accommodate a wheelchair and pusher, or 4m where pedestrian flow > 600/hour; absolute minimum 1.2m.
- b – Depth of refuge for use by cyclists should be a minimum of 2m, or 2.4m on roads subject to national speed limit. A depth of 3m will accommodate a cycle towing a trailer, or a tandem.
- c – Refuges should not be designed to retain a running lane width of between 3.2m — 3.9m. This will encourage motorists to think that they can squeeze through ahead of cyclists.

Other considerations

- The size of refuge should cater for peak flows in excess of current usage and allow for groups of pedestrians or cyclists (especially families) to wait together.
- The effect of parked vehicles in the vicinity of a refuge should be considered and if necessary parking restrictions imposed to maintain adequate visibility.
- Clutter-free (eg guard railing) median islands will act as refuges for pedestrian and cyclist crossing movements and improve visibility and the street scene.
- In rural locations detectors on the approach paths can be used to trigger vehicle activated signs to alert motor traffic of the presence of an infrequently used crossing only when there are cyclists or pedestrians present.

Further References

- Department for Transport (2013) - Traffic Advisory Leaflet 3/13. Traffic Bollards and Low Level Traffic Signs.

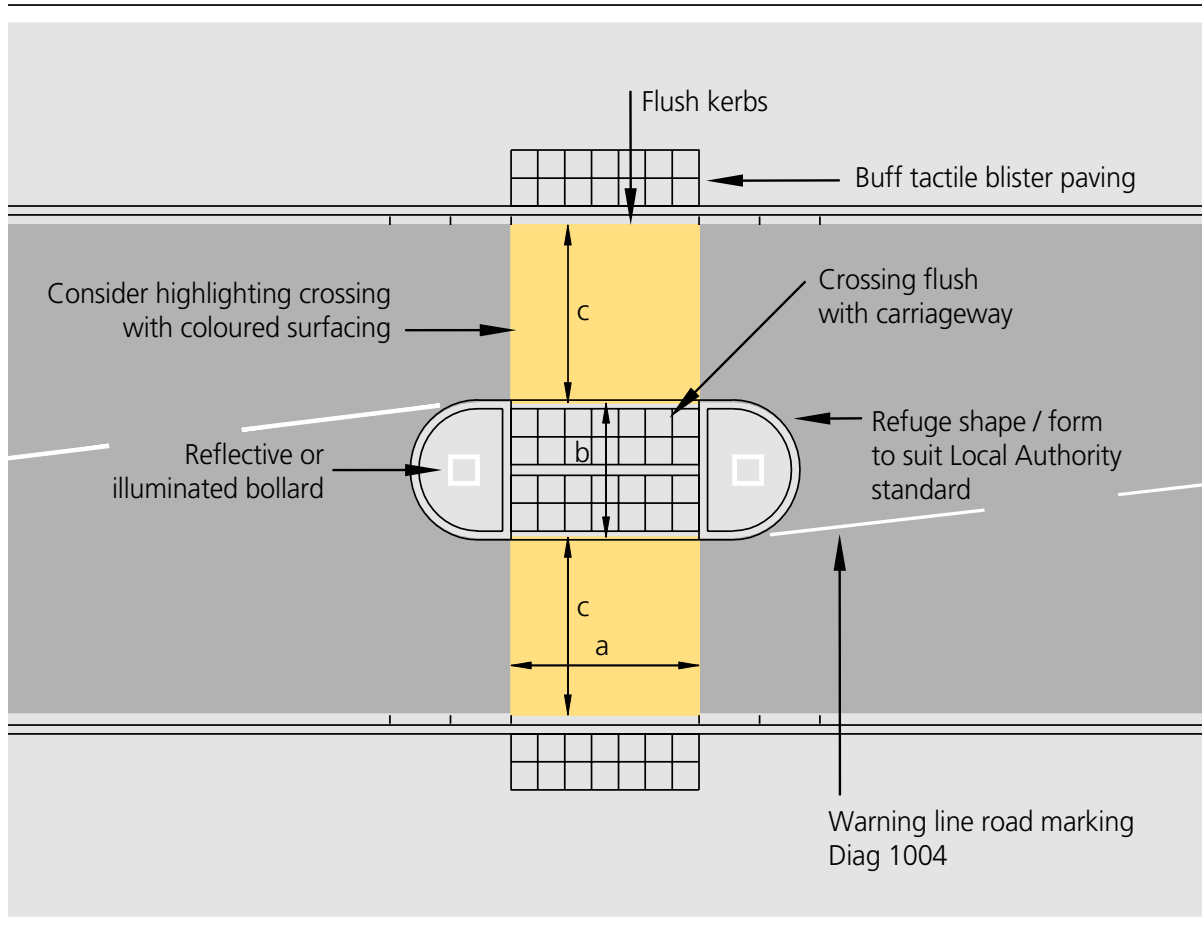

DE609 Cycle track on opposite side to junction

Measure and brief description

This drawing shows a simple arrangement where a two way cycle track is on the opposite side of the road to a priority junction. In this arrangement the cycle track access essentially forms a fourth arm at the junction to create a cross roads arrangement.

Benefits

- Cycle and pedestrian traffic is able to easily travel between the separate cycle track and the carriageway of the minor road. Cycle traffic takes a logical and predictable route through the junction which is likely to be easily understood by all road users.

Key design features

- Tactile paving should be used to guide pedestrians if they need to cross the cycle track (i.e. if the footway along the main road is next to the carriageway with the cycle track behind it).
- Use of half-size Give Way markings on the cycle track.
- The cycle track should be flush with carriageway at the point of intersection.

Dimensions

- Cycle track width should be sufficient to accommodate the forecast level of cycle use with a minimum of:
 - » Absolute minimum 2.5m
 - » Desirable minimum 3.0m

Other considerations

- This arrangement is suitable for quieter low-speed roads (30mph or less) in urban areas. Where traffic speeds or flows are high, a controlled junction or crossing should be considered.

DE609

Cycle track on opposite side to junction

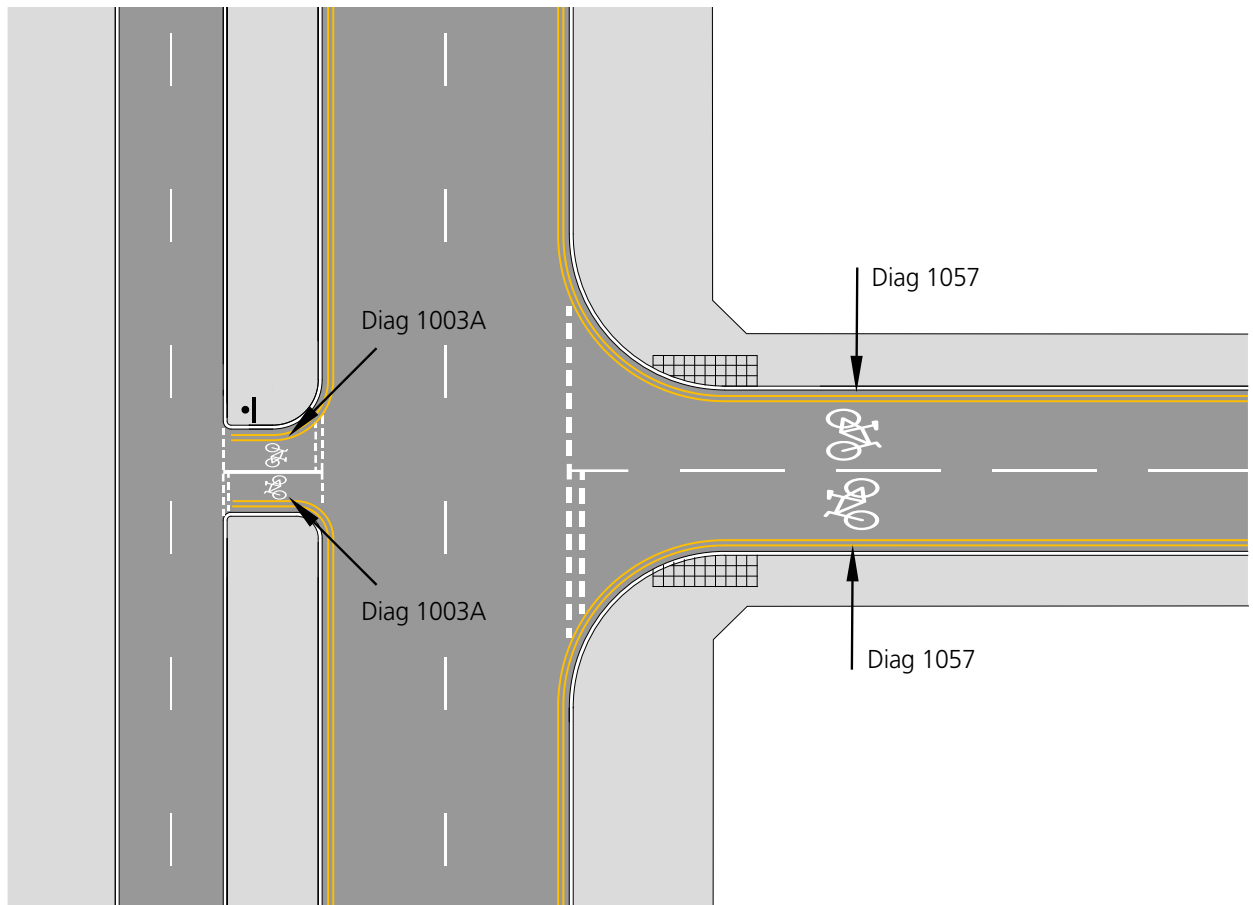

Llywodraeth Cymru
Welsh Government

DE number: DE609

Previous DE number: N/A

Do Not Scale Drawing

Revision number: 1

Copyright: Welsh Government

DE610 Zebra crossing

Measure and brief description

A Zebra crossing is marked on the carriageway with transverse black and white stripes and yellow flashing globes (belisha beacons) on black and white striped poles at each side of the crossing. A driver must stop at a zebra crossing when a pedestrian starts to cross; Zebra crossings are not designed to accommodate cyclists. Parallel crossings for pedestrians and cyclists are shown on DE611 and cycle-only priority crossings on DE607.

Benefits

- Zebra crossings provide relatively low-cost pedestrian priority crossing facilities which give an immediate response to pedestrians' need to cross.
- They can be placed closer to junctions than signalised crossings, reducing the need to deviate from desire lines.
- Unless pedestrian flows are very high they result in lower delays to vehicles. Central median strips enable pedestrians to cross carriageways in two stages away from formal crossing points.

Key design features

- There should be adequate visibility to a zebra crossing to ensure that approaching motorists can see a pedestrian about to cross the road.
- Zebra crossings may be sited on a flat-topped road hump (raised table) to slow traffic and highlight the presence of the crossing.
- Zebra crossings may either cross a full width carriageway in a single stage or comprise two crossings with a central refuge.
- Zebra crossings can be used across minor junctions close to the give way line.
- Zebra crossings should be at least five metres from a side road junction, measured from the driver's position in the adjacent road.
- When provided on the approach or exit from a roundabout Zebra crossings should be located between 5m and 20m from the give way line.
- 8 zig zag markings are normally provided on either side of the crossing, which prevent parking, loading or overtaking. The maximum number is 18 and the minimum number is 2.
- Tactile paving to be provided.

Dimensions

- a – Crossing width 4m minimum, 10m maximum.
- b – Distance of give way line to crossing 1.1m minimum, 3.0m maximum.
- Zig zag markings can be placed up to 2.0m from the kerbline so that space for cycling can be maintained up to the crossing.

Other considerations

- A blind person would not start to cross until sure that vehicles have stopped and would therefore seek a pedestrian controlled signal crossing. Other groups of pedestrians, including people with learning disabilities and older people may feel safer and more comfortable using signalised crossings.
- Zebra crossings are unsuitable in locations where the 85th percentile vehicle speed is greater than 35mph or where there would be regular congestion resulting from high vehicle or pedestrian flows.
- Where a zebra crossing is used on a road of two lanes or more consideration should be given to whether a vehicle stopped in the nearside lane will obstruct visibility to a crossing pedestrian from a vehicle in the off-side lane.
- Crossings may be divided by a refuge – see DE608.

Further References

- Department for Transport (2018) – Traffic Signs Manual

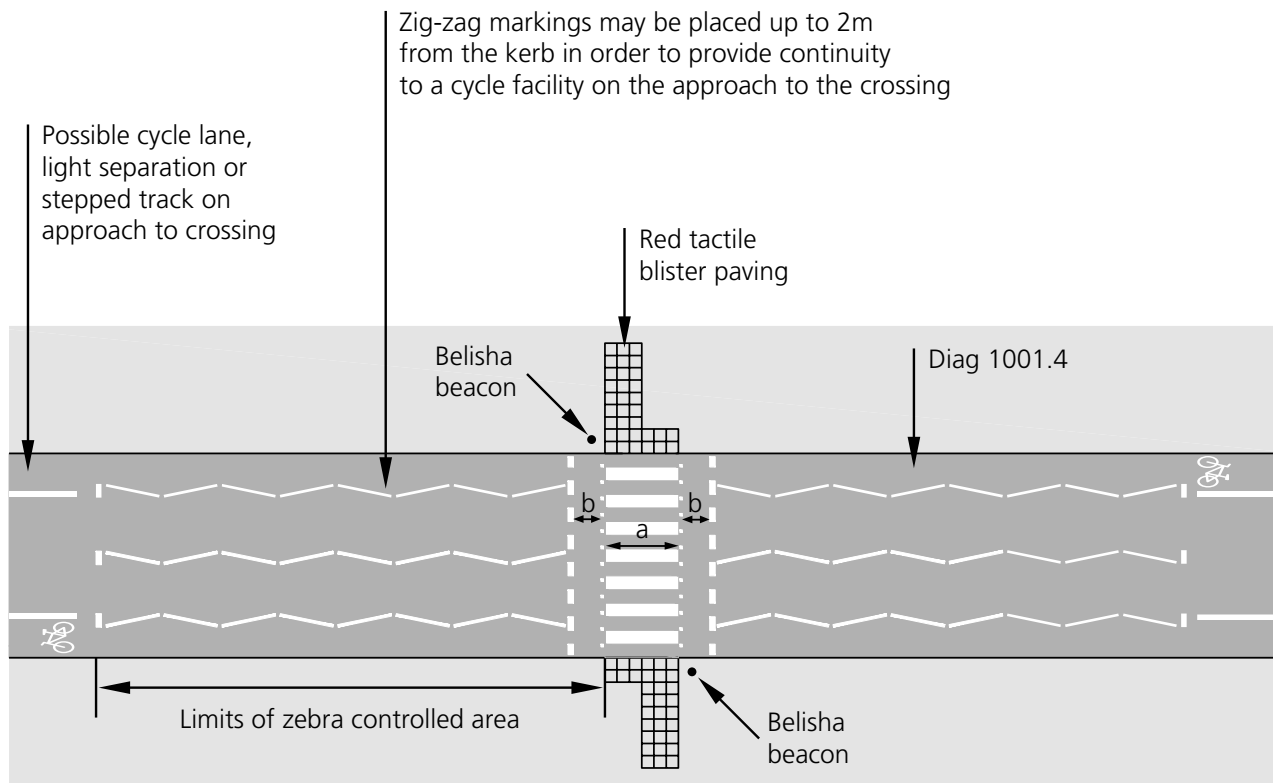

DE611 Parallel crossing for pedestrians and cyclists

Measure and brief description

A parallel crossing for pedestrians and cyclists is marked on the carriageway with transverse black and white stripes to indicate the pedestrian crossing and Elephants Footprint/Diagram 1057 markings to indicate the cycle crossing, together with yellow flashing globes (belisha beacons) on black and white striped poles at each side of the overall crossing. A driver must stop on the approach to the crossing when a pedestrian or cyclist starts to cross.

Benefits

- Parallel pedestrian/cycle crossings provide relatively low-cost facilities which give an immediate response to pedestrians' and cyclists' need to cross.
- They can be placed closer to junctions than signalised crossings, reducing the need to deviate from desire lines.
- Unless pedestrian or cycle flows are very high they result in lower delays to vehicles.

Key design features

- There should be adequate visibility to a crossing to ensure that approaching motorists can see a pedestrian or cyclist about to cross the road.
- Crossings may be sited on a flat-topped road hump (raised table) to slow traffic and highlight the presence of the crossing.
- Crossings may either cross a full width carriageway in a single stage or comprise two crossings with a central refuge.
- Crossings can be used across minor junctions close to the give way line.
- Crossings should be at least five metres from a side road junction, measured from the driver's position in the adjacent road.
- When provided on the approach or exit from a roundabout crossings should be located between 5m and 20m from the give way line.
- 8 zig zag markings are normally provided on either side of the crossing, which prevent parking, loading or overtaking. The maximum number is 18 and the minimum number is 2.
- Tactile paving to be provided.

Dimensions

- a – Pedestrian crossing width 4m minimum, 10m maximum.
- b – Distance of give way line to pedestrian crossing 1.1m minimum, 3m maximum.
- c – Distance between pedestrian and cycle crossing 0.4m.
- d – Cycle crossing width 1.5m minimum, 3.8m maximum.
- e – Distance of give way line to cycle crossing 0.8m.
- Zig zag markings can be placed up to 2.0m from the kerbline so that space for cycling can be maintained up to the crossing.

Other considerations

- A blind person would not start to cross until sure that vehicles have stopped and would therefore seek a pedestrian controlled signal crossing. Other groups of pedestrians, including people with learning disabilities and older people may feel safer and more comfortable using signalised crossings.
- Parallel crossings for pedestrians and cyclists are unsuitable in locations where the 85th percentile vehicle speed is greater than 35mph or where there would be regular congestion resulting from high vehicle or pedestrian flows.
- Where a crossing is used on a road of two lanes or more consideration should be given to whether a vehicle stopped in the nearside lane will obstruct visibility to a crossing pedestrian or cyclist from a vehicle in the off-side lane.
- Crossings may be divided by a refuge – see DE608.

DE611

Parallel crossing for pedestrians and cyclists

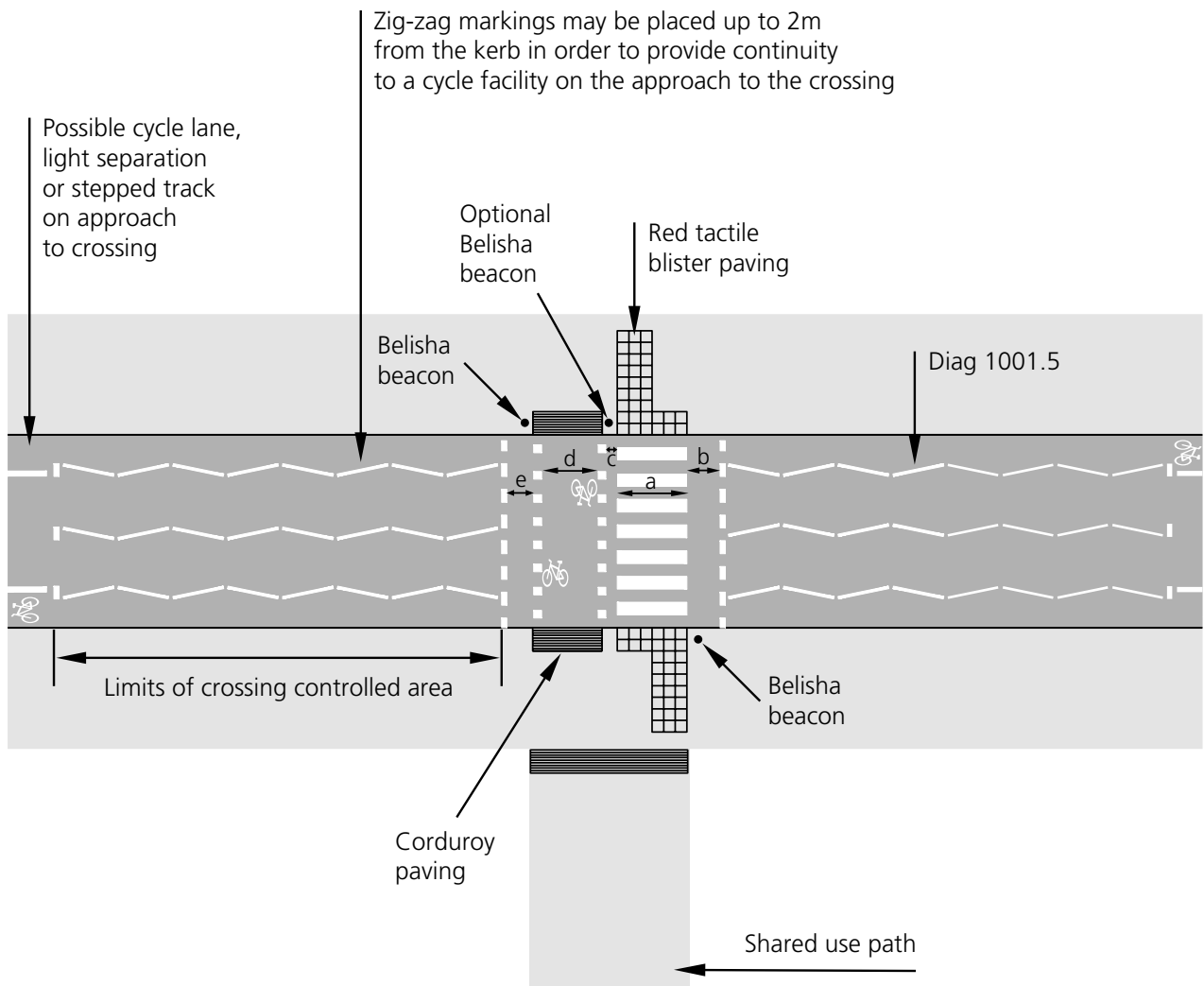

Llywodraeth Cymru
Welsh Government

DE number: DE611

Previous DE number: DE043

Do Not Scale Drawing

Revision number: 2

Copyright: Welsh Government

DE612 Puffin and ped-x crossings

Measure and brief description

Puffin and Ped-X crossings are signal-controlled pedestrian crossings. The traffic signal sequence is similar to a crossing facility at a signalised junction. Both types of crossing incorporate detection technology (usually infra-red) which allows cancellation of the pedestrian demand if a pedestrian crosses after pressing the button but before the green man has activated. Additionally, the detectors are used to measure the speed at which pedestrians are crossing and automatically adjust the time allowed to cross the road. Puffin crossings have nearside pedestrian red and green aspects located as part of or above the push button unit, and located so that they can be seen at the same time as approaching traffic. A Ped-X crossing is a newer type, similar to a Puffin crossing in terms of signal sequence and detection, but with far side pedestrian signal aspects. 'Countdown' displays which show the time in seconds to the end of the crossing period, can be used with Ped-X crossings, but in this case, on-crossing detection cannot be used as the clearance period is fixed. Pelican crossings are an obsolescent type of crossing with a flashing amber for drivers and flashing green man crossing period, which must not be used for new installations.

Benefits

- Signalled crossings are preferred by blind and partially sighted people, people with learning disabilities and other groups of pedestrians including older people.
- Puffin and Ped-X crossings include detector technology to extend the pedestrian crossing time so that people walking more slowly are not disadvantaged. Parallel pedestrian/cycle crossings provide relatively low-cost facilities which give an immediate response to pedestrians' and cyclists' need to cross.

Key design features

- Ped-X crossings with farside pedestrian signals are preferred by some users and are more suited to busy locations where pedestrians may have difficulty seeing the nearside indicators due to crowding.
- Signal-controlled pedestrian crossings may either cross a full width carriageway in a single stage or comprise two crossings with a central refuge.
- Crossings of single carriageways should preferably be single stage crossings with rapid push button response and recall timings.
- Single stage crossings are preferred, but two stage crossings can be provided and are often staggered to ensure that pedestrians treat each stage as a separate crossing, but straight-ahead divided crossings are much more convenient for pedestrians and should be used wherever possible. However, it will be important to avoid 'see-through' where pedestrians could mistake a green man on the far crossing for a green man on the near crossing.
- Two-stage straight ahead crossings can be achieved by using nearside pedestrian aspects, a wide central median or angling the crossings in preference to introducing a stagger.
- Where central waiting areas are created they should give maximum space and comfort to waiting users at peak times.
- The aim should be to minimise the time that pedestrians have to wait at a crossing. Where a crossing has two stages consideration should be given to including an advance call on the second crossing to minimise the time that a pedestrian has to wait for the second crossing.
- It is important that sufficient time is allocated to allow all pedestrians (particularly older people) to cross the road in an efficient unhurried manner.
- Crossings should reflect desire lines, using angled crossings if they are appropriate.
- Tactile paving and rotating cones for blind and partially sighted users to be provided.
- Audible signals should be considered but can be intrusive in residential areas.
- 8 zig zag markings are normally provided on either side of the crossing, which prevent parking, loading or overtaking. The maximum number is 18 and the minimum number is 2.

- Zig zag markings can be placed up to 2m from the kerbline so that space for cycling can be maintained up to the crossing. There should be adequate visibility to a crossing to ensure that approaching motorists can see a pedestrian or cyclist about to cross the road.

Dimensions

- a – Crossing width 2.4m minimum, 10m maximum.
- b – Distance of give way line to crossing studs 1.7m minimum, 3m maximum.

Other considerations

- Signal controlled crossings should generally be at least 20 metres from a side road junction.
- On the approach to or exit from a roundabout a non-staggered signal-controlled crossing should be sited either at 20 metres or more than 60 metres from the give way line. If the crossing is staggered, the crossing of the entry arm may be located between 20 metres and 60 metres from the give way line.
- The topography of the site needs to be such that the pedestrian detectors will operate satisfactorily.
- Care should be taken when locating signalled pedestrian crossings in close proximity to give-way junctions, particularly roundabouts, where the presence of the vehicle signals could be misinterpreted as giving priority at the give-way junction.
- Crossing points should remain free from street furniture and other clutter.
- Signalised crossings should not be used where 85th percentile speeds exceed 50mph.

Further References

- Department for Transport (2018) – Traffic Signs Manual.

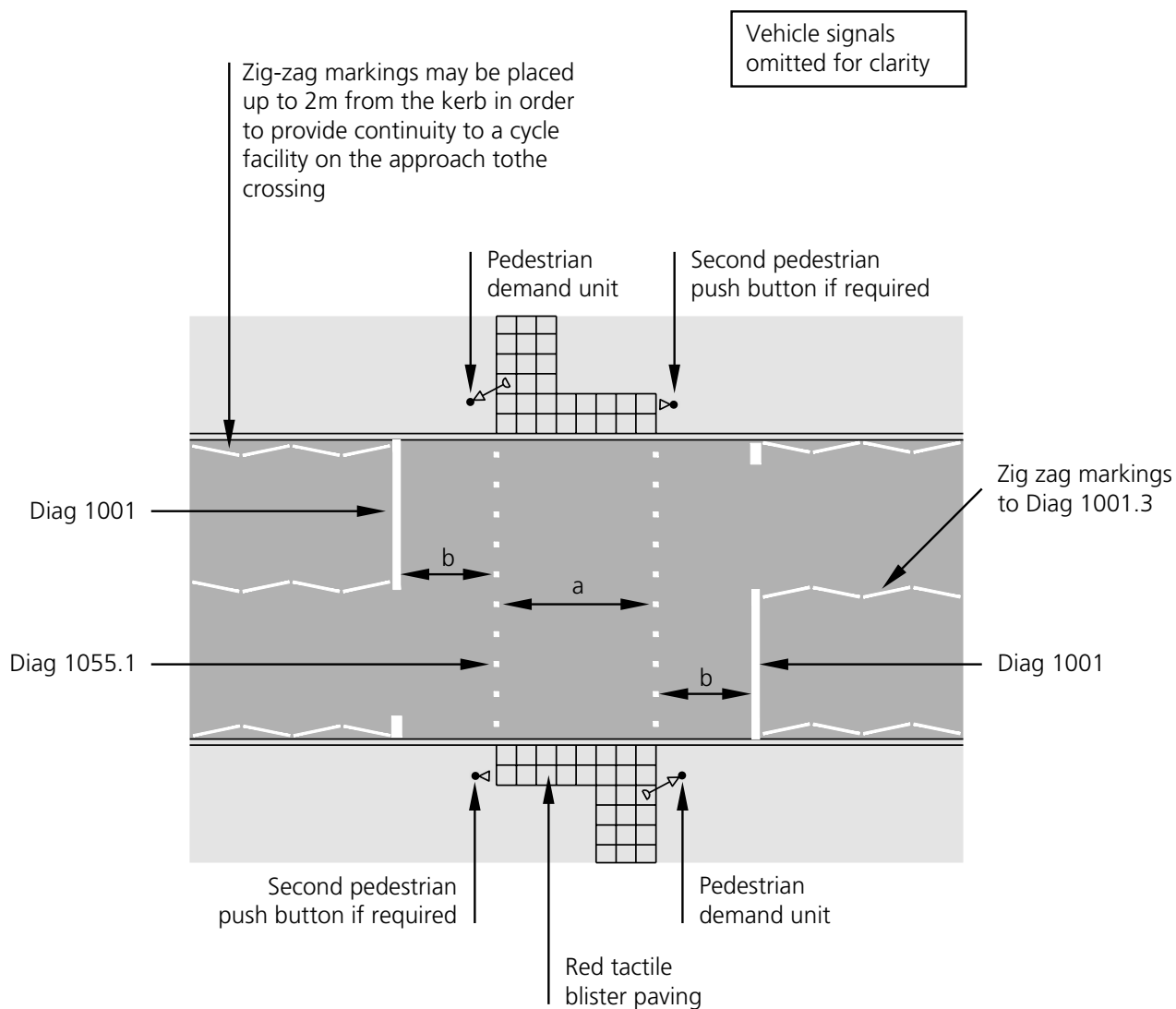

Notes

1. Ped-X crossing has farside pedestrian aspects instead of nearside.
2. Ped-X with 'Countdown' crossing is as Ped-X, with countdown display next to nearside pedestrian aspects.



DE613 Toucan crossing

Measure and brief description

A Toucan crossing is a signal-controlled pedestrian and cycle crossing. The traffic signal sequence is similar to a crossing facility at a signalised junction. Toucan crossings incorporate detection technology (usually infra-red) which allows cancellation of the pedestrian/cycle demand if a person crosses after pressing the button but before the green man has activated. Additionally, the detectors are used to measure the speed at which people are crossing and automatically adjust the time allowed to cross the road. Toucan crossings have nearside pedestrian/cycle red and green aspects located as part of or above the push button unit and located so that they can be seen at the same time as approaching traffic; farside aspects can also be used. Toucan crossings are used where there is a significant demand for cycle crossing movements over busy and faster roads, and a priority crossing (DE607) or parallel crossing for pedestrians and cyclists (DE611) is not suitable.

Benefits

- Toucans provide a compact crossing facility catering for both pedestrians and cyclists in one location
- Signalled crossings are preferred by blind and partially sighted people, people with learning disabilities and other groups of pedestrians including older people.
- Toucan crossings include detector technology to extend the pedestrian/cycle crossing time so that people travelling more slowly are not disadvantaged.

Key design features

- Crossings with farside pedestrian/cycle signals may be used at busy locations where people may have difficulty seeing the nearside indicators due to crowding.
- Toucan crossings may either cross a full width carriageway in a single stage or comprise two crossings with a central refuge.
- Crossings of single carriageways should preferably be single stage crossings with rapid push button response and recall timings.
- Where a Toucan crossing is required on a wide road, a single-stage crossing should generally be provided for widths below 15m. For widths over 15m, the option of a single-stage crossing should be fully considered in the light of existing examples.
- Staggered divided Toucan crossings very difficult for cyclists to use and should not normally be provided. Straight-ahead divided crossings are much more convenient for cyclists and should be used in preference. However, it will be important to avoid 'see-through' where users could mistake a green signal on the far crossing for a green signal on the near crossing.
- Two-stage straight ahead crossings can be achieved by using nearside pedestrian/cycle aspects, a wide central median or angling the crossings in preference to introducing a stagger.
- Where central waiting areas are created they should give maximum space and comfort to waiting users at peak times.
- The aim should be to minimise the time that pedestrians and cyclists have to wait at a crossing. Where a crossing has two stages consideration should be given to including an advance call on the second crossing to minimise the time that a pedestrian or cyclist has to wait for the second crossing.
- It is important that sufficient time is allocated to allow all pedestrians (particularly older people) to cross the road in an efficient unhurried manner.
- Designs should also take account of the demand for cyclists wishing to join or leave the carriageway at the crossing.
- Crossings should reflect desire lines, using angled crossings if they are appropriate.
- Tactile paving and rotating cones for blind and partially sighted users to be provided.
- Audible signals should be considered but can be intrusive in residential areas.

- 8 zig zag markings are normally provided on either side of the crossing, which prevent parking, loading or overtaking. The maximum number is 18 and the minimum number is 2.
- Zig zag markings can be placed up to 2.0m from the kerbline so that space for cycling can be maintained up to the crossing.

Dimensions

- a – Minimum recommended width of crossing is 4m, although where usage is low a 3m width is allowed. Maximum permitted width is 10m.
- b – Distance of stop line to crossing studs 1.7m minimum, 3m maximum.

Other considerations

- Signal controlled crossings should generally be at least 20 metres from a side road junction.
- On the approach to or exit from a roundabout a non-staggered signal-controlled crossing should be sited either at 20 metres or more than 60 metres from the give way line.
- When crossings are located close to a signal controlled junction, consideration should be given to linking the signals to the junction signals. The distance at which this should be considered will depend on traffic conditions but 100 metres is likely to be the minimum distance at which linking is required.
- The topography of the site needs to be such that the pedestrian detectors will operate satisfactorily.
- Toucans that have a long delay time before giving a green to cyclists cause frustration and can lead to frequent attempts to cross before the green light appears. Detection systems that identify approaching pedestrians and cyclists can speed up the countdown timer and reduce waiting times on the side of a busy or fast moving road.
- An additional set back push button can be considered to enable some users to access the crossings without encroaching in the carriageway.
- Crossing points should remain free from street furniture and other clutter.
- Signalised crossings should not be used where 85th percentile speeds exceed 50mph.

Further References

- Department for Transport (2018) – Traffic Signs Manual



Vehicle signals
omitted for clarity

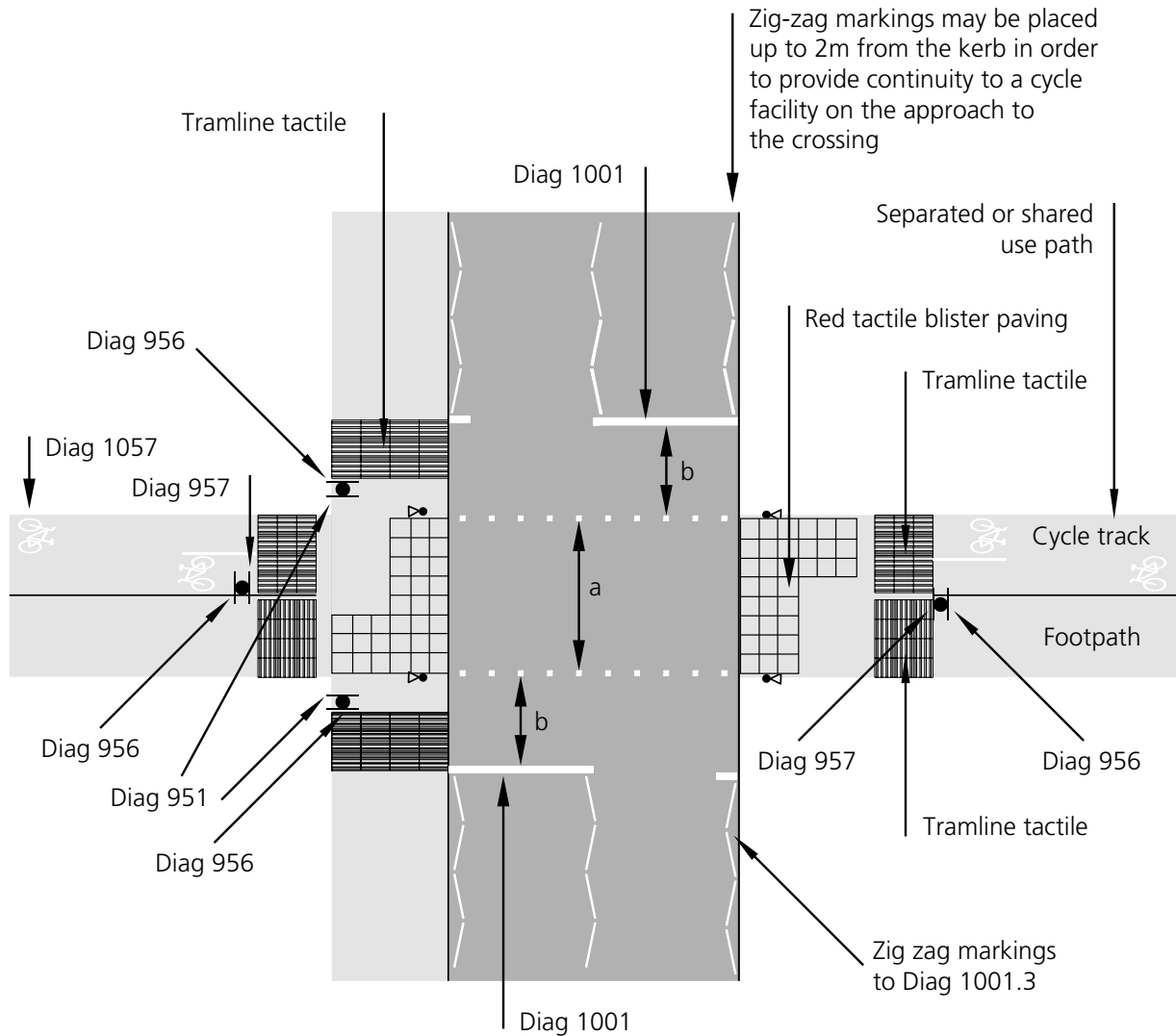

DE614 Advanced stop line

Measure and brief description

An Advanced Stop Line (ASL) enables cyclists to take up an appropriate position in the 'reservoir', or waiting area between the two stop lines, for their intended manoeuvre ahead of general traffic, before the signals change to green. A cycle feeder lane should normally be provided, which will enable cyclists to pass queuing motor traffic on the approach to the stop line. ASLs do not resolve all problems for cyclists at traffic signals. They are of no value when signals are already on green, and are inadequate for larger, complex junctions where cycle traffic should be given greater protection.

Benefits

- Feeder lanes allow cyclists to bypass waiting traffic, and get to the ASL reservoir at the head of the queue. Cyclists can position themselves where they are visible and in the correct turning lane. This is particularly helpful for cyclists making right turns and where there is a separately signalled left turn and cyclists wait to go ahead.
- ASLs can be used as a safe area for a cyclist to merge back into the carriageway from a cycle track.
- The ASL reservoir provides cyclists with an area free from exhaust fumes in which to wait.
- ASLs improve the comfort of pedestrians, by setting waiting motor traffic back from the pedestrian crossing.

Key design features

- The design of ASLs must be site-specific. Consideration should be given to factors such as the turning traffic volumes and dominant cycle movements, signal staging, location and number of approach lanes, and vehicle swept paths.
- Feeder lanes should be provided wherever possible and should preferably be mandatory, although a wide advisory cycle lane, accepting that some vehicles may encroach, may be better than a narrow mandatory lane.
- ASLs can also operate without feeder lanes, with 'gate' markings to diagram 1001.2A, but the benefit of an ASL is much reduced if no lead in lane is provided, since less confident cyclists will not try to reach the reservoir.
- Feeder lanes are normally located on the nearside. Centre and offside feeder lanes can also be provided to help cyclists make specific movements. For example where there is a heavy left-turning traffic movement which conflicts with a dominant ahead or right cycle movement, the feeder lane should be positioned between the left and ahead traffic lanes.
- Feeder lanes between traffic lanes need to be wider and this is generally achievable by narrowing the traffic lanes. Continuity of cycle lanes feeding ASLs should be maintained, with traffic having to cross the cycle lane to access the left turn lane.
- On approaches to ASLs, it is important that detection loops are positioned so that they cover the approach cycle lanes as well as the general traffic lanes. Often this is not the case, resulting in approaching cyclists not being detected. Similar considerations apply to above ground detection.
- Advanced stop lines can be partial width or have staggered stop lines. This is useful where right turns are not permitted (for cyclists or all vehicles), there are multiple right-turning lanes or tracking of vehicle movements into the arm of the junction shows that they would encroach on the ASL reservoir if it were full-width. There is some evidence that drivers are less likely to encroach into partial ASLs.
- Coloured surfacing should also be used to emphasise the reservoir, which can be full or part width.

Dimensions

- The recommended minimum length of the reservoir for cyclists is 5.0m - TSRGD permits a minimum of 4.0m. Longer reservoirs may be considered to satisfy demand, up to a maximum of 7.5m (or 10.0m with special authorisation).
- Nearside feeder lanes should normally be a minimum of 1.5m wide, and wider where possible. The absolute minimum width is 1.2m.
- Central and offside feeder lanes should be a minimum of 2m wide – absolute minimum 1.5m.
- General traffic lanes may be reduced to a minimum of 2.5m, which allows motor traffic not to block or encroach on the cycle lane.

Other considerations

- An 'early start' signal phase for cyclists can be used, using a low-level cycle signal (primary) and/or a 4th aspect 'cycle filter' (primary or secondary). It enables cyclists waiting in the reservoir to start (typically up to 7 seconds) ahead of other traffic and to clear locations of potential conflict with traffic on the same arm (e.g. overtaking and turning left) or opposing traffic streams.
- ASLs have little or no effect on capacity if the number of all-purpose traffic lanes remains unaltered.
- Care should also be taken at signals where there are large numbers of HGVs turning left because of the potential for cyclists to move into the driver's blind spot.

Further References

- Department for Transport (2018) – Traffic Signs Manual

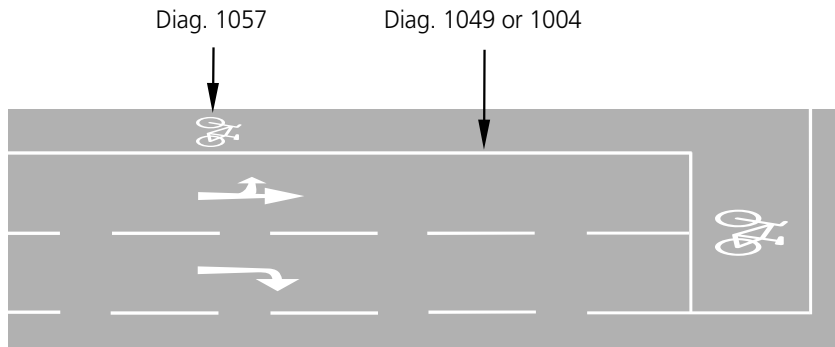

Nearside feeder lane

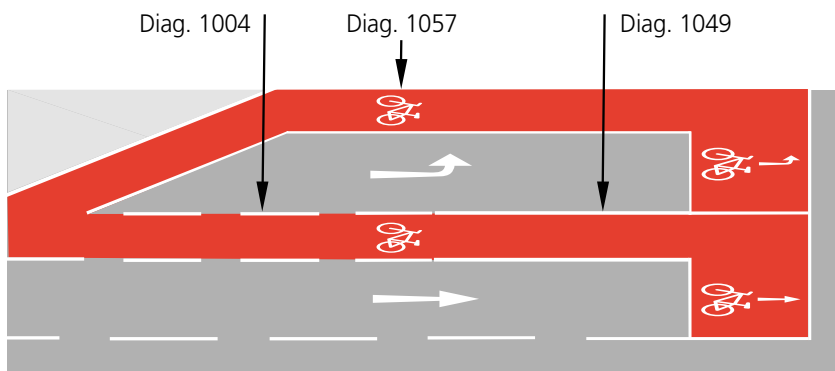

Nearside lane leading to central feeder lane

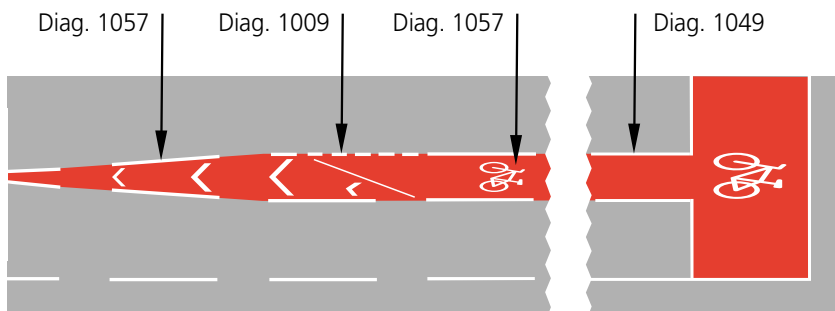

Central feeder lane

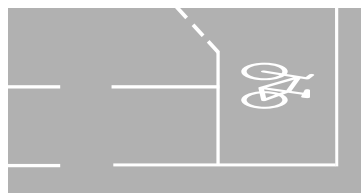

Gate feeder

Note - split ASLs and direction arrows not permitted without authorisation until revised TSRGD published



DE615 Cycle bypass at traffic signals

Measure and brief description

Where space and level of pedestrian use allow, it will be beneficial to cyclists to provide a slip off in advance of a signalised junction, leading to a short section of cycle track that enables the cyclist to bypass the red signal. This may be used to assist cyclists either to turn left or to continue straight ahead at the top of a T junction. Cycle bypasses can also be used as approach routes to cycle and pedestrian crossings in order to facilitate difficult manoeuvres (e.g. right turns) or to make manoeuvres which are prohibited to other traffic.

Benefits

- Reduce delays to cyclists and offer time advantages compared to other traffic.
- Formalise (and legalise) common cyclist behaviour.
- Enable cyclists to maintain momentum, improving comfort.
- Increases permeability where it enables cyclists to make manoeuvres that are prohibited for other modes.

Key design features

- Bypasses should be built within the carriageway so as not to impede pedestrian flows, but where this is impractical the bypass can be merged into a cycle track at or close to footway level.
- The design should make it clear if the facility is to be used in one or both directions.
- Cycle bypasses may, or may not, have their own set of signals phased to give early starts, or separate cycle phases. They may simply end at a give way line, discharge into a lane or track, or merge into general traffic.
- Loop detection on the approaches, and infra-red technology to detect waiting cyclists will help to speed up sequencing of traffic signals ahead.
- Careful design is required at pedestrian crossing locations.

Dimensions

- Minimum 2.0m wide track (a), 1.5m for short lengths.
- Margin strip (b) min 0.5m.

Other considerations

- Bypasses need to be designed to accommodate a variety of cycle types, and also be accessible to mini road sweepers.
- Poorly-accessible facilities will collect litter/broken glass and become unusable.
- A protected entry to the carriageway is preferred.

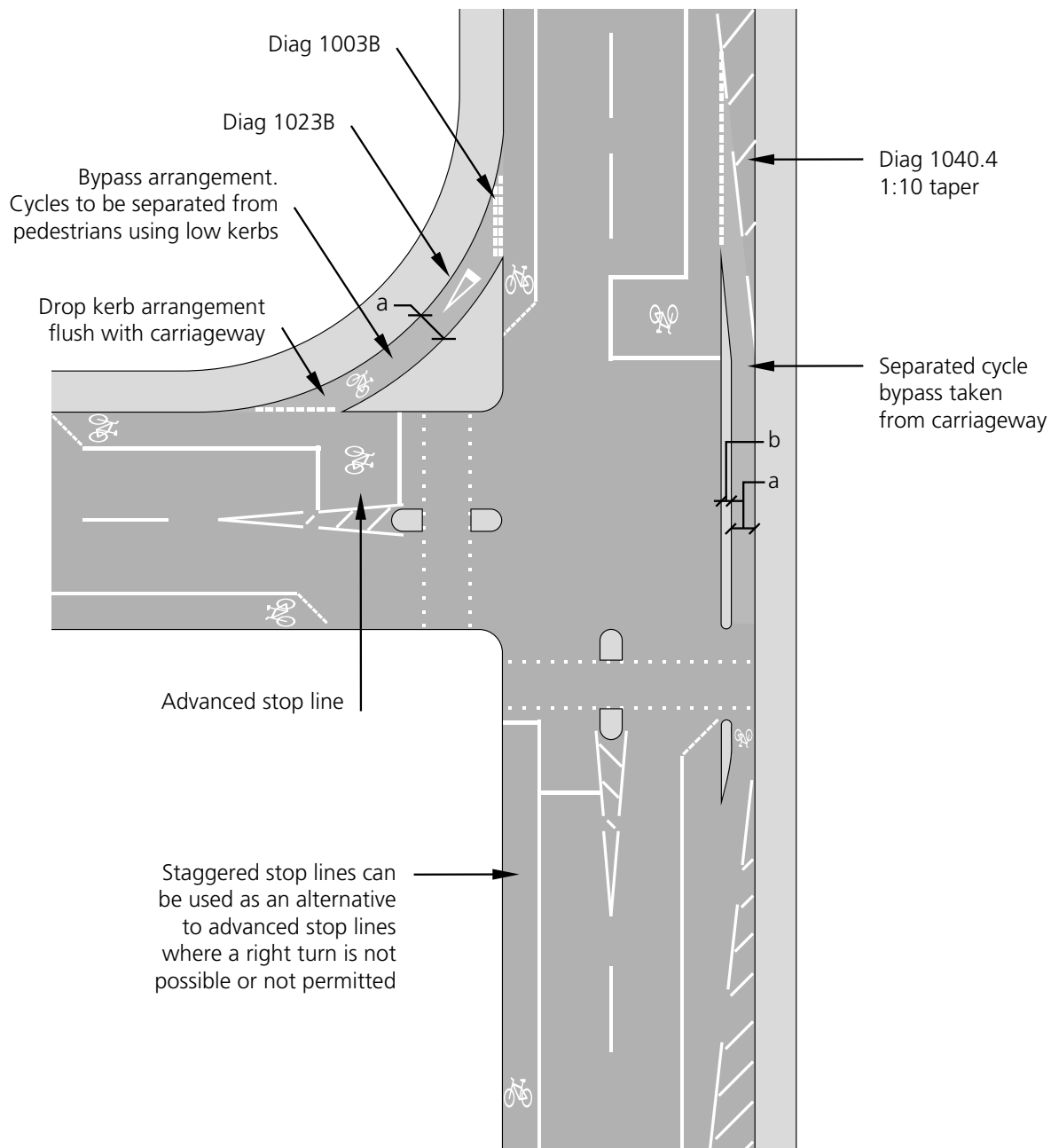

Note:

Tactile paving and signal heads omitted for clarity



DE616 Cycle lanes through signalised junction

Measure and brief description

A cycle lane marked through a signalised junction provides a visible indication of route continuity and increases drivers' awareness of key cycle movements. They are used to indicate route continuity and protect space for cyclist desire lines through major junctions on cycle routes.

Benefits

- Help to guide cyclists.
- Raise the awareness of motorists that a junction forms part of a recognised cycle route.
- They are particularly beneficial for large and complex junctions.

Key design features

- Route markings should comprise diag 1010 markings or alternatively advisory cycle lane markings (diag 1004).
- Consider highlighting with coloured surfacing.

Dimensions

- a – width of cycle lane on approaches refer to DE303 and DE304.
- b – width of cycle lane through junction to be at least 0.5m wider than the approach cycle lane, minimum 2m is recommended.
- Where movements are generally straight ahead, and traffic passes cyclists on the riders' right.
- Minimum width lanes of 2.5m are recommended where traffic can be moving on both sides of the cyclist.

Other considerations

- Where cyclists have several cross cutting desire lines through a junction, attempting to mark these may be confusing and counter-productive.
- Route markings through junctions will be subject to high levels of wear and will require maintenance.

DE616

Cycle lanes through signalised junction

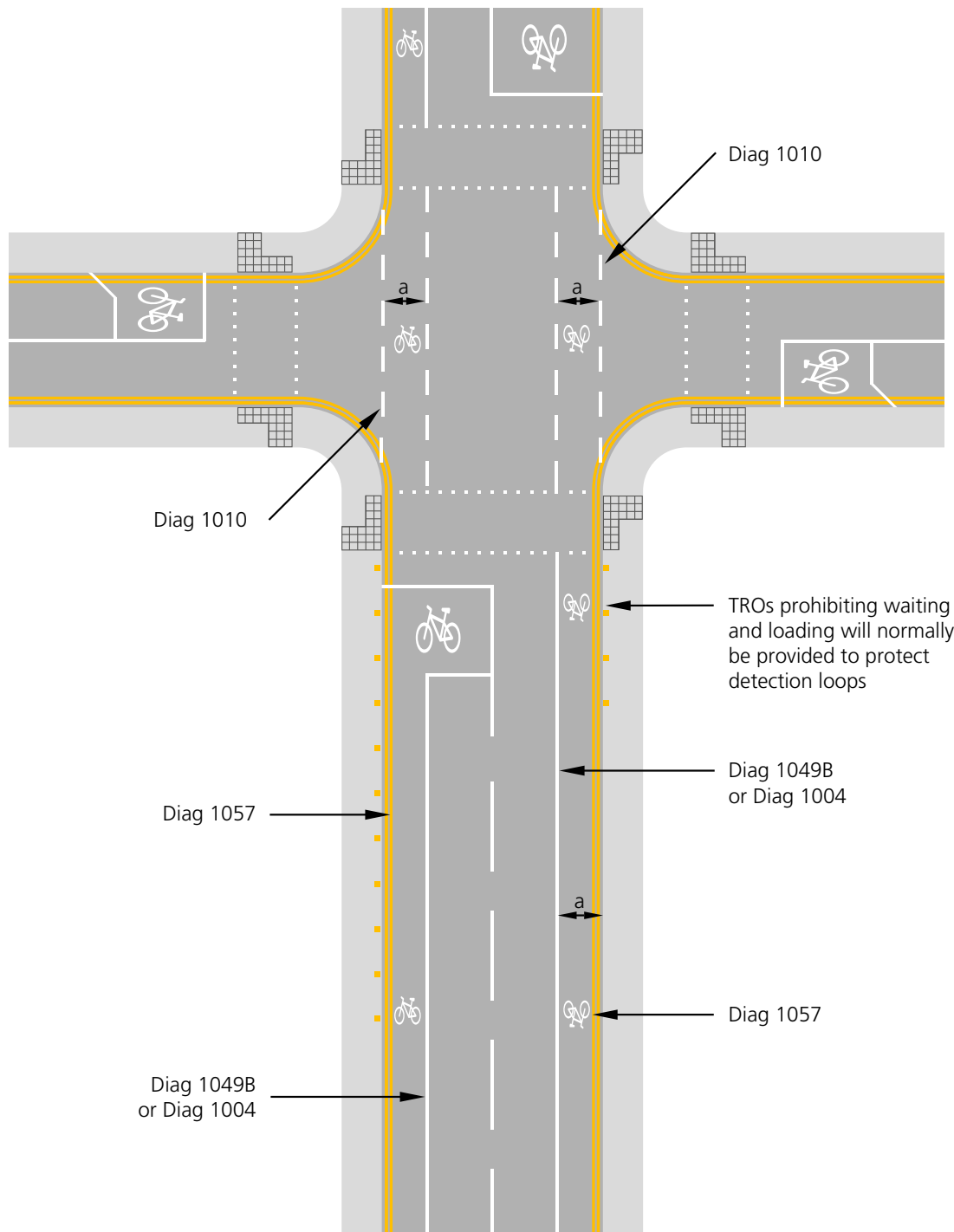

Llywodraeth Cymru
Welsh Government

DE number: DE616

Previous DE number: DE052

Do Not Scale Drawing

Revision number: 2

Copyright: Welsh Government

DE617 Two stage right turn at traffic signals

Measure and brief description

This design provides for cyclists turning right at a multi-lane approach to a signalised junction, where the speed and volume of motor traffic makes the execution of a conventional right turn hazardous and unpleasant, even when an ASL is provided. Provision is made for cyclists to pull in to the side road on their left and wait there until the side road has a green light, at which point cyclists can make a straight across movement to complete their right turn.

Benefits

- Cyclists able to make a safe right turn off a busy road, without having to weave across traffic lanes.

Key design features

- The waiting area can be marked with a cycle symbol (diag 1057) and right turn arrow (diag 1059), backed with coloured surfacing if needed.
- The waiting area must be clear of any pedestrian crossing on the side road and sufficiently far back from ahead traffic on the main road for cyclists waiting there to feel safe. It should be clear of any cycle lane across the junction.
- Waiting area should to be of sufficient size for the number of cyclists waiting to turn.
- Cyclists rely on the secondary signal on the side road to know when they can make the second stage of the turn, so this must be located where cyclists can see it.

Dimensions

- a – width of cycle lane on approaches refer to DE303 and DE304.
- b – width of cycle lane through junction to be at least 0.5m wider than the approach cycle lane.
- Minimum 2m is recommended where movements are generally straight ahead, and traffic passes cyclists on the riders' right.
- Minimum width lanes of 2.5m are recommended where traffic can be moving on both sides of the cyclist.

Other considerations

- Where cyclists have several cross cutting desire lines through a junction, attempting to mark these may be confusing and counter-productive.
- Route markings through junctions will be subject to high levels of wear and will require maintenance.

DE617

Two stage right turn at traffic signals

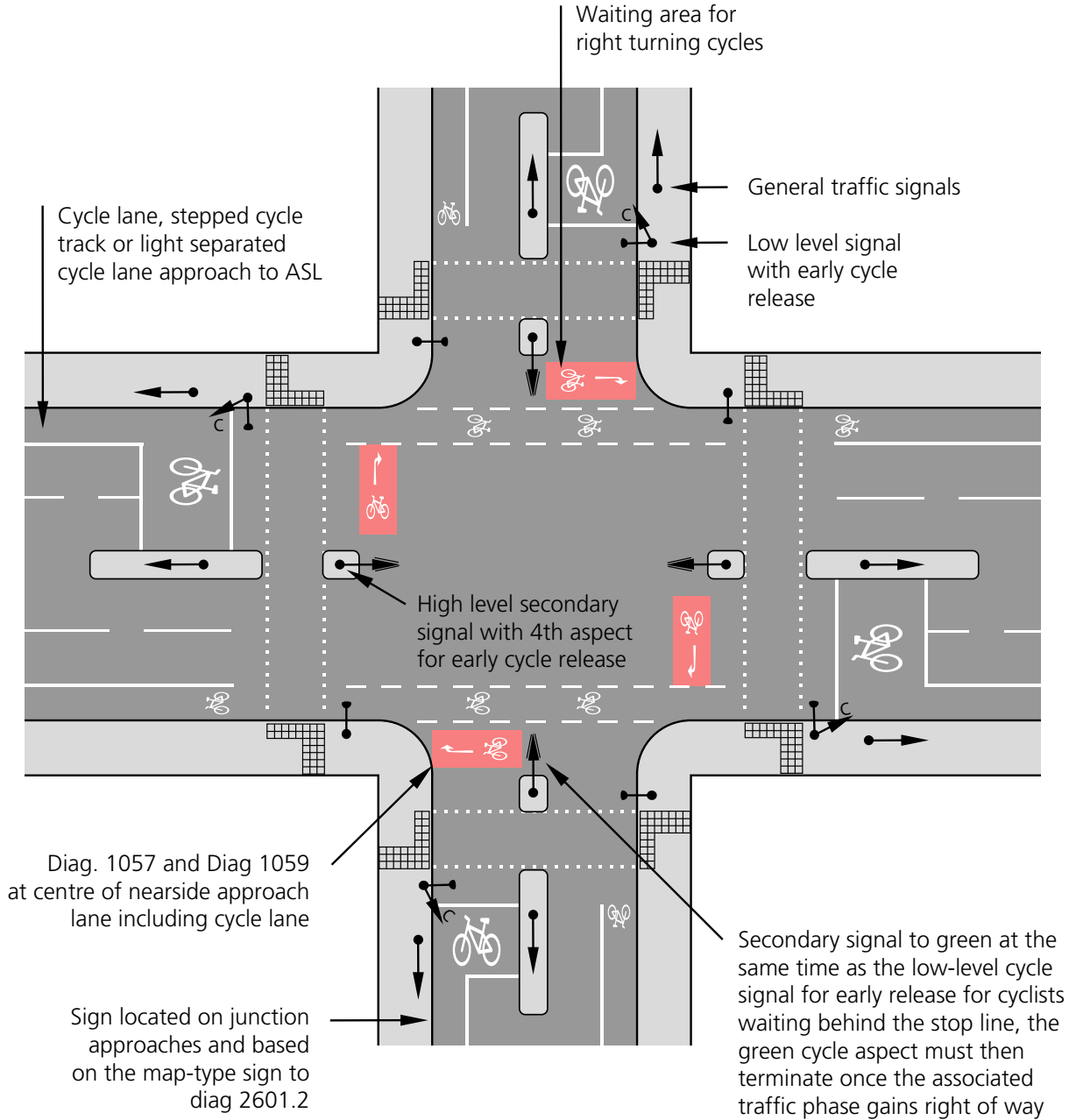

Llywodraeth Cymru
Welsh Government

DE number: DE617

Previous DE number: DE053

Do Not Scale Drawing

Revision number: 2

Copyright: Welsh Government

DE618 Hold the left turn

Measure and brief description

A cycle lane marked through a signalised junction provides a visible indication of route continuity and increases drivers' awareness of key cycle movements. They are used to indicate route continuity and protect space for cyclist desire lines through major junctions on cycle routes.

Benefits

- Help to guide cyclists.
- Raise the awareness of motorists that a junction forms part of a recognised cycle route.
- They are particularly beneficial for large and complex junctions.

Key design features

- Route markings should comprise diag 1010 markings* or alternatively advisory cycle lane markings (diag 1004).
- Consider highlighting with coloured surfacing.

Dimensions

- a – width of cycle lane on approaches refer to DE303 and DE304.
- b – width of cycle lane through junction to be at least 0.5m wider than the approach cycle lane.
- Minimum 2m is recommended where movements are generally straight ahead, and traffic passes cyclists on the riders' right.
- Minimum width lanes of 2.5m are recommended where traffic can be moving on both sides of the cyclist.

Other considerations

- Where cyclists have several cross cutting desire lines through a junction, attempting to mark these may be confusing and counter-productive.
- route markings through junctions will be subject to high levels of wear and will require maintenance.

DE618

Hold the left turn

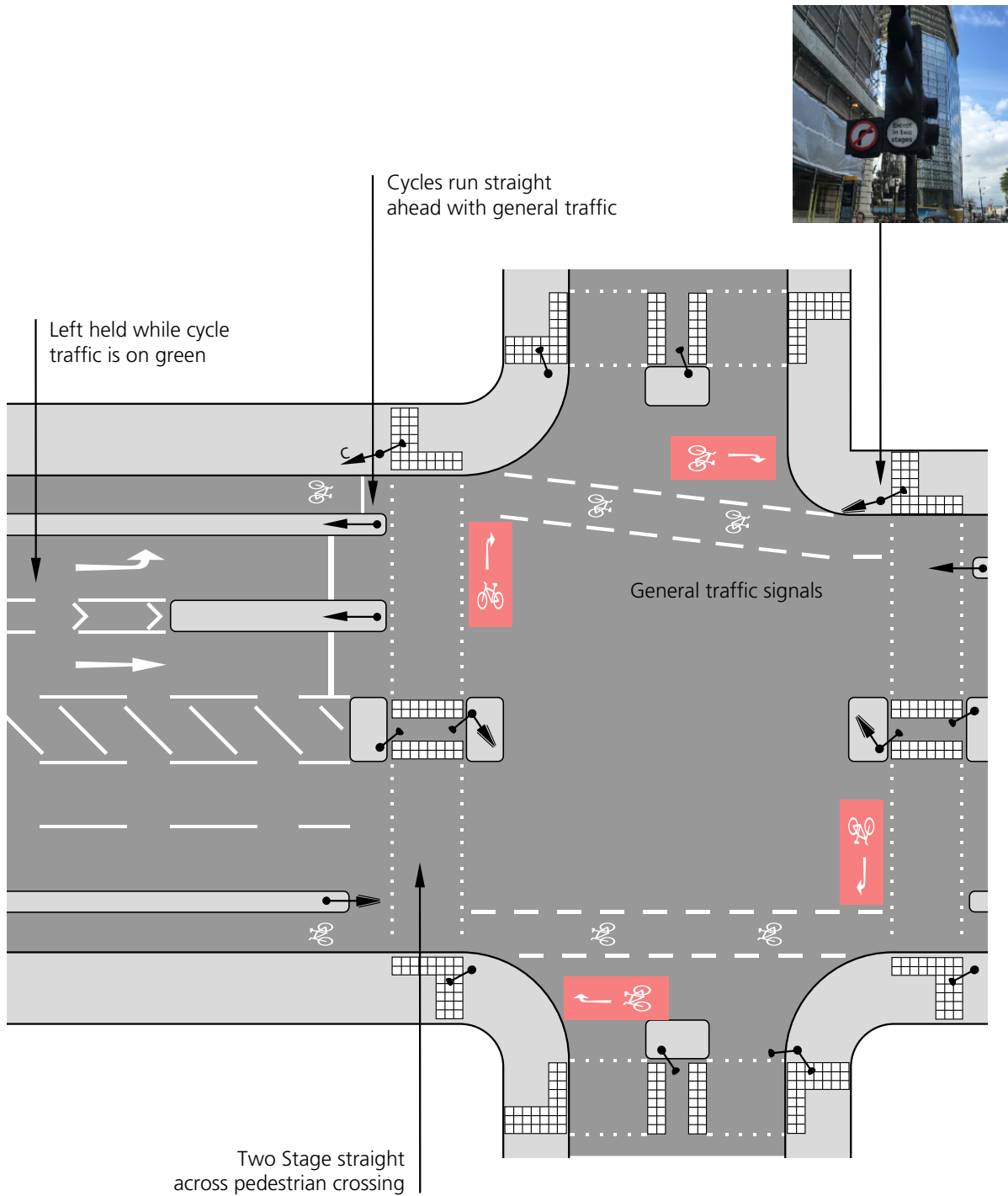

Llywodraeth Cymru
Welsh Government

DE number: DE618

Previous DE number: DE054

Do Not Scale Drawing

Revision number: 2

Copyright: Welsh Government

DE619 Protected junction

Measure and brief description

A cycle lane marked through a signalised junction provides a visible indication of route continuity and increases drivers' awareness of key cycle movements. They are used to indicate route continuity and protect space for cyclist desire lines through major junctions on cycle routes.

Benefits

- Help to guide cyclists.
- Raise the awareness of motorists that a junction forms part of a recognised cycle route.
- They are particularly beneficial for large and complex junctions.

Key design features

- Route markings should comprise diag 1010 markings* or alternatively advisory cycle lane markings (diag 1004).
- Consider highlighting with coloured surfacing.

Dimensions

- a – width of cycle lane on approaches refer to DE303 and DE304.
- b – width of cycle lane through junction to be at least 0.5m wider than the approach cycle lane.
- Minimum 2m is recommended where movements are generally straight ahead, and traffic passes cyclists on the riders' right.
- Minimum width lanes of 2.5m are recommended where traffic can be moving on both sides of the cyclist.

Other considerations

- Where cyclists have several cross cutting desire lines through a junction, attempting to mark these may be confusing and counter-productive.
- Route markings through junctions will be subject to high levels of wear and will require maintenance.

DE619

Protected junction

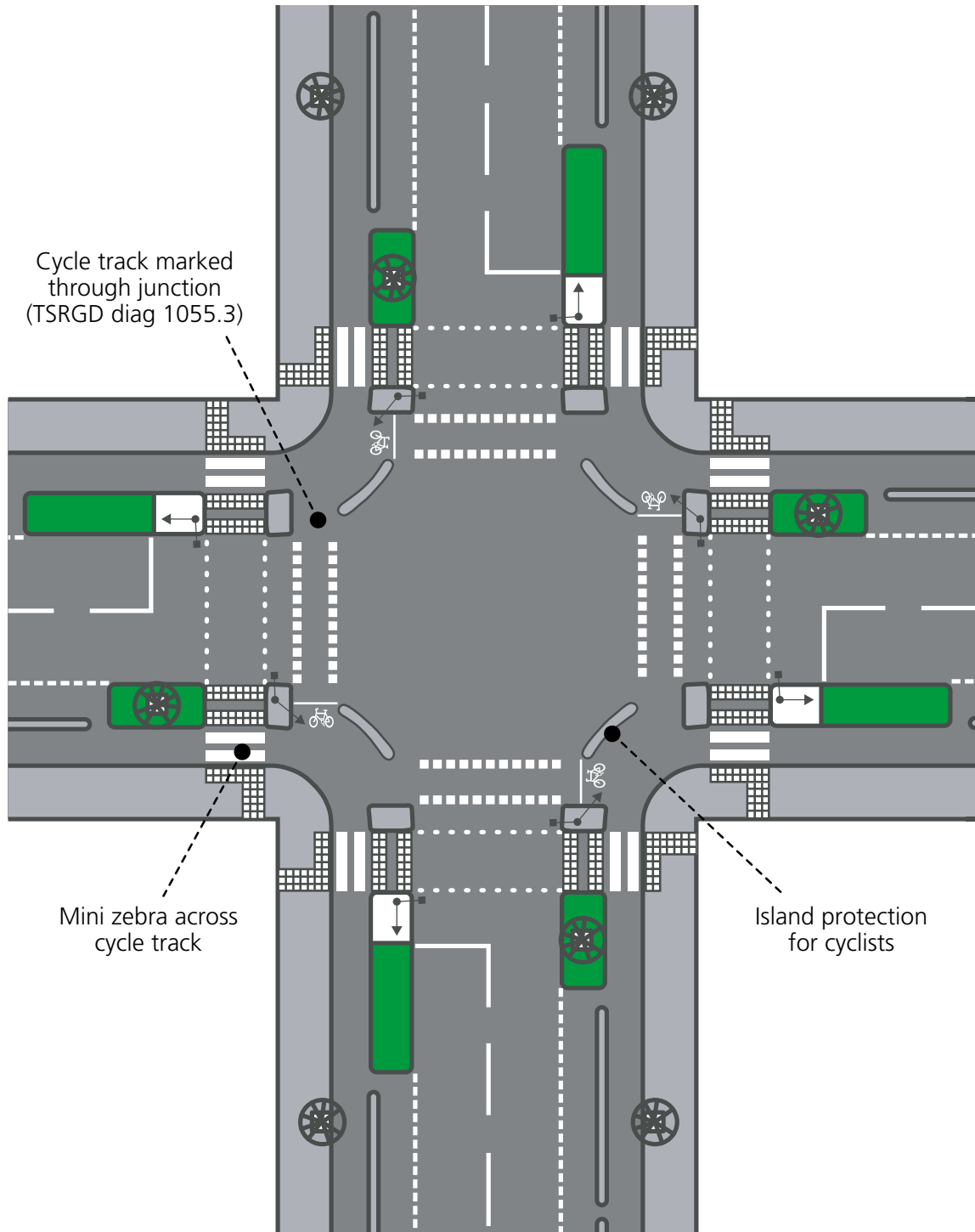

Llywodraeth Cymru
Welsh Government

DE number: DE619

Previous DE number: DE055

Do Not Scale Drawing

Revision number: 2

Copyright: Welsh Government

DE620 Cycle track alongside one-way carriageway at cross-roads

Measure and brief description

This detail and plan is provided to assist with the design options process and will need to be amended to suit each particular junction or crossing.

Benefits

- Cycle and pedestrian traffic is able to make a full range of movements through the junction with physical separation and at different stages from motorised traffic.

Key design features

- Tactile paving is used to guide pedestrians to the crossing facilities.
- Pedestrians cross the cycle track and carriageway in one stage.
- The cycle route along the primary road is marked through the junction with elephants footprints and coloured surfacing.
- Low-level cycle signals can be used at the stop lines for the cycle track and as repeaters by the advanced stop lines.

Dimensions

- Pedestrian crossing area should normally be 3.0m minimum width, cycle lanes and pedestrian refuge areas 2.0m width, and two-way cycle tracks a desirable minimum 3.0m width.
- Advanced stop lines should be arranged as in DE614.

Other considerations

- Surface markings on the carriageway at junctions will be subject to high levels of wear and will require maintenance.

DE620

Cycle track alongside one-way carriageway at cross-roads

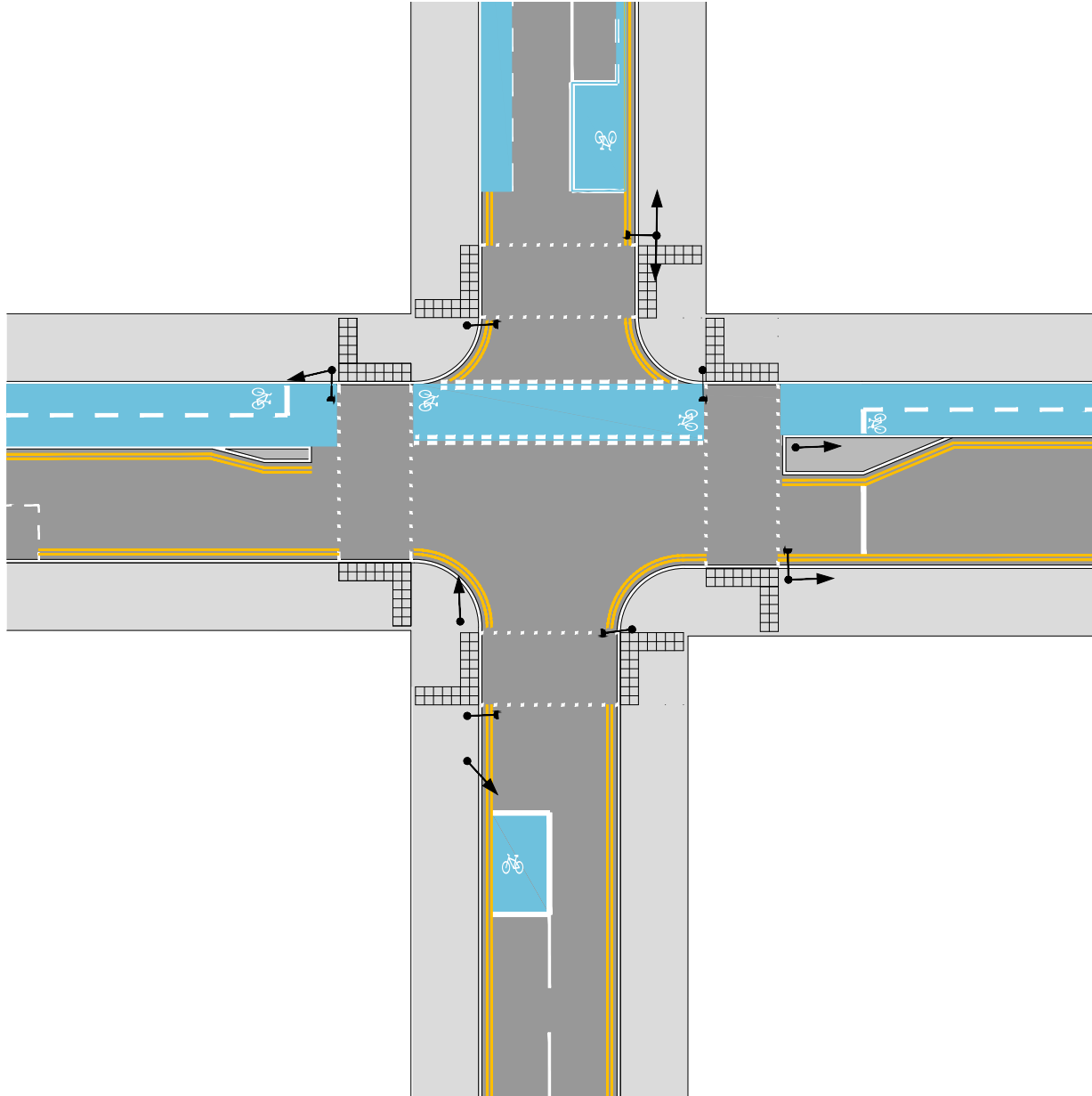

Llywodraeth Cymru
Welsh Government

DE number: DE620

Do Not Scale Drawing

Copyright: Welsh Government

Previous DE number:

Revision number: 1

DE621 Parallel signalled controlled crossing

Measure and brief description

This drawing shows a signal controlled crossing arrangement where a two way cycle track swaps from one side of the road to the other. The arrangement enables pedestrian and cycle traffic to cross in the same stage, but with physical separation from each other.

This detail and plan is provided to assist with the design options process and will need to be amended to suit each particular junction or crossing.

Benefits

- The facility provides a way for cycle and pedestrian traffic to be protected at the point where a facility swaps from one side of the road to the other.
- Pedestrian and cycle traffic is separated unlike at a Toucan crossing.

Key design features

- Tactile paving should be used to guide pedestrians.
- The cycle track should be flush with carriageway at the point of intersection.
- The cycle crossing is marked by Elephants Footprint markings (if coloured surfacing is being used on the cycle track links this could also be used within the crossing area)
- Loop detectors and auxiliary push-buttons can be used to call the cycle crossing signal.

Dimensions

- Cycle lanes, footways and pedestrian refuge areas 2.0m width, two-way cycle tracks a desirable minimum 3.0m width.
- Pedestrian crossing arranged as in DE612.

Other considerations

- Depending on the exact arrangement, the pedestrian crossing of the cycle track may be either signal controlled or use a zebra crossing.
- A small flat-topped hump can be placed on the cycle track at the area where pedestrians cross to ensure cyclists slow down and give way to pedestrians.
- Special authorization is required if the cycle track crosses the carriageway at an angle.

DE621

Parallel signalled controlled crossing

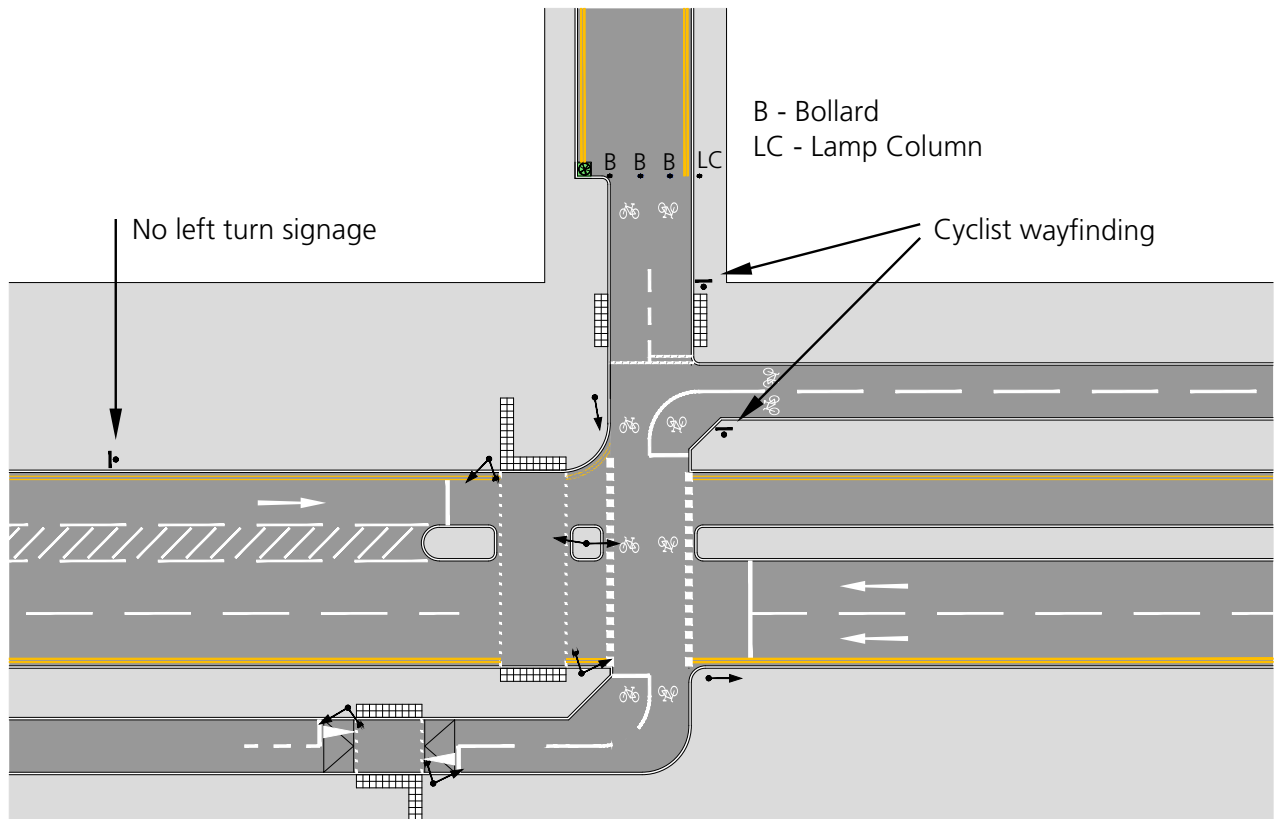

Llywodraeth Cymru
Welsh Government

DE number: DE621

Do Not Scale Drawing

Copyright: Welsh Government

Previous DE number:

Revision number: 1

DE622 Two-way cycle track at larger cross-roads

Measure and brief description

This drawing shows the potential arrangement to accommodate all movements where a two-way cycle track along a main road intersects with a minor road where there is on-carriageway cycling. The junction is signal controlled, with advanced stop lines for cyclists on the minor arms and signal control of the cycle track. Pedestrian crossing areas are also signal controlled.

This detail and plan is provided to assist with the design options process and will need to be amended to suit each particular junction or crossing.

Benefits

- Cycle and pedestrian traffic is able to make a full range of movements through the junction with physical separation and at different stages from motorized traffic.

Key design features

- Tactile paving is used to guide pedestrians to the crossing facilities.
- Pedestrians cross the cycle track and carriageway in one stage.
- Cycle traffic turning across the main road carriageway into the minor road does so from a turning pocket marked in the carriageway.
- Low-level cycle signals can be used at the stop lines for the cycle traffic.

Dimensions

- Pedestrian crossing area should normally be 3.0m minimum width, cycle lanes and pedestrian refuge areas 2.0m width, and two-way cycle tracks 3.0m desirable width.
- Advanced stop lines should be arranged as in DE614.

Other considerations

- Surface markings at junctions will be subject to high levels of wear and will require maintenance.
- The number of signalling stages required will add to delay for all users. This could lead to compliance issues with pedestrian and cycle traffic using intergreen time to cross rather than waiting for their turn in the staging, particularly in quieter periods when there is less opposing traffic.

DE622

Two-way cycle track at larger cross-roads

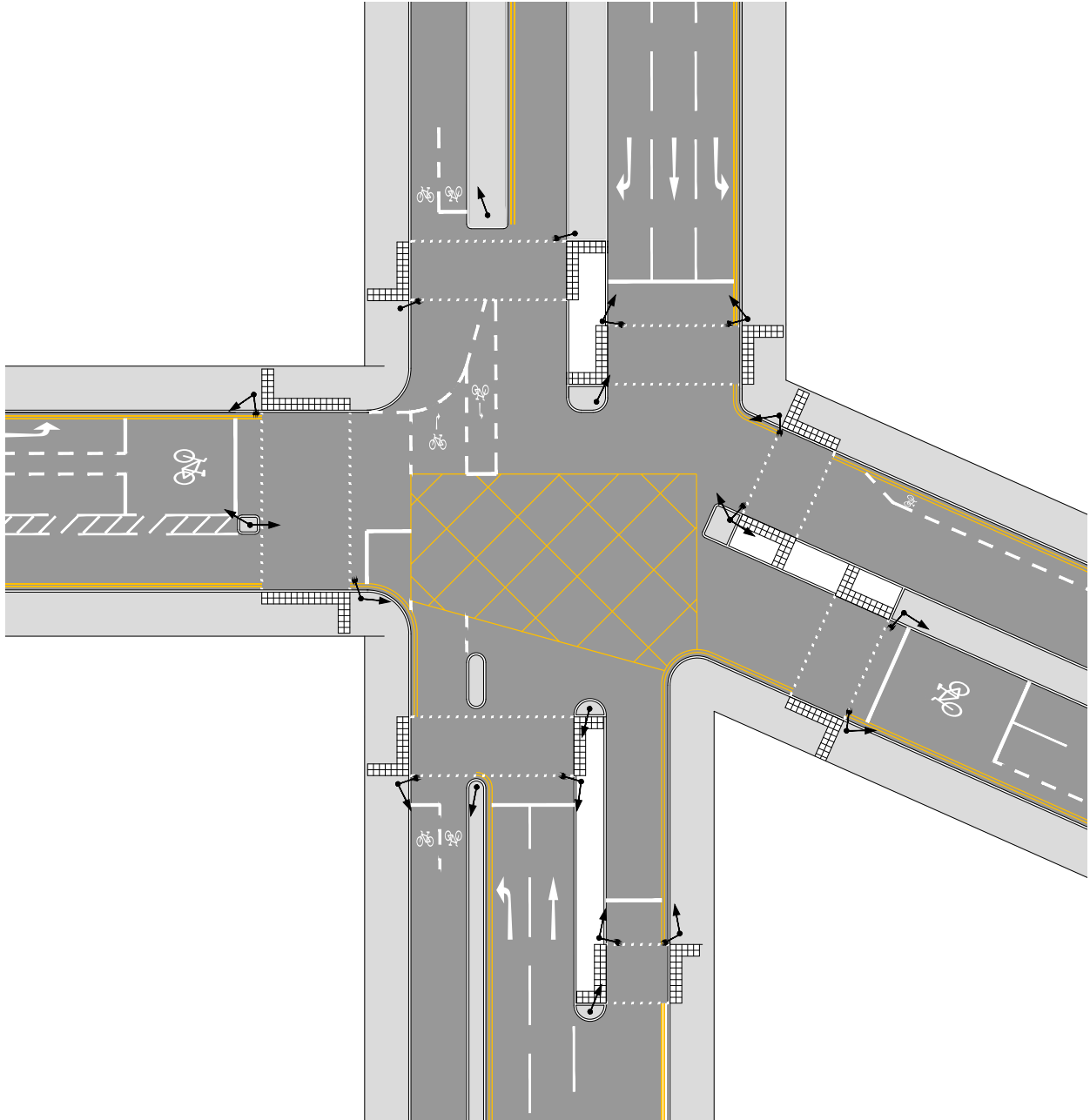

Llywodraeth Cymru
Welsh Government

DE number: DE622

Do Not Scale Drawing

Copyright: Welsh Government

Previous DE number:

Revision number: 1

DE623 Mini roundabout

Measure and brief description

Mini roundabouts with an inscribed circle diameter not greater than 15m, can be good alternatives to retaining priority junctions when traffic volumes are relatively low and speeds are slow. By providing tighter radii they contribute to achieving slower vehicle speeds, and can be included in traffic calming schemes. Single lane approaches mean that cyclists and motor vehicles pass through the roundabout in a single stream. They can be a compact and low cost solution to improving junction capacity where traffic signals are not preferred.

Benefits

- Single circulatory carriageway puts cyclists in drivers' line of sight.
- Traffic calming effect, especially where they are installed on raised tables.
- Slower speeds which aids cyclists' comfort and safety, especially those wanting to turn right.
- Potential reduction in traffic delay compared to priority junctions.

Key design features

- Single lane entries and exits.
- Domed central roundel.
- Deflection of traffic.
- Any cycle lanes on approaches should end 20-30m in advance of the give way line so that cyclists mix with traffic on the junction approach.

Dimensions

- Outer radius (R1) 5m-7.5m.
- Radius of central roundel (R2) 0.5m-2m.

Other considerations

- Consider incorporating a raised table.
- Consider incorporating deflector islands.
- Busier four arm and combinations of double roundabouts can be uncomfortable and less safe from a cyclist's perspective.
- The impact upon and the ability of pedestrians to cross the carriageway.
- Impact on long vehicles and buses may be an issue.

Further References

- Welsh Government (2019) - DMRB CD116, Geometric Design of Roundabouts.



Diag 602 and optional Diag 1023 where deflection on approach is limited, with Diag 1003A give way marking



Diag 611.1

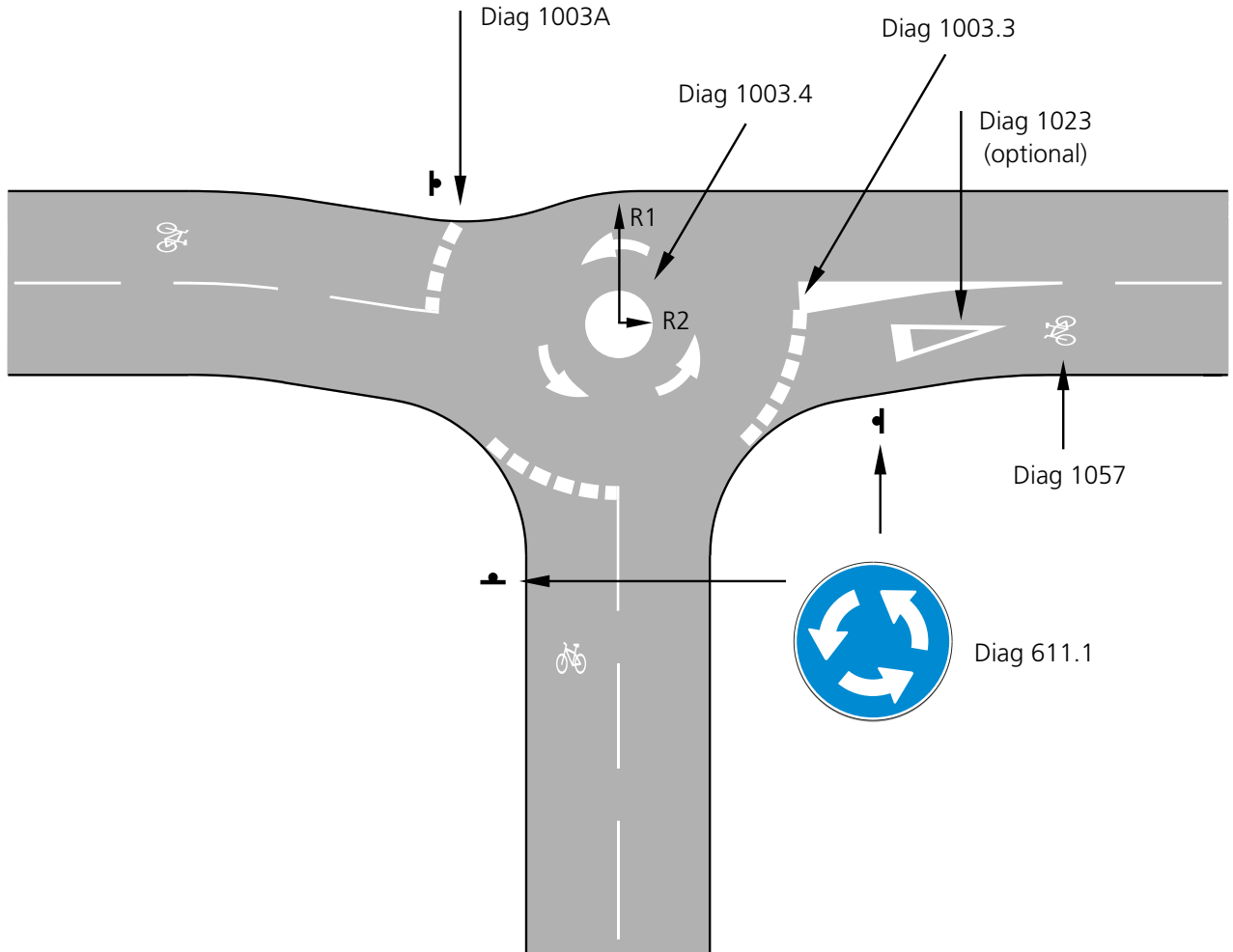

DE624 Compact 'continental' roundabout

Measure and brief description

Based on a standard feature at junctions in Denmark and other countries, this design provides for cyclists turning right at a multi-lane approach to a signal controlled junction, where the speed and volume of motor traffic makes the execution of a conventional right turn hazardous and unpleasant, even when an ASL is provided. Provision is made for cyclists to pull in to the side road on their left and wait there until the side road has a green light, at which point cyclists can make a straight across movement to complete their right turn.

Benefits

- Single circulatory carriageway puts cyclists in drivers' line of sight.
- Tighter geometry at entry, circulatory carriageway and exit results in slower vehicle speeds.
- Slower speeds which aids cyclists' comfort and safety, especially those wanting to turn right.

Key design features

- Perpendicular entry and exit arms.
- Single lane entries, circulatory carriageway and exit.
- Any cycle lanes on approaches should end 20-30m in advance of the give way line so that cyclists mix with other traffic on the junction approach.

Dimensions

- R1 – Outer radius of Inscribed Circle 10m-20m.
- R2 – Radius of over-run area 6.5m-15m.
- B1 – Width of over-run area 1m-1.5m.
- B2 – Width of circulatory carriageway 4.5m-6m.
- E1 – Entry radius 12m max.
- E2 – Exit radius 15m max.

Other considerations

- Suitable for speed limits up to 40mph.
- Roundabout capacity is typically approx. 25,000 AADT, but Dutch guidance is that above 6,000 AADT a separate cycle track should be provided. This guidance recommends that where the roundabout carries over 8,000 AADT consideration must be given to providing off-carriageway tracks for cyclists (see DE625).
- Depending on layout, overall junction size and swept path requirements, it may be necessary for the roundabout to have 're-entrant' kerblines on the outside edge of the circulatory carriageway to maintain tight entries and exits.
- Where a peripheral cycle track is appropriate, the aim should be to include cycle priority on each arm.
- Clutter-free (eg guard railing) median islands on the junction arms will act as refuges for pedestrian and cyclist crossing movements and improve visibility and the streetscene.
- Zebra, parallel pedestrian/cycle or informal crossings can be placed close to the give way lines on direct desire lines.
- Street lighting must be provided.

Further References

- Department for Transport (1997) – Traffic Advisory Leaflet 9/97, Cyclists at Roundabouts – Continental Design Geometry.
- Welsh Government (2019) - DMRB CD116, Geometric Design of Roundabouts.

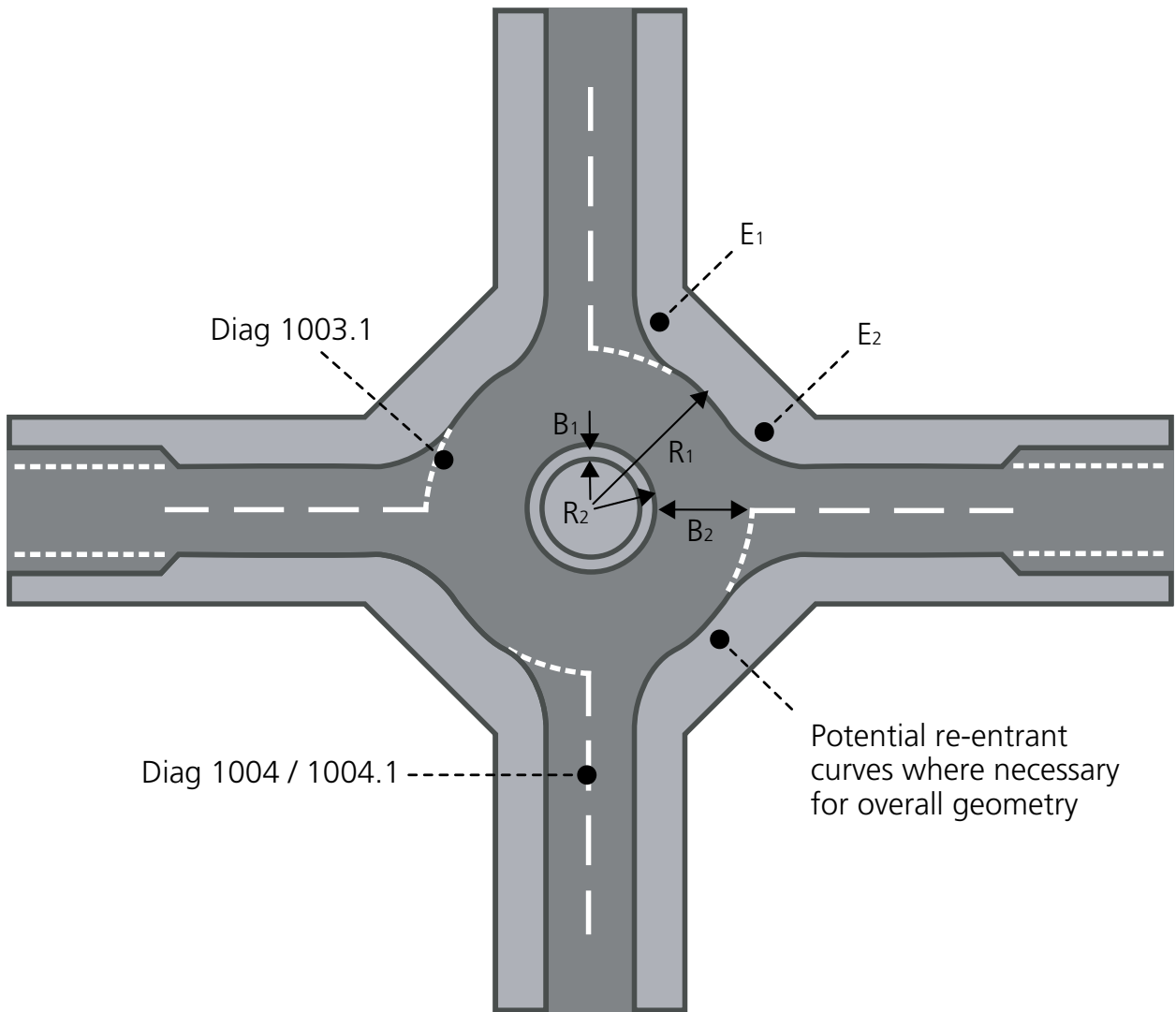

DE625 Dutch style roundabout with cycle track priority

Measure and brief description

This roundabout is based on a design in common use in the Netherlands. It has the continental geometry with arms that are aligned in a radial pattern, with unflared, single lane entries and exits, and a single lane circulatory carriageway. This is used in combination with parallel cycle-zebra crossings of each arm, thus enabling cyclists to circulate with priority. It is suitable where speed limits are 30mph or less.

Benefits

- Cyclists not mixing with circulating motor traffic.
- Tighter geometry at entry, circulatory carriageway and exit results in slower vehicle speeds.
- Cycle priority clearly marked with parallel crossing arrangements.

Key design features

- Perpendicular entry and exit arms.
- Single lane entries, circulatory carriageway and exit.
- At least 5m setback to crossing facilities (one vehicle length).

Other considerations

- Suitable for speed limits up to 30mph.
- Dutch guidance is that above 6,000 AADT the separate cycle track should be provided. This guidance recommends that where the roundabout carries over 8,000 AADT consideration must be given to providing off-carriageway tracks for cyclists (with 10,000 AADT considered a critical fail using the audit tool).
- Street lighting must be provided.

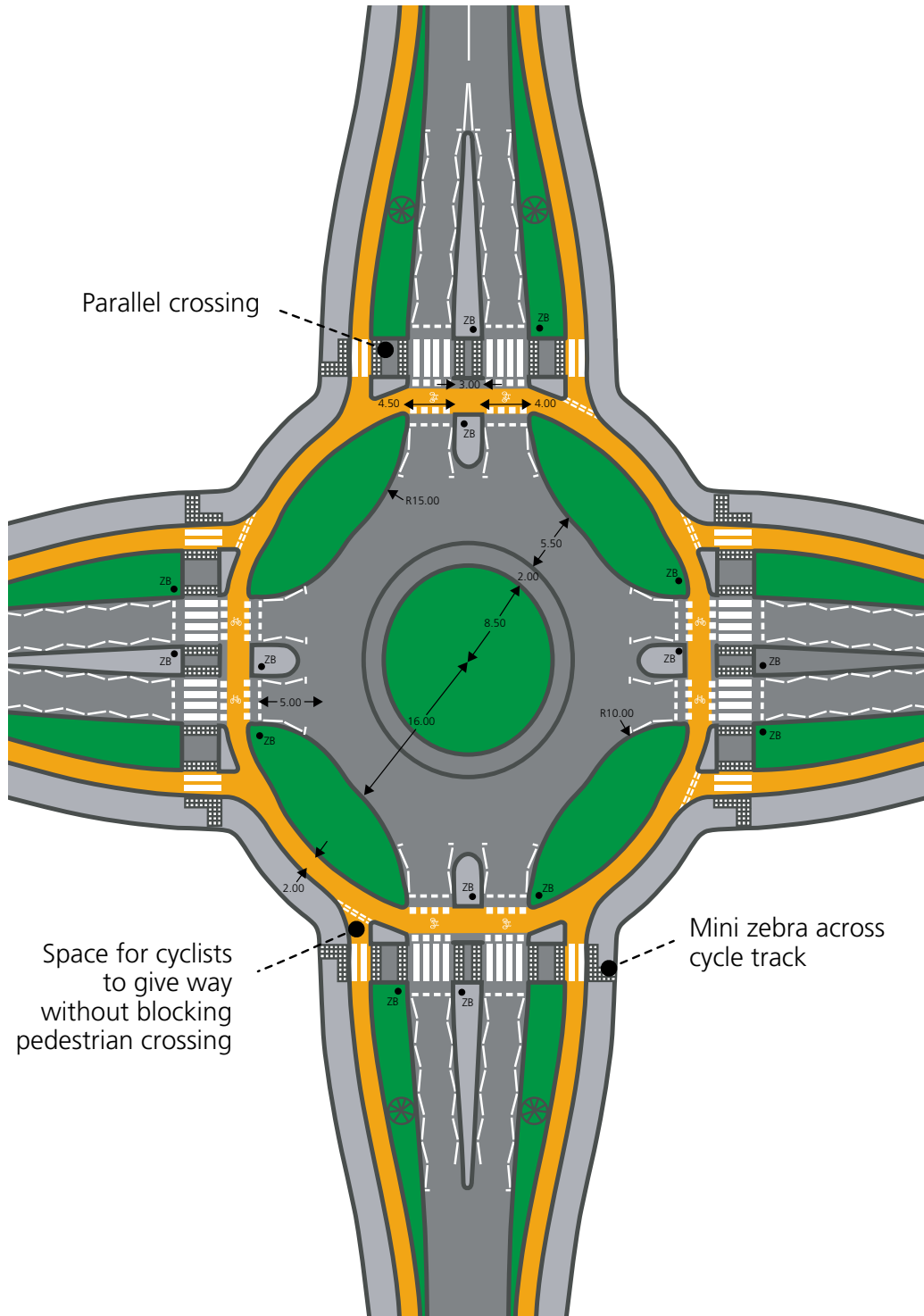

Parallel crossing

Space for cyclists to give way without blocking pedestrian crossing

Mini zebra across cycle track



DE626 Pedestrian/cycle bridge

Measure and brief description

Bridges provide useful connections for footpaths and cycle tracks, taking routes across barriers such as major roads, railways and waterways. Where the topography is favourable the need for approach ramps can be minimised. Good natural surveillance is necessary for personal security. New bridges can be attractive features along a route. New overbridges are generally cheaper than new subways/underpasses, but may involve greater height difference to ensure clearance for large vehicles.

Benefits

- Provides a conflict-free crossing of a major barrier.
- A new bridge may provide an opportunity for a landmark feature.
- A bridge will often be cheaper than a subway/underpass.

Key design features

- Bridges require considerable investment and should normally cater for both pedestrians and cyclists.
- Bridges can attract high numbers of pedestrians and cyclists and the aim should be to provide effective segregation between them so that each group can travel at their preferred speed.
- Bridge approaches and decks should be straight or nearly straight. Right angled turns are difficult for cyclists to negotiate.
- Gradients should be in accord with the maximum values given in chapter 9, depending on slope length. Steeper gradients than 7% are not recommended, except over very short distances.
- Where the topography is favourable the need for approach ramps can be minimised.
- See DE103 for Ramps, DE104 for Steps.

Dimensions

a – Overall deck width:

- Pedestrian only: A minimum width of 2m, with additional width for busy routes – refer to Pedestrian Comfort Guidelines.
- Unsegregated pedestrian/cycle bridge: the width should reflect the level and type of use forecast with a minimum of 4m width on primary cycle routes, or 3.5m on less busy secondary routes. On particularly heavily trafficked routes it should be increased to 5m.

b – Segregated pedestrian/cycle bridge, footway width:

- the width should reflect the level and type of use forecast with a minimum of 2m width, increasing to 3.5m width where there is frequent use by groups.

c – Segregated pedestrian/cycle bridge, cycle track width:

- Cycle track width should be sufficient to accommodate the forecast level of use with a minimum of:
 - » 3m where the peak hour flow is less than 50/hr;
 - » 4m on a primary cycle route (3.5m on a secondary cycle route) where it is 50-250/hr;
 - » 4.5m over 250/hr.

h - Parapet height

- Parapet height for new bridges is normally 1.15m for pedestrians, 1.4m for cyclists, 1.8m for equestrians.
- On existing structures being converted to cycle use this parapet height cannot always be achieved, but it should not necessarily preclude their use as crossings for cyclists.

Other considerations

- Similar criteria apply to the conversion of footways over road bridges to shared use facilities. Design widths should acknowledge suppressed demand and allow for growth in user numbers.
- Exposure of users to the weather should be considered – covered bridges will be beneficial.



Pedestrian only or Unsegregated

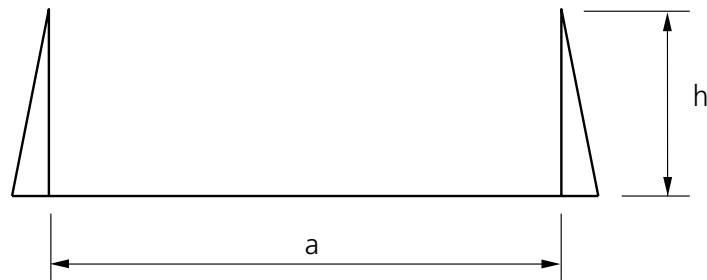

Segregated

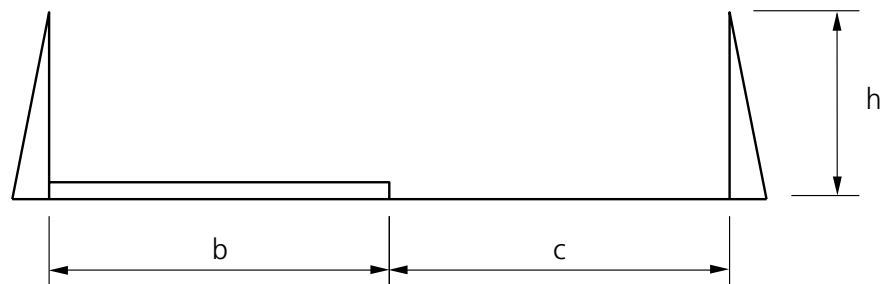

DE627 Subway/underpass

Measure and brief description

Subways/underpasses can provide very useful connections for footpaths and cycle tracks, taking routes across barriers such as railways, waterways and major roads without conflict. Where the topography is favourable the need for approach ramps can be minimised. Achieving good natural surveillance is necessary to provide personal security. This option may involve the conversion of an existing pedestrian subway or an underpass provided for private access.

Benefits

- Provides a conflict free crossing of a major barrier.
- Avoids exposure to the weather.
- The longitudinal profile of an underpass (down then up) is more comfortable for cyclists than bridges with approach ramps.

Key design features

- Subways/underpasses require considerable investment and should normally cater for both pedestrians and cyclists.
- Subways/underpasses can attract high numbers of pedestrians and cyclists and the aim should be to provide effective segregation between them so that each group can travel at their preferred speed.
- Approaches and the structures themselves should be straight or nearly straight. Right angled turns are difficult for cyclists to negotiate.
- Gradients should be in accord with the maximum values given in chapter 9, depending on slope length. Steeper gradients than 7% are not recommended, except over very short distances.
- Where the topography is favourable the need for approach ramps can be minimised.
- Lighting should be provided and be vandal proof.
- Corners and recesses should be avoided, with the exits being visible to users on entry.
- Natural lighting should be maximised by the use of generous widths, angled sides to the structure and light wells on longer crossings.
- See DE103 for Ramps, DE104 for Steps.

Dimensions

- Subways for pedestrians require headroom (h1) of at least 2.3m (2.6m for lengths over 23m) and a width (w1) of 3m (2.3m for light use).
- Subways for use by cyclists require headroom (h1) of 2.4m (2.7m for lengths over 23m) and width (w1) of at least 4m (3m for light use) if unsegregated.
- Segregated: the width for pedestrians (w2) should be at least 2m, the cycle track (w3) 2.5m and the margin strip (w4) 0.5m. Headroom for cyclists (h2) and pedestrians (h3) as above.
- A headroom of 3.7m is required if the routes is to be used by mounted equestrians.

Other considerations

- The headroom in existing pedestrian subways is typically 2.3m; the slightly sub-standard height for cyclists should not lead to automatic rejection of a proposal to permit cycling. There are many examples of structures on public roads and on traffic free routes with headroom well below 2.4m, which operate without incident for cyclists. Any restricted headroom should be clearly signed. The 'cyclists dismount' sign should not be used.
- Exit must be visible on entering the subway.
- Generous headroom and width are beneficial due to better natural surveillance and personal security. Poor lighting and sightlines will offer poor personal security.
- Barriers to slow cyclists should not be used as these can restrict access for non-standard cycles.

**Note:**

Sloping sides preferred to increase natural light and improve personal security

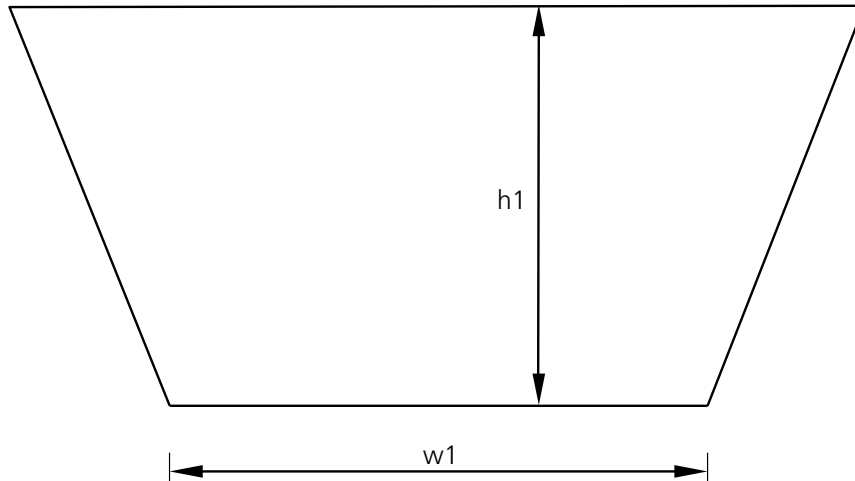

Pedestrian only or Unsegregated

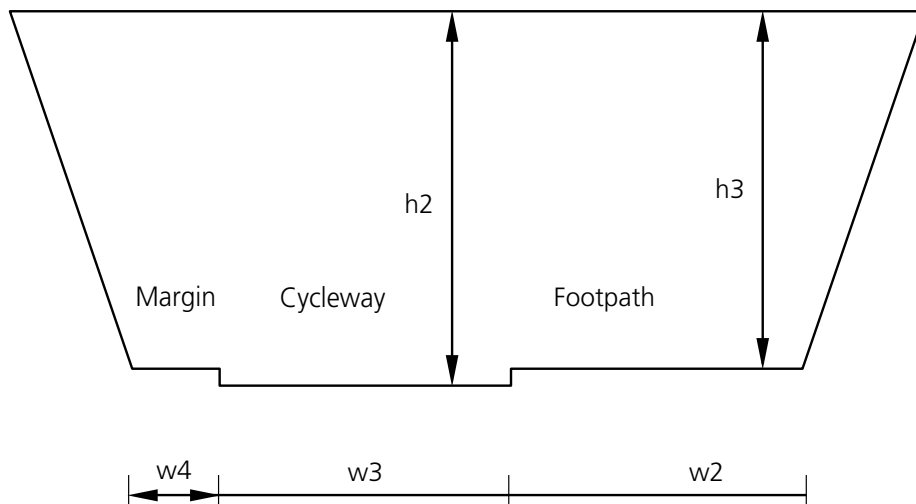

Segregated



Appendix H

Audit Tools

This section provides a guide for those using the walking and cycling audit tools for the first time. It also gives clarification and suggests sources of information that may be useful in establishing scores, including relevant references to sections within the guidance.

Walking and cycling route audit tools - [download audit tool](#)

Using the audit tools

The aim of the walking and cycling audit tools is to ensure a consistent approach to the method for assessing active travel routes across Wales. The tools consider indicators that contribute towards achieving the five key principles of an active travel route (comfort, safety, directness, coherence and attractiveness).

The tools are intended for use after route alignments have been proposed, although many of the indicators – particularly those relating to coherence and directness - are likely to have already been considered at the network development and mapping stages.

The walking tool is scored out of 20 indicators (with one non-scored), and the cycling tool of 25 indicators. Each indicator is scored out of a maximum of 2 points, with a maximum of 40 points available for walking routes, and 50 available for a cycling route. These scores are then converted to percentages to establish if a route is a 'pass' or 'fail', as shown below.

Score (%)	Pass fail
80%	Pass (desirable score)
70%	Pass
60 – 69%	Fail (but may be eligible to be passed with a statement)
60% or below	Fail
Any score with a critical fail	Fail

There are 'critical' factors marked against some of the indicators, further detail on the procedures related to these factors are explained in chapter 10 of the guidance, though in summary, for walking a 'critical fail' should be applied if there are dropped kerbs and tactile paving absent along the route (making the route inaccessible to users with some mobility aids), or cycling if the route is on-highway and vehicle flows (including percentage of HGVs) or speeds are above a certain threshold, or if the route is below the recommended widths for the type of infrastructure for more than 50% of the route length.

Individual scoring indicators may not be applicable to every active travel route, for example, indicator 7 of the walking audit tool only relates to routes with a staggered crossing facility. Where the element is not applicable to the route, it should be marked as 'n/a' and the overall scoring total reduced by 2 points, as shown below.

Walking score example	
Overall score	27 out of 40
Number of elements not applicable to the route	3
Total points to be reduced	6
Overall score (revised)	27 out of 34
Percentage	79% (pass)

An additional example using the cycle audit tool for routes away from the highway is that indicators 9–12 may not be required as the routes do not interact with vehicle traffic.

Cycling score example	
Overall score	35 out of 50
Number of elements not applicable to the route	4
Total points to be reduced	8
Overall score (revised)	35 out of 42
Percentage	83% (pass - desirable)

Some indicators may already have useful quantitative data available from relevant local authority departments (e.g. previous traffic counts, speed surveys or records of highway works completed on or near to a route).

Factors may also be assessed by desktop study before undertaking the route audit, but these should be confirmed as accurate whilst undertaking the on-site audits. To qualify for inclusion on the ATNM as an existing route, an audit must have been undertaken on site.

A number of the indicators are fairly subjective and this should be taken in to consideration as part of the audit process. Audits should preferably therefore be carried out by the same person or team depending to provide consistency. If a number of different people are to carry out the audits then regular bench-marking or feedback between auditors should take place to assure consistency across the area.

Walking audit tool

The walking audit tool is intended to be undertaken by an auditor who is a pedestrian at the time of assessing the route. Assessors will need to be mindful to audit as a pedestrian under the definition of the act (e.g. pedestrian on foot and/or with a mobility aid, such as a wheelchair or mobility scooter). Auditors should travel the route in both directions and note the time and date of the audit.

The table below provides references to relevant sections within the guidance for each of the factors.

A rule of thumb to assist with the scoring for each of the subjective factors is:

- If overwhelmingly negative (0)
- If balanced (1)
- If overwhelmingly positive (2)

Principle	Factors	Things to look out for/useful sources (as well as engagement/consultation feedback)
Attractiveness	1 – Maintenance	Examples described within tool.
	2 – Fear of crime	Are people using the route at the time of audit? Is there a mix of uses/destinations to encourage use at various times of day? Are there buildings with windows looking onto the route? Is there any evidence of anti-social behaviour?
	3 – Traffic noise and pollution	Is there a constant noise from various sources of heavy traffic? Is there traffic noise for more than 50% of the time whilst on the audit? Is there occasional traffic noise from passing vehicles?
	4 – Other	Is there anything relevant to the route alignment that impacts upon the attractiveness of the route? (examples described within tool) e.g. negative factors such as poorly lit or high usage of guardrail/bollards, or positive such as good lighting or well-maintained planters
Comfort	5 – Condition	Examples described within tool. Pedestrian comfort tool also useful.
	6 – Footway width	Relevant widths described within tool. Pedestrian comfort tool also useful.
	7 – Width on staggered crossings/refuges	Relevant widths described within tool. Pedestrian comfort tool also useful.
	8 – Footway parking	Examples described within tool.
	9 – Gradient	Gradient data may be available via topographical maps at desktop study stage. Mapping software tools can help to establish this.
	10 – Other	Is there anything relevant to the route alignment that impacts upon the comfort of the route? (examples described within tool)

Principle	Factors	Things to look out for/useful sources (as well as engagement/consultation feedback)
Directness	11 – Footway provision	Does the footway align with the origin/destination points? Desktop mapping software can help to confirm the deviation factor or a route against the nearest straight-line alternative.
	12 – Location of crossings in relation to desire lines	Relate back to origin/destination mapping in ATNM. Do the crossing points cater for these movements? Is there evidence of users crossing outside of these facilities whilst on the audit?
	13 – Gaps in traffic	Not applicable if crossings on desire lines accommodated for via controlled facilities (see factor 14/15) Can be established on-site using a stopwatch (consider time of day and route context)
	14 – Impact of controlled crossings	Not applicable if no controlled crossings (see factor 13) Island waiting time can be established on-site using a stopwatch (consider time of day and route context)
	15 – Green signal time	Not applicable if no signal-controlled crossings (see factors 13/14)
	16 – Other	Is there anything relevant to the route alignment that impacts upon the directness of the route? (examples described within tool)
Safety	17 – Traffic volume	Check by desktop study; traffic counts/flows may have been conducted previously along route section by LA, or by external company, e.g. as part of a development's access/egress statement. Can be confirmed on site. Alternatively, an on-site cordon count can be undertaken (consider context of route and time/day).
	18 – Traffic speed	Should be based upon actual speeds, rather than stated limit along the route. Check by desktop study, traffic counts/flows may have been conducted previously along route section by LA, or by external company, e.g. as part of a development's access/egress statement.
	19 - Visibility	Street furniture should contrast with background materials to increase visibility (consider daylight and darkness).
Coherence	20 – Dropped kerb and tactile paving	Are the tactiles provided in line with recommendations, e.g. correct markings, opposite one another? Critical factor Would this route be accessible to a wheelchair user/mobility scooter user?
	21 – Signage	Not a scored factor, but will need to be proportionate to route context, e.g. local residential may require a different approach

Cycling audit tool

As with the walking audit tool, assessors will need to undertake the audit as a cyclist under the definition of the act, including a consideration of the dimensions of adapted cycles.

It is advised auditors should cycle the route to get a feel for the route as a cyclist, before travelling the route as a pedestrian to annotate the audit form. If proposed as a bi-directional alignment, auditors should travel the route in both directions. Auditors should note the time/date of the assessment.

The table below provides references to relevant sections within the guidance for each of the factors.

A rule of thumb to assist with the scoring for each of the subjective factors is:

- If overwhelmingly negative (0)
- If balanced (1)
- If overwhelmingly positive (2)

Principle	Factors	Things to look out for/useful sources (as well as engagement/consultation feedback)
Cohesion	Connections	An overview map, showing the context of the area, may help to understand likely route connections from the alignment being audited. Consider if turning/connected facilities suitable for cyclists.
	Continuity/wayfinding	Examples provided within description, look out for advisory dismount signage and if markings are provided where confusion as to alignment may arise, e.g. through junctions.
	Density of network	Establish using desktop study before or after the audit takes place (confirming accurate whilst on site).
Directness	Distance	As above.
	Time: frequency of required stops or give ways	To confirm locations of stops or give ways along route on site visit, can be calculated via desktop measurement tools in relation to the length of route.
	Time: delay at junctions	To confirm delay of timings whilst on route, can try the lights and movements across the junction with stop-watch (provided there is a safe location to start/stop timing).
	Time: delay on links	To confirm whilst on audit. Consider ability to pass queued traffic, for example.
	Gradients	Gradients can be considered by desktop study and confirmed on site. Should be considered in both directions if bi-directional route.

Principle	Factors	Things to look out for/useful sources (as well as engagement/consultation feedback)
Safety	Reduce/remove speed differences where cyclists are sharing the carriageway (junction)	May not be applicable to some traffic-free routes, but will be relevant where cyclists are required to cross at a junction. Should be based upon actual speeds, rather than stated limit along the route. Check by desktop study, traffic counts/flows may have been conducted previously along route section by LA, or by external company.
	Avoid high motor traffic volumes where cyclists are sharing the carriageway (route)	As above, except refers to speeds along the alignment rather than at junctions/crossings.
	Risk of collision (route)	Check by desktop study, traffic counts/flows may have been conducted previously along route section by LA, or by external company, e.g. as part of a development's access/egress statement. Can be confirmed on site. Collision data may be useful to evidence.
	Risk of collision (junction)	Confirm whilst on audit the provision for cyclists at junctions, including side roads. Are there large corner radii? Are vehicle speeds reduced through the junction via mitigation methods (e.g. traffic calming)? Are cycle movements separated from motor vehicle movements through major junctions. Collision data may be useful to evidence.
	Avoid complex design	Are the road markings in place sufficient to illustrate potential movements, are the markings faded or worn? Is there complex or unusual movements associated with negotiating the route or junction?
	Consider and reduce risk from kerbside activity	Are cycle lanes widths less than 1.5m (including buffers for parking/loading)? Do cycle lanes adjacent to parking bays allow enough room for manoeuvre from a car door if opened? Are there features along the route that cyclists may become trapped against (e.g. guardrails)?
	Reduce severity of collisions where they do occur	Are there any features adjacent to the route that would not allow a cyclist to take evasive action (e.g. wall directly adjacent to a minimum recommended width route)? If so, consider the score against the length of the route section this applies to.

Principle	Factors	Things to look out for/useful sources (as well as engagement/consultation feedback)
Comfort	Surface quality (defects)	Descriptions within audit tool.
	Surface quality (type)	Descriptions within audit tool.
	Effective width (without conflict)	Consider the route, and type of provision, against the minimum desirable values. May need to assess flows to ensure widths provided are sufficient for the route's context.
	Wayfinding	This element relates only to the provision of signage relevant to the route and whether this is of high quality (signage clutter is considered separately within the Attractiveness principle).
Attractiveness	Social safety and perceived vulnerability of user (lighting)	Ideally, particularly if a route is likely to be used often at night, a route should be audited in both the daylight and at night. If an audit is only undertaken in the day, check if lighting columns/posts/in-ground are provided.
	Social safety and perceived vulnerability of user (isolation)	Are people using the route at the time of audit? Are there a mix of uses/destinations to encourage use at various times of day? Are there buildings with windows looking onto the route? Is there any evidence of anti-social behaviour?
	Impact on pedestrians, Including people with disabilities	Is there evidence of conflict, or high potential for conflict between cyclists and pedestrians? If also a pedestrian alignment, refer to pedestrian audit findings relating to the comfort guidance tool
	Minimise street clutter	This relates to signage along the route, not necessarily relating to cycle-specific signs. The main query relates to if the signage a cyclist needs is clear, or if it is difficult to identify against signage clutter (e.g. other directional signage, redundant, out of date or overbearing sign-age, inappropriately placed advertising signage).
	Secure cycle parking	Consider cycle parking stand usage whilst on audit (if applicable).

Appendix I

Introduction

Legal procedures

The diagram below sets out the main legal frameworks for the construction and maintenance of active travel routes and facilities in addition to the Active Travel Act.

Highways Act 1980	Road Traffic Regulation Act 1984	Cycle Tracks Act 1984	Town and Country Planning Act 1990
s.24 Construction of New Highways	s.1-5 Traffic regulation orders <ul style="list-style-type: none"> • prohibitions of traffic or classes there of • mandatory cycle lanes • bus lanes • one way streets • prohibited and prescribed manoeuvres • contra-flow bus lanes & bus gates • prohibitions of waiting stopping and loading 	s.3 Conversion of footpaths to cycle tracks	s.249 Pedestrian streets Where not enacted under the RTRA 84
s.41 Maintenance of Highways	s.23-25 Pedestrian crossings <ul style="list-style-type: none"> • zebra crossings • NOT toucan crossings 	s.4 Provisions of barriers etc in cycle tracks Access control on cycle tracks	
s.65 – Construction of cycle tracks adjacent to carriageways	s.32-63A Parking places cycle parking other parking and loading places		
s.90A-90F Road humps	s.64-80 Traffic signs Also toucan crossings & traffic signals		

Highways Act 1980	Road Traffic Regulation Act 1984	Cycle Tracks Act 1984	Town and Country Planning Act 1990
s.90G-90I Other traffic calming Traffic Calming Hybrid Mandatory Cycle Lanes Bicycle Streets	s.81-91 Speed limits		
s.97 Lighting	s.92-93 Bollards <ul style="list-style-type: none"> • Access control in 		

Highways Act 1980

Section 62 – General Improvements: The provisions of this Part of this Act empower or require highway authorities and other persons to improve highways. Any such authority may carry out, in relation to a highway maintainable at the public expense by them, any work (including the provision of equipment) for the improvement of the highway. Section 62 covers any of the following descriptions:

- the division of carriageways, provision of roundabouts and variation of the relative widths of carriageways and footways
- the construction of cycle tracks
- the provision of subways, refuges, pillars, walls, barriers, rails, fences or posts for the use or protection of persons using a highway
- the construction and reconstruction of bridges and alteration of level of highways
- the planting of trees, shrubs and other vegetation and laying out of grass verges
- the provision, maintenance, alteration, improvement or other dealing with cattle-grids, by-passes, gates and other works for use in connection with cattle-grids
- the construction, maintenance and removal of road humps
- the construction and removal of such traffic calming works as may be specially authorised by the Secretary of State under section 90G below or prescribed by regulations made by him under section 90H below
- the execution of works for the purpose of draining a highway or of otherwise preventing surface water from flowing on to it
- the provision of barriers or other works for the purpose of affording to a highway protection against hazards of nature

- A highway authority may alter or remove any works executed by them under this section Section 65 – Construction of cycle tracks adjacent to carriageways: Empowers highway authorities to provide cycle tracks within or next to highways including a carriageway (i.e. a street). This is not suitable for footpaths (i.e. where the only right of way across the entire width of the highway is by foot). There are no statutory requirements regarding the exercise of this power, although there needs to be evidence that the Highway Authority has exercised this power, particularly given such schemes may be contentious. The erection of the appropriate traffic signing will perform this role to an extent, though it is recommended that any conversion is formally made by a resolution of the relevant council committee, following consultation and engagement with stakeholders.

Where a cycle track is proposed adjacent to a highway, but outside its adopted limits, this can be achieved by constructing a cycle track under section 65(1) of the Highways Act as a permitted development under Part 13 of Schedule 2 of the Town and Country Planning (General Permitted Development) Order 1995 (HMSO, 1995).

Sections 90A-90F (Road humps) allows Highway Authorities to construct road humps. Their design and installation is regulated by the Highways (Road Humps) Regulations 1999 (HMSO, 1999b). Advice relating to good practice and legal requirements with respect to de-sign can be found in Section 4 of LTN 1/07 Traffic Calming (Department for Transport, 2007a).

Section 90C (1) of the Highways Act 1980 requires that the Chief Officer of Police is consulted before road humps are installed. Sections 90C (2)&(5) of the same Act require authorities carry out the following procedure before installing road humps:

- notices should be placed in local press and on-street, detailing each individual road hump proposed and inviting objections before a stated deadline not less than 21 days after the publication of proposals
- any objections received should be considered by the Highway Authority. Typically objections will be considered by the relevant committee of the Council

Regulation 3 of the Highways (Road Humps) Regulations 1999 requires that the following bodies are consulted in addition to those above:

- the Chief Officer of the fire brigade
- the Chief Officer of any body providing ambulance services
- any organisations appearing to the authority to represent persons who use the highway to which the proposal relates, or to represent persons who are otherwise likely to be affected by the road hump

Section 90G-90I (Other traffic calming) allows highway authorities to construct other traffic calming measures. These measures are regulated by the Highways (Traffic Calming) Regulations 1999 (HMSO, 1999a), which permit the following measures:

- build-outs
- chicanes
- gateways
- islands
- over-run areas
- pinch points
- rumble devices
- combinations of the above

The regulations impose limits on the design of over-run areas and rumble devices. Section 5 of LTN 1/07 Traffic Calming (Department for Transport, 2007a) offers design advice – additional care should be taken to ensure such features do not pose a hazard to cyclists.

Section 97 (Lighting) empowers highway authorities to provide lighting on highways, including cycle tracks. There is no prescribed procedure for providing such lighting.

Appendix J

Network planning background information

Successful integration with other policies, plans and programmes will deliver better active travel schemes more quickly. These plans might include

- Transport and land use plans:
 - existing walking, cycling or active travel strategies and plans
 - plans or proposals for the development of non-vehicular routes, quiet lanes, home zones or traffic calming
 - strategic bus plans or schemes
 - rights of way improvement plans
 - traffic management plans
 - city centre management plans
 - any Network Rail or Transport for Wales plans such as new stations, station improvements or changes to bridges or level crossings as part of the proposed electrification of the lines
- Road safety strategies and schemes:
 - Safe Routes in Communities schemes
 - plans and strategies by third parties that include infrastructure provision for active travel
 - local development plans (including supplementary planning guidance and masterplans)
 - local transport plans
 - Wales Transport Strategy
 - highway maintenance plans
 - any plans for new highways (e.g. linking to new development sites)
- Other local authority plans and strategies that could include:
 - schools

- tourism
- countryside
- public rights of way
- highway maintenance
- access officers

Integration with policy and promotion measures

The plans also need to be integrated within a wider programme of measures to improve facilities for active travel. The following non-infrastructure measures should be considered in conjunction with any walking and cycling improvement schemes:

- ensure that planning policy guides new development towards sustainable locations that maximise the potential for walking and cycling trips
- ensure that transport policy and highway development control processes result in new development site layouts that are designed to maximise access on foot and cycle
- ensure that the needs of pedestrians and cyclists are considered when implementing any changes to highway infrastructure
- encourage travel plans, which provide a strategy and action plan for facilitating and encouraging travel by sustainable modes, from all significant developments through the planning process
- explore the potential for new larger-scale developments to fund walking and cycling audits within adjacent neighbourhoods, potentially secured through section 106 agreements
- promotion of active travel through measures such as:
 - production and dissemination of public walking and cycling maps, which should also provide information on public transport
 - organised activities for specific user groups, such as 'walk/bike to school month'
 - dissemination of publicity regarding the potential health and financial benefits of regular active travel
- work with partners in the health sector to develop walking and cycling-based initiatives to help meet shared objectives for active travel

National data sources for network planning

There is a broad range of publicly available data which can usefully input into the development of an Active Travel Network Map, including:

- ward boundary map
- census – ward-to-ward travel to work data by mode
- NOMIS ward-to-ward travel to work patterns
- demographic profile maps
- residential and workplace population data
- cycling to work data
- cycle collision data (e.g. www.crashmap.co.uk)
- road network hierarchy
- [Department for Transport – traffic counts Wales](#)
- traffic and cycle count location plan
- traffic and cycle flow data
- [Welsh Index of Multiple Deprivation](#)

Local data sources for network planning

Local authorities already collect a range of data which can usefully input into the cycle network plan including:

- locally collected traffic and cycle count location plan
- locally collected traffic and cycle flow data including off road cycle counters
- locally collected traffic speed data
- data collected as part of travel plans for specific organisations within the settlement
- existing traffic calmed streets
- housing monitoring maps

Origins and destinations to be mapped in the Active Travel Act

For the Active Travel Act the following departure and destination points need to be mapped as part of the production of the ATNM:

- major office locations, employment sites and business parks
- public transport nodes
- libraries
- post offices
- sports stadia
- leisure centres
- parks
- religious buildings
- hospitals
- shopping centres and major retail destinations
- all schools and educational establishments
- cultural institutions
- tourist advice centres
- tourist and leisure attractions
- recreational walking and cycling routes
- cycle maintenance and repair shops

Data sources and tools to assist in prioritisation

Service/data	Purpose
<u>PCT (National Propensity to Cycle Tool – Free web tool)</u>	Estimates cycling potential based on existing levels and demographic data
<u>sDNA (Spatial Design Network Analysis – Cardiff University)</u>	Visualises current flows of cyclists, identifies accessibility issues and predicts future new route usage
<u>Data Shine (UCL – Free web based)</u>	Displays how many people cycled between various urban zones to show where the biggest demand for cycling is
<u>Strava Metro network usage data (Strava)</u>	Uses crowd-sourced cycling usage data to show how people navigate through geographic areas

Appendix K

Example prioritisation process

The scoring matrix included below has been developed from the approach used by Bridgend County Borough Council during the prioritisation of its previous active travel proposals. It was originally adapted from a matrix developed by Local Transport Projects Limited and has been used in Cardiff and across the wider south-east Wales region.

The matrix contains 26 separate scoring elements, related to the benefits and accessibility improvements which it is anticipated that schemes will deliver. It is intended that the matrix will provide a mechanism to assist local authorities to identify which schemes are likely to have the greatest impact, and therefore should be prioritised for development and delivery.

When scoring the schemes, the route should be assessed in terms of its potential to cater for a whole journey, particularly in terms of linking to services and facilities. Details of the criteria that should be used as the basis for scoring each element of the matrix are included in the tables.

Table K1: Example prioritisation factors matrix

Table K2: Example prioritisation scoring matrix

Table K3: Benefits scoring system

Active travel guidance: prioritisation example templates to download:

<https://gov.wales/active-travel-guidance-prioritisation-matrix-appendix-k>

Useful resources

Vision and Priorities

Welsh Government (2021) [Llwybr Newydd: the Wales Transport Strategy 2021](#)

Chapter 2: The duties on local authorities and Welsh Ministers

National Assembly for Wales (2013) [Active Travel \(Wales\) Act](#)

UK Government [Highways Act 1980](#)

Welsh Government [Data Map Wales](#)

Chapter 3: Policy and legislative context

Equality and Human Rights Commission [Public Sector Equality Duty in Wales](#)

National Assembly for Wales (2006) [Transport \(Wales\) Act 2006](#)

National Assembly for Wales (2015) [Well-being of Future Generations \(Wales\) Act](#)

National Assembly for Wales (2016) [Environment Act \(Wales\)](#) and [factsheets](#)

Sustrans (2019) [Bike Life Report](#)

UK Government [Equality Act 2010](#)

UK Government (2010) [Flood and Water Management \(Wales\) Act](#)

Wales Statutory Instruments [The Equality Act 2010 \(Statutory Duties\) \(Wales\) Regulations 2011](#)

Welsh Government (2008) [Learner Travel \(Wales\) Measure](#)

Welsh Government (2017) [Welsh transport appraisal guidance \(WelTAG\)](#)

Welsh Government (2021) [Planning Policy Wales](#)

Welsh Government (2020) [Clean air plan for Wales: Healthy air, healthy Wales](#)

Welsh Government (2019) [Low carbon delivery plan](#)

Welsh Government (2019) [Healthy weight healthy Wales](#)

Welsh Government (2019) [Action on disability: the right to independent living](#)

Welsh Government (2021) [Future Wales: the national plan](#)

Welsh Government (2021) [Llwybr Newydd: the Wales Transport Strategy 2021](#)

Chapter 4: Network principles and requirements

National Assembly for Wales (2013) [Active Travel \(Wales\) Act](#)

Sustrans (2016) [Key walking and cycling statistics for the UK](#)

Welsh Government (2021) [Planning Policy Wales](#)

Chapter 5: Consultation, engagement and promotion

[Wales Council of the Blind](#)

Chapter 7: Introduction to planning and design

Department for Transport (2007) [Manual for Streets](#)

Department for Transport (2016) [Traffic Signs Regulations and General Directions \(TSRGD\)](#)

Standards for Highways [Design Manual for Roads and Bridges \(DMRB\)](#)

Standards for Highways (2019) [GG142 Walking, cycling and horse-riding assessment and review \(WCHAR\)](#)

UK Government [Highways Act 1980](#)

UK Government [Road Traffic Regulation Act 1984](#)

Welsh Government (2021) [Procedure and Advice Guidance \(PAG\) 115/20: Active Travel and Trunk Road Improvement Schemes](#)

Welsh Government (2017) [Welsh transport appraisal guidance \(WelTAG\)](#)

Welsh Government (2021) [Planning Policy Wales](#)

Welsh Government (2020) [Compulsory purchase in Wales and 'The Crichef Down Rules' Circular 003/2019](#)

Chapter 8: Engagement and consultation methods

[Commonplace](#)

Living Streets [WOW - The walk to school challenge](#)

Sustrans [Active Journeys](#)

UK Government [Equality Act 2010](#)

Welsh Government (2018) [Children and young people's national participation standards](#)

Chapter 9: User needs

Adams T & Aldred R (2020) [Cycling Injury Risk in London: Impacts of Road Characteristics and Infrastructure Findings Press](#)

Arup and Sustrans (2019) [Inclusive design in cities and towns](#)

British Standards Institution (2018) – [BS 8300 Design of an accessible and inclusive built environment. Buildings. Code of practice.](#)

Chartered Institution of Highways and Transportation (2015) [Designing for Walking](#)

CROW (2016) [Design Manual for Bicycle Traffic](#). Cycling Embassy of Denmark

Cycling Embassy of Denmark [Collection of Cycle Concepts](#) (2012)

Equality and Human Rights Commission (2017) [Equality impact assessments: advice and guidance for public bodies in Wales](#)

Department for Transport (2016) [Traffic Signs Regulations and General Directions \(TSRGD\)](#)

Department for Transport [Traffic Signs Manual](#)

Department for Transport (2005) [Inclusive Mobility](#)

Department for Transport (2007) [Guidance on the use of Tactile Paving Surfaces](#)

Department for Transport (2007) [Manual for Streets](#)

Department for Transport (2012) [Code of Practice – street works and road works](#)

Department for Transport [Detailed statistics about reported personal injury road accidents for Great Britain, vehicles and casualties involved](#)

Department for Transport [National standard for cycle training](#)

Living Streets (2013, updated 2018) [The pedestrian pound – the business case for better streets and places, London.](#)

National Federation of the Blind of the UK (2013) [Access For Blind People In Towns. SS1401.](#)

Philips I , Anable J & Chatterton T CREDS (2020) [E-Bike savings, how much and where?](#)

Standards for Highways [Design Manual for Roads and Bridges \(DMRB\)](#)

Sustrans (2020) [Planning for e-cargo bikes](#)

Transport for London (2019) [Pedestrian Comfort Guidance for London.](#)

Transport for London (2017) [Healthy Streets for London: Prioritising walking, cycling and public transport to create a healthy city](#)

Transport Research Lab (TRL) [Cycling in vehicle restricted areas \(2003\)](#)

UK Research Council Equality [Impact Assessment Guidance and Template](#)

Chapter 10

Department for Transport (2020) [Cycle Infrastructure Design – LTN 1/20](#)

Department for Transport (2017) [Local cycling and walking infrastructure plans](#)

Lovelace, R (2017) [Journal of Transport and Land Use: The propensity to cycle tool: An open source online system for sustainable transport planning](#)

National Statistics (2011) [Census: Detailed characteristics on travel to work](#)

[Propensity to Cycle Tool](#)

See also [Appendix J](#)

Chapter 11

Department for Transport (2016) [Traffic Signs Regulations and General Directions \(TSRGD\)](#)

Sustrans [Traffic-free routes and greenways design guide](#)

Chapter 12

Department for Transport (2007) [Manual for Streets](#)

Department for Transport (2016) [Traffic Signs Regulations and General Directions \(TSRGD\)](#)

Department for [Transport Traffic Signs Manual](#)

Standards for Highways [Design Manual for Roads and Bridges \(DMRB\)](#)

Webb, EA, Bell S, Lacey, RE, Abell JG (2017) UCL [Crossing the road in time : Inequalities in older people's walking speeds](#)

Chapter 13

Department for Transport (2015) [Design Standards for Accessible Railway Stations](#)

Rail Delivery Group (2016) [Cycle-Rail toolkit 2](#)

Chapter 14

Bicycle Association (2021) [Standards for public cycle parking](#)

Living Streets [Community Street Audits](#)

Living Streets (2011) [Making the case for investment in the walking environment](#)

Living Streets (2019) [Journal of Litter and Environmental Quality](#)

British Standards Institution (2018) – [BS 8300 Design of an accessible and inclusive built environment. Buildings. Code of practice.](#)

Department for Transport (2007) [Manual for Streets](#)

Department for Transport (2005) [Inclusive Mobility](#)

Sign Design Society and the Royal National Institute of Blind People (2000) [Sign Design Guide – a guide to inclusive signage.](#)

Tree and Design Action Group (2014) [Trees in Hard landscape: A Guide for Delivery.](#)

Welsh Government (2018) [Traffic signs and road markings](#)

Chapter 15

Department for Transport (2005) [Inclusive Mobility](#)

Department for Transport (2007) [Guidance on the use of Tactile Paving Surfaces](#)

Department for Transport (2013) [Safety at street works and road works : a code of practice \(The Red Book\)](#)

Department for Transport [Traffic Signs Manual](#)

Transport for London (2013) [Cycling Design Standards](#)

Sustrans (2019) [Traffic-free routes and greenways design guide](#)

Welsh Government (2018) [Statutory standards for sustainable drainage systems and Statutory Guidance](#)

Welsh Government (2021) [Procedure and Advice Guidance \(PAG\) 115/20: Active Travel and Trunk Road Improvement Schemes](#)

Chapter 16

Hills, D. (2010) Tavistock Institute [Logic mapping: hints and tips](#)

Sustrans, (2019) [Cardiff Bike Life Report](#)

Photo and figure credits

Welsh Government is grateful to the following organisations for their permission to use image photography and/or technical details.

Where not otherwise credited photography was commissioned by Welsh Government from Jon Bewley [photojb](#) or images have been supplied by Transport for Wales from their photography library.

Vision and priorities

Living Streets – unlabelled photograph on page 11

Arup/Math Roberts Photography – unlabelled photograph on page 13

Chapter 5

Sustrans – figure 5., unlabelled photograph at end of chapter

Chapter 8

Powys County Council - figure 8.1

Commonplace – figure 8.2

Chapter 9

Crispin Hughes - figure 9.6

[CROW](#), Netherlands – table 9.7

Department for Transport – figures 9.9, 9.11, 9.13. Tables 9.2, 9.3, 9.6

Newport City Council – figure 9.7

Pedal Power Cardiff – figure 9.4

Phil Jones Associates – figures 9.13, 9.14, 9.15, 9.16

Sustrans – figures 9.1, 9.2, 9.3

Chapter 10

Arup/Math Roberts Photography – unlabelled photograph at end of chapter

Welsh Government DataMapWales – figure 10.3

Phil Jones Associates – figure 10.4

Chapter 11

Department for Transport – figure 11.18, table 11.1

Sustrans – figure 11.1, 11.19, table 11.6

John Mather – figure 11.6

Phil Jones Associates 11.17

Chapter 12

Department for Transport – figure 12.1, 12.3, table 12.1

Sustrans – figures 12.9, 12.19, 12.21, 12.30

Phil Jones Associates – figures 12.2, 12.5, 12.7, 12.25

Cambridge City Council – figure 12.24

Chapter 13

Cardiff Bus – figure 13.5

London Borough of Waltham Forest - figure 13.4

Visit Cumbria – figure 13.2

Border Buses – figure 13.7

Chapter 14

Bicycle Association – table 14.7

Transport Initiatives - figure 14.25

Camcycle / Alasdair Massie – figure 14.26

Ceredigion County Council – figure 14.30

Sustrans – figures 14.9, 14.28

Chapter 15

Sustrans – figure 15.3

Chapter 16

Sustrans – figure 16.2

Design and typesetting by Waters Creative Ltd.

Translation by Cymen Cyf.



Llywodraeth Cymru
Welsh Government